

Sprint[®]



**Sprint Power VisionSM Smart Device
MogulTM by HTC**

www.sprint.com

© 2007 Sprint Nextel. All rights reserved. SPRINT, the NEXTEL name and logo, and other trademarks are trademarks of Sprint Nextel.

Printed in the U.S.A.

Please Read Before Proceeding

THE BATTERY MUST BE CHARGED BEFORE YOU CAN USE THE DEVICE.

DO NOT REMOVE THE BATTERY PACK WHEN THE DEVICE IS CHARGING.



YOUR WARRANTY IS INVALIDATED IF YOU OPEN OR TAMPER WITH THE DEVICE'S OUTER CASING.

PRIVACY RESTRICTIONS

Some countries require full disclosure of recorded telephone conversations, and stipulate that you must inform the person with whom you are speaking that the conversation is being recorded. Always obey the relevant laws and regulations of your country when using the recording feature of your device.

INTELLECTUAL PROPERTY RIGHT INFORMATION

Copyright © 2008 High Tech Computer Corp. All Rights Reserved.

   and ExtUSB are trademarks and/or service marks of High Tech Computer Corp.

Microsoft, MS-DOS, Windows, Windows NT, Windows Server, Windows Mobile, Windows XP, Windows Vista, ActiveSync, Windows Mobile Device Center, Internet Explorer, Windows Live, MSN, Hotmail, Outlook, Excel, PowerPoint, Word, and Windows Media are either registered trademarks or trademarks of Microsoft Corporation in the United States and/or other countries.

Bluetooth and the Bluetooth logo are trademarks owned by Bluetooth SIG, Inc.

Wi-Fi is a registered trademark of the Wireless Fidelity Alliance, Inc.

microSD is a trademark of SD Card Association.

Java, J2ME and all other Java-based marks are trademarks or registered trademarks of Sun Microsystems, Inc. in the United States and other countries.

Copyright © 2008, Adobe Systems Incorporated.

Copyright © 2008, Macromedia Netherlands, B.V.

Macromedia, Flash, Macromedia Flash, Macromedia Flash Lite and Reader are trademarks and/or registered trademarks of Macromedia Netherlands, B.V. or Adobe Systems Incorporated.

Copyright © 2008, JATAAYU SOFTWARE (P) LTD. All Rights Reserved.

Copyright © 2008, Dilithium Networks, Inc. All Rights Reserved.

Copyright © 2008, Tao Group Limited. All Rights Reserved.

Licensed by QUALCOMM Incorporated under one or more of the following patents:

4,901,307	5,490,165	5,056,109	5,504,773	5,101,501	5,778,338
5,506,865	5,109,390	5,511,073	5,228,054	5,535,239	5,710,784
5,267,261	5,544,196	5,267,262	5,568,483	5,337,338	5,659,569
5,600,754	5,414,796	5,657,420	5,416,797		

All other company, product and service names mentioned herein are trademarks, registered trademarks or service marks of their respective owners.

HTC shall not be liable for technical or editorial errors or omissions contained herein, nor for incidental or consequential damages resulting from furnishing this material. The information is provided "as is" without warranty of any kind and is subject to change without notice. HTC also reserves the right to revise the content of this document at any time without prior notice.

No part of this document may be reproduced or transmitted in any form or by any means, electronic or mechanical, including photocopying, recording or storing in a retrieval system, or translated into any language in any form without prior written permission of HTC.



Welcome to Sprint

Sprint and Nextel have come together offering you more choice and flexibility to do whatever you want, whenever you want.

This powerful combination brings you access to more products, more services, and more of what you need to do more of what you want. Welcome to a future full of possibility. Welcome to the new Sprint.

Welcome and thank you for choosing Sprint.

Table of Contents

Section 1

Getting Started	1
1.1 Setting Up Service	2
1.2 Your Device.....	5
1.3 Battery Information	12
1.4 Starting Up.....	14
1.5 The Today Screen	16
1.6 Programs.....	19
1.7 Settings	21

Section 2

Entering and Searching Information	23
2.1 Using the Hardware Keyboard	24
2.2 Entering Information.....	25
2.3 Using the Onscreen Keyboard.....	26
2.4 Using Letter Recognizer	27
2.5 Using Block Recognizer	28
2.6 Using Transcriber	29
2.7 Using Symbol Pad.....	30
2.8 Using Notes to Draw, Write, and Record Voice Notes	31
2.9 Searching Information	32

Section 3

Using Phone Features	33
3.1 Using the Phone	34
3.2 Making a Call	35
3.3 Receiving a Call	37
3.4 Smart Dialing	38
3.5 Using Call Forwarding.....	40
3.6 In-Call Options	41
3.7 Additional Dialing Information.....	42
3.8 Phone Settings	43
3.9 Setting Additional Service Options.....	44
3.10 Voice and Data Roaming	45
3.11 Customizing Plus Code Dialing.....	47

Section 4

Setting Up Your Device	59
4.1 Basic Settings	60
4.2 Personalizing the Today Screen.....	61
4.3 Protecting Your Device	63
4.4 Other Settings	64

Section 5

Synchronizing Information With Your Computer.....	67
5.1 About Synchronization	68
5.2 Setting Up Windows Mobile® Device Center on Windows Vista™	69
5.3 Setting Up ActiveSync® on Windows XP®	70
5.4 Synchronizing With Your Computer	71
5.5 Synchronizing via Bluetooth.....	73
5.6 Synchronizing Music and Videos.....	74

Section 6

Organizing Contacts, Appointments, Tasks, and Other Information	75
6.1 Contacts.....	76
6.2 Calendar.....	78
6.3 Tasks.....	80
6.4 Notes	82

Section 7

Exchanging Messages	85
7.1 Messaging.....	86
7.2 Text Messages	87
7.3 Setting Up Email Accounts.....	89
7.4 Using Email	91

Section 8

Working With Company Email and Meeting Appointments.....	95
8.1 Synchronizing Your Device with the Exchange Server	96
8.2 Working With Company Email	98
8.3 Managing Meeting Requests	102
8.4 Finding Contacts in the Company Directory.....	103
8.5 Email Security.....	104

Section 9

Using Windows Live 107

- 9.1 Windows Live™ 108
- 9.2 Live Messenger..... 110
- 9.3 Sending Photos to Your Windows Live Space..... 113

Section 10

Working With Documents and Files 115

- 10.1 Microsoft® Office Mobile 116
- 10.2 Adobe Reader LE 117
- 10.3 Copying and Managing Files 119
- 10.4 Using ZIP..... 121

Section 11

Getting Connected 123

- 11.1 Comm Manager..... 124
- 11.2 Connecting to the Internet 125
- 11.3 Internet Explorer Mobile 129
- 11.4 Using Bluetooth..... 130
- 11.5 Using Your Device as a Modem (Internet Sharing) 134

Section 12

Experiencing Multimedia 137

- 12.1 Using the Built-in Camera..... 138
- 12.2 Using Pictures & Videos..... 147
- 12.3 Using Windows Media Player 151

Section 13

Managing Your Device 157

- 13.1 Adding and Removing Programs..... 158
- 13.2 Using Task Manager..... 159
- 13.3 Managing Memory 161
- 13.4 Resetting Your Device..... 162
- 13.5 Checking System Information..... 163
- 13.6 Battery Saving Tips..... 164

Section 14

Using Other Applications.....165

14.1 Using Java.....166

14.2 Using Voice Speed Dial.....169

Appendix

A.1 Specifications172

A.2 Regulatory Notices174

A.3 Additional Safety Information183

Index

189

Section 1

Getting Started

In This Section

- 1.1 Setting Up Service
 - 1.2 Your Device
 - 1.3 Battery Information
 - 1.4 Starting Up
 - 1.5 The Today Screen
 - 1.6 Programs
 - 1.7 Settings
-



1.1 Setting Up Service

Setting up service on your new smart device is quick and easy. This section walks you through the necessary steps to set up your device's phone, set up your voicemail, establish passwords, and contact Sprint for assistance with your Sprint service.

Setting Up Your Voicemail

All unanswered calls to your device are automatically transferred to your voicemail, even if your phone is in use or turned off. Therefore, you will want to set up your voicemail and personal greeting as soon as your device's phone is activated.

To set up your voicemail:

1. Access the Phone screen by pressing the **Talk Key**.

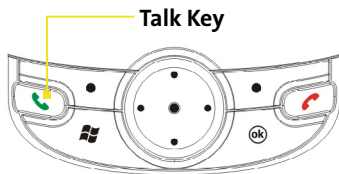

2. Press and hold the **1** key on the Phone screen.

Note: This will not work when pressing and holding the **1** key on the QWERTY keyboard.

3. Follow the system prompts to:
 - Create your passcode.
 - Record your greeting.
 - Record your name announcement.
 - Choose whether to activate One-Touch Message Access (a feature that lets you access messages simply by pressing and holding the **1** key, bypassing the need for you to enter your passcode).

Note: If you are concerned about unauthorized access to your voicemail account, Sprint recommends you enable your voicemail passcode.

Sprint Account Passwords

As a Sprint customer, you enjoy unlimited access to your personal account information, your voicemail account, and your Sprint Vision account. To ensure that no one else has access to your information, you will need to create passwords to protect your privacy.

Account Password

If you are the account owner, you'll have an account password to sign on to www.sprint.com and to use when calling Sprint Customer Service. Your default account password is the last four digits of your Social Security number. If you are not the account owner (if someone else pays for your Sprint service), you can get a sub-account password at www.sprint.com.

Voicemail Password

You'll create your voicemail password (or passcode) when you set up your voicemail. See "Setting Up Your Voicemail" for more information on your voicemail password.

Sprint Power Vision Password

With your device and Sprint Vision service, you can set up a Sprint Power Vision password. This optional password may be used to authorize purchase of Premium Services content and to protect personal information on multi-phone accounts.

For more information or to change your passwords, sign on to www.sprint.com or call Sprint Customer Service at 1-888-211-4727.

Getting Help





Visit www.sprint.com

You can go online to:

- Review coverage maps.
- Learn how to use voicemail.
- Access your account information.
- Purchase accessories.
- Add additional options to your service plan.
- Check out frequently asked questions.
- And more.

To reach Sprint Customer Service:

You can reach Sprint Customer Service many different ways:

- From the Phone screen, dial    .
- Sign on to your account at www.sprint.com.
- Call us toll-free at 1-888-211-4727 (Consumer customers) or 1-888-788-4727 (Business customers).
- Write to us at Sprint Customer Service, P.O. Box 8077, London, KY 40742.

Automated Billing Information

For your convenience, your phone gives you access to billing information on your Sprint account. This information includes balance due, payment received, invoicing cycle, and the number of minutes used since your last invoicing cycle.

To access automated billing information:







- ▶ From the Phone screen, dial    .

Note: This service may not be available in all Affiliate areas.

Sprint 411

You have access to a variety of services and information through Sprint 411, including residential, business, and government listings; assistance with local or long-distance calls; movie listings; and hotel, restaurant, shopping, and major local event information. There is a per-call charge and you will be billed for airtime.



To call Sprint 411:

- ▶ From the Phone screen, dial      .

Sprint Operator Services

Sprint Operator Services provides assistance when placing collect calls or when placing calls billed to a local telephone calling card or third party.

To access Sprint Operator Services:

- ▶ From the Phone screen, dial  .

For more information or to see the latest in products and services, visit us online at www.sprint.com.

1.2 Your Device

Front Components

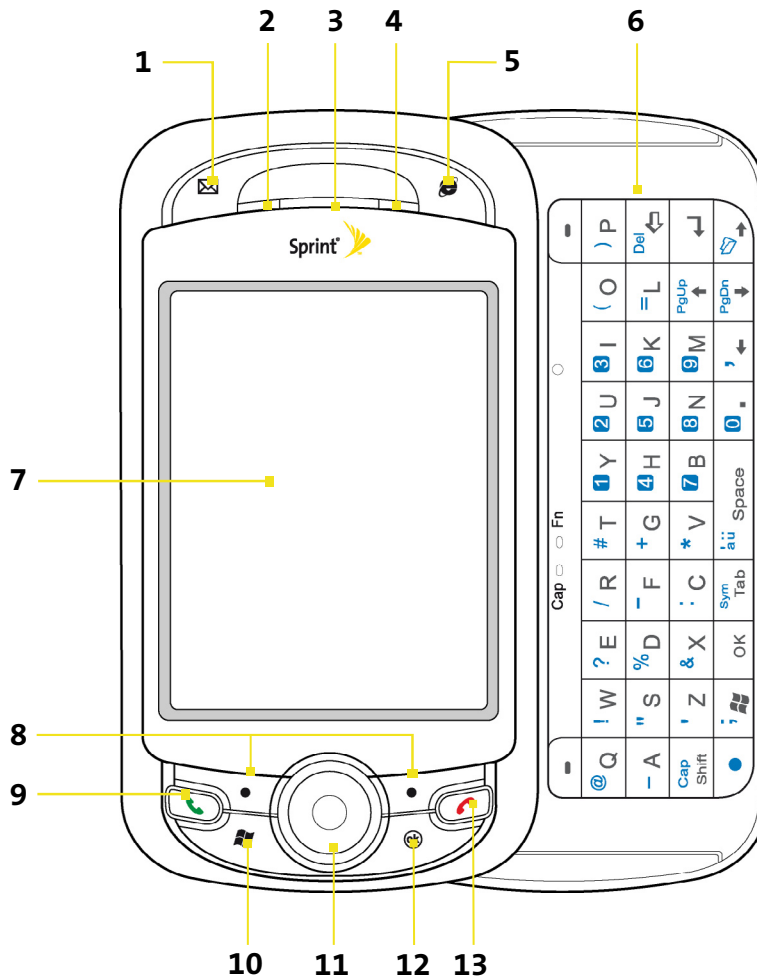

- 1. Messaging Key** Press to access your messages.
- 2. Notification LED 1** Bi-color LED on the left side: Blue and Green for Bluetooth status and availability, and Wi-Fi status. When both Bluetooth and Wi-Fi are enabled, blue and green lights blink alternately.
- 3. Earpiece** Listen to a phone call from here.
- 4. Notification LED 2** Bi-color LED on the right side: Green and Orange for CDMA standby, SMS message, CDMA network status, notification, battery charging status.
- 5. Web Key** Press to open Internet Explorer Mobile.
- 6. Hardware Keyboard** This is a QWERTY-style keyboard just like the computer keyboard. Slide the touch-screen panel to the left to reveal the keyboard. For more information, see "Using the Hardware Keyboard" in Section 2. Note: The protective film on the sliding keyboard can be removed.
- 7. Touch Screen** Tap the screen with the stylus to write, draw, or make a selection.
- 8. Left and Right Softkeys** Press to perform the command shown in the label above the button.
- 9. Talk Key** Press to answer an incoming call or dial a number.

- | | |
|--|--|
| 10. Start Key | Press to open the Start menu. |
| 11. NAVIGATION Control/
ENTER | Press this multi-directional control up, down, left, or right to move through menus and program instructions; carry out the selection by pressing ENTER (the center button). |
| 12. OK Key | Press to confirm your data entries, or to exit the program in use. |
| 13. End Key | Press to end a call or to return to the Today screen. |

Left, Back and Right Components

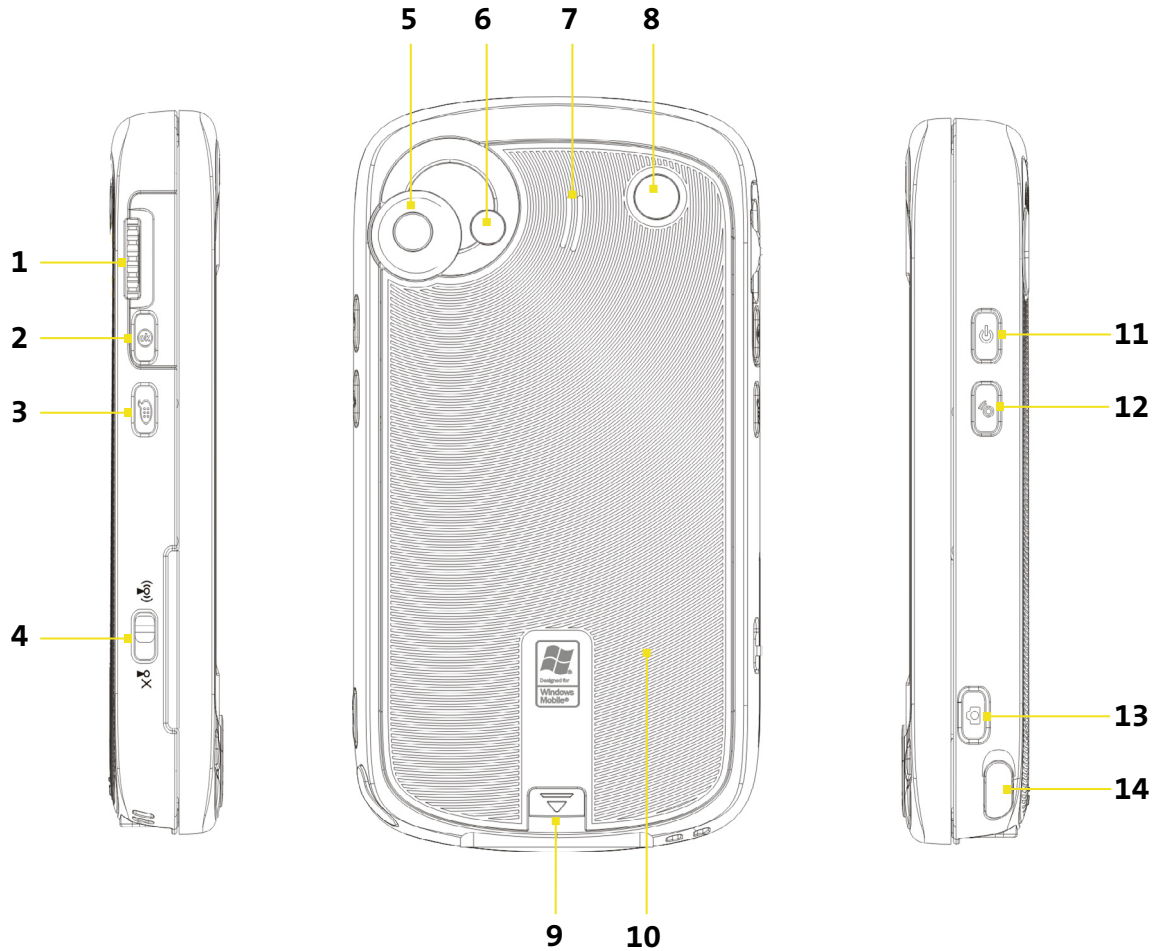

- | | |
|--|--|
| <p>1. Jog Wheel</p> <p>2. OK Key</p> <p>3. Voice Command Key</p> <p>4. WLAN Switch</p> <p>5. Camera</p> <p>6. Flash Light</p> <p>7. Speaker</p> <p>8. Car Antenna Connector</p> <p>9. Battery Cover Latch</p> <p>10. Battery Cover</p> | <p>While on the Today screen or using applications, scroll up or down to navigate through menus or program instructions; press the wheel to carry out a selection. During a call or while playing music, scroll up or down to adjust the sound volume.</p> <p>Press to confirm your data entries, or to exit the program in use.</p> <p>Press to start Voice Speed Dial; press and hold to record a voice note.</p> <p>Slide up to turn Wi-Fi on, down to turn Wi-Fi off.</p> <p>Use the camera to take still photos and record video clips.</p> <p>Allows you to capture images even in a dark environment. To turn on the flash, tap the Flash icon () when in Camera mode.</p> <p>Listen to media from here.</p> <p>Connect your device to an external antenna if you need better reception.</p> <p>Press downward to release the battery cover.</p> <p>After pressing down the cover latch, remove the battery cover to access the battery compartment.</p> |
|--|--|

- 11. Power Key**
 - Press and hold to turn on the power.
 - Press to turn off the display temporarily. This switches your device to Sleep mode. You can still receive calls and messages when your device is in Sleep mode.
 - Press and hold (for about five seconds) to turn off the power completely. All functions including the phone will be unavailable for use.
- 12. Comm Manager Key**

Press to open the Comm Manager. Comm Manager lets you easily turn on/off your device's connections (such as Bluetooth, Wi-Fi, and cellular data connection), ringer, phone, etc.
- 13. Camera Key**

Press and hold for two seconds to turn on the camera. Press again to take a picture.
- 14. Stylus and Stylus Slot**

Use the stylus to write, draw, or select items on the touch screen.

Bottom Components

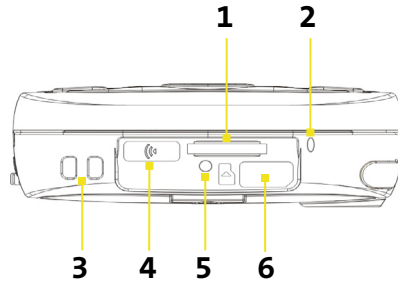

- | | | |
|----------|-------------------------------------|--|
| 1 | microSD Card Slot | Insert a microSD memory card for storing data. |
| 2 | Microphone | Speak into the microphone when receiving or making a phone call or when recording a voice note. |
| 3 | Strap Holder | Attach a strap for carrying your device. |
| 4 | Infrared Port | Exchange files or data with other devices wirelessly. |
| 5 | RESET Button | With the stylus, press the RESET button to soft-reset your device. |
| 6 | Sync Connector/Earphone Jack | Connect the supplied power adapter to charge the battery or the USB Sync cable to synchronize data with your PC. You can also plug in the provided splitter adapter to allow the power adapter and stereo headset to be connected to your device at the same time. |

Accessories

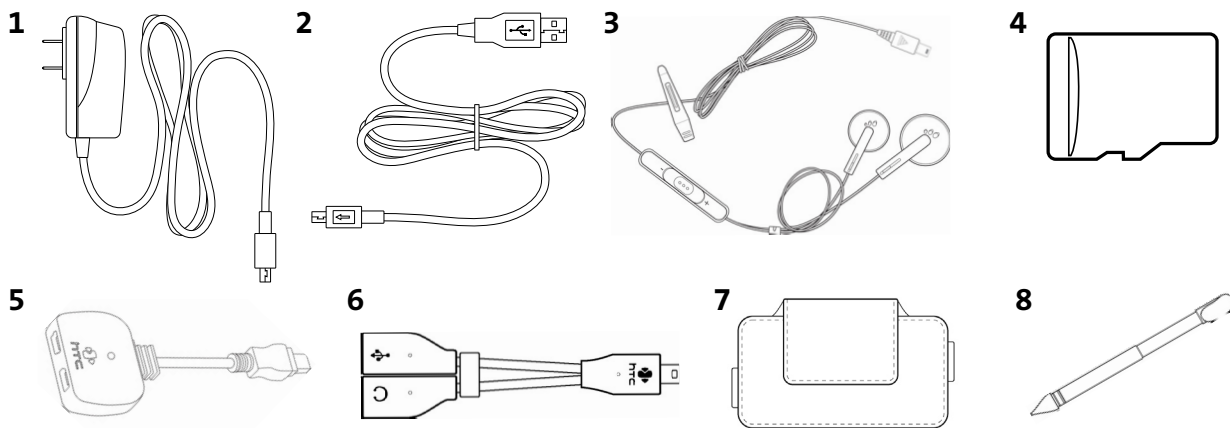

- | | |
|-----------------------------------|---|
| 1. AC Phone Charger | Recharges the battery. |
| 2. USB Sync Cable | Connects your device to a PC and synchronizes data. |
| 3. Mini-USB Stereo headset | Provides a volume control slider and a Send/End button. Press the Send/End button to pick up a call or put a call on hold; press and hold the button to end the call. |
| 4. microSD Card | The storage card is already installed in your device. |
| 5. Two Mini USB Adapter | Lets you connect the supplied AC phone charger and mini-USB stereo headset to your device at the same time. |
| 6. 2.5mm Headset Adapter | Lets you connect the supplied AC phone charger and a standard 2.5mm stereo headset to your device at the same time. |
| 7. Pouch | Comes with belt clip. Store your device in the pouch to keep it from dust and scratches. |
| 8. Stylus | An extra stylus pen is provided. |

Using Two Mini USB Adapter and 2.5mm Headset Adapter

To be able to charge the battery on your device using the AC phone charger, and at the same time, connect a wired stereo headset for hands-free phone conversation or for listening to audio media, you can use the splitter adapters that are supplied with your device.

To connect the AC phone charger and the supplied mini-USB stereo headset:

Use the two mini USB adapter for the connection.

1. Connect one end of the two mini USB adapter to the Sync connector at the bottom of your device.
2. Connect the supplied mini-USB stereo headset to the Audio connector of the two mini USB adapter.
3. Connect the AC phone charger to the Power connector of the two mini USB adapter.

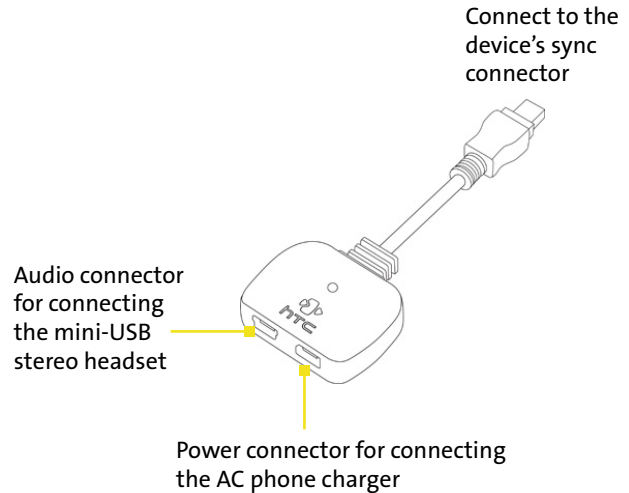

To connect the AC phone charger and a standard 2.5mm stereo headset:

Use the 2.5mm headset adapter for the connection.

1. Connect one end of the 2.5mm headset adapter to the sync connector at the bottom of your device.
2. Connect a standard 2.5mm stereo headset to the audio jack of the 2.5mm headset adapter.
3. Connect the AC phone charger to the power connector (5-pin) of the 2.5mm headset adapter.

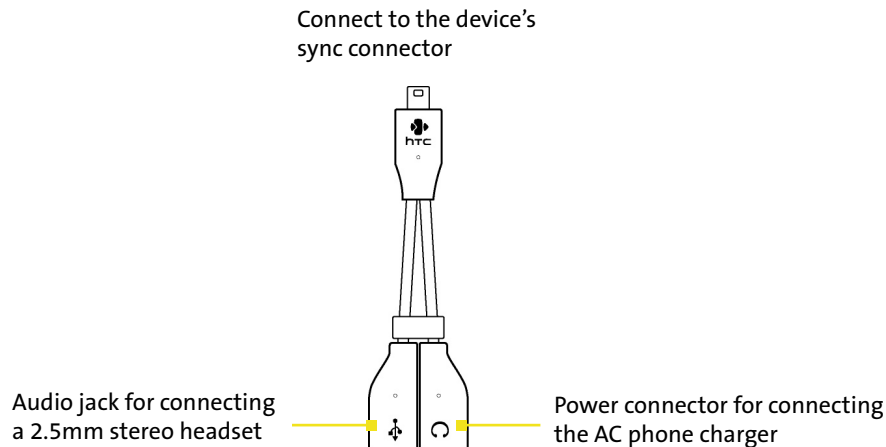

1.3 Battery Information

Your device comes with a rechargeable Li-Ion polymer battery. Use only manufacturer-specified original batteries and accessories with your device. Battery performance depends on many factors, including network configuration, signal strength, the temperature of the environment in which you operate your device, the features and/or settings you select and use, items attached to your device's connecting ports, and your voice, data, and other program usage patterns.



Warning: To reduce risk of fire or burns, do not disassemble, crush, puncture, short external contacts, heat above 60°C (140°F), or dispose of in fire or water. Replace only with manufacturer specified batteries. Recycle or dispose of used batteries according to the local regulations.



Installing and Charging the Battery

New batteries are shipped partially charged. Before you start using your device, you need to install and charge the battery.

To install the battery:

1. Press the battery cover latch downward to release the battery cover.

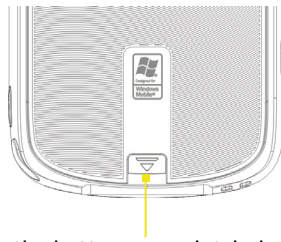

Press the battery cover latch downward and then remove the battery cover.

2. Remove the battery cover.
3. Insert the battery by aligning the exposed copper part of the battery pack with the protruding copper conductor located on the upper end of the battery compartment. Insert the upper side of the battery first, and then gently push the battery into place.

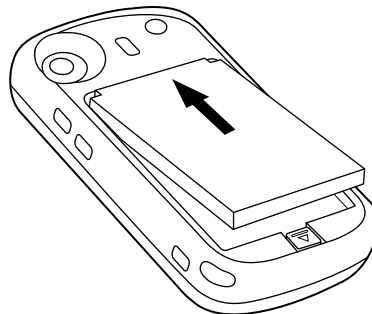

4. Replace the battery cover.

To charge the battery:

Some batteries perform best after several full charge/discharge cycles. The time needed to fully charge the battery is less than 4 hours. You can charge the battery in one of the following ways:

- Connect your device directly to an electrical outlet using the AC phone charger.
- Plug the sync cable to the USB port on your PC and to the sync connector on your device.

Note:

Do not remove the battery from the device while you are charging it using the AC phone charger. As a safety precaution, the battery stops charging when it overheats.

Low Battery

When the low-battery warning appears, do the following:

- Immediately save your current data.
- Immediately charge the battery by using the AC phone charger.
- Synchronize with your PC (see Section 5).
- Turn off your device.

To check the battery power:

- ▶ Tap the **Battery** icon on the Today screen;
— or —
- ▶ Tap **Start > Settings > System tab > Power**.

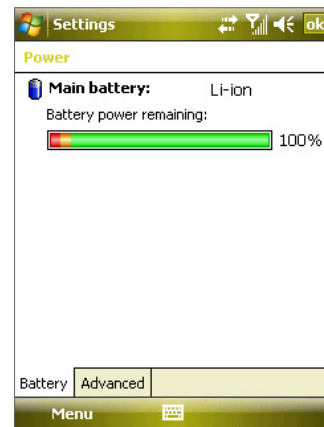

Power information

1.4 Starting Up

Turning Your Device On and Off

To turn on your device, press and hold the **Power** Key at the right side of the device. When you turn on your device for the first time, a Quick Start Wizard will guide you through the calibration process and the setup of regional settings, date and time, and password. For more information about touch screen calibration, see “Calibrating the Device.” For information about setting up the device password, see “Protecting Your Device” in Section 4.

To turn off your device, press and hold the **Power** Key for a few seconds. A message will then be displayed, prompting you whether to turn off the device completely.

Switching to Sleep Mode

Quickly pressing the **Power** Key turns off the display temporarily and switches your device to **sleep mode**. Sleep mode suspends your device to a low power state while the display is off in order to save battery power.

Your device also automatically goes into sleep mode when you leave the device idle after a certain amount of time.

To specify the timeout period before your device goes into sleep mode:

1. Tap **Start > Settings > System tab > Power > Advanced** tab.
2. Under **On battery power**, make sure the **Turn off device if not used for** check box is selected.
3. Select the battery timeout period, and then tap **OK**.

You will still be able to receive messages and calls while your device is in sleep mode. Pressing the **Power** Key again or new incoming calls/messages will wake up your device.

Calibrating the Device

Calibrating the device screen involves tapping the center of a cross with the stylus as it moves around the screen. This process ensures that when you tap the screen with your stylus, the tapped item is activated.

If your device does not accurately respond to screen taps, please follow these steps to recalibrate it:

1. Tap **Start > Settings > System tab > Screen**.
2. On the **General** tab, tap **Align Screen**, and follow the instructions on the screen.

Key Lock

It is possible to lock the buttons on the device, so that the applications may not be accidentally launched. Once you enable this feature, only the **Power** Key can turn on your device.

To lock buttons:

- ▶ Tap  on the Today screen.

To unlock buttons:

- ▶ Tap **Unlock** or press the left softkey. Then, tap **Unlock** again.

Note:

To change the Key Lock settings, tap **Start > Settings > System tab > Key Lock**.

The Key Lock feature does not disable the phone function of your device. When you enable this feature, you still can use the buttons on the device to receive or reject an incoming call.

Managing Screen Settings

The device touch screen has three orientation modes: Portrait, Landscape (right-handed), and Landscape (left-handed). Portrait mode allows you to get a better view or a better operation of certain programs on your device, while Landscape mode may be optimal for viewing longer document files.

- To change the orientation, tap **Start > Settings > System tab > Screen**, and select the orientation you want: **Portrait**, **Landscape (right-handed)**, or **Landscape (left-handed)**.
- To smooth the edges of screen fonts for many programs, on the **ClearType** tab, select the **Enable ClearType** check box.
- To increase the readability or to see more content on the screen, on the **Text Size** tab, adjust the text size by moving the slider.

1.5 The Today Screen

The Today screen displays important information, such as upcoming appointments and status indicators. You can tap a section on the screen to open the associated program.

- To access the Today screen, tap **Start > Today**.
- To customize the Today screen display, including the background image, tap **Start > Settings > Personal tab > Today**.









































- 1 Tap to open the Start menu.
- 2 Tap to view call status information.
- 3 Tap to view network status and related options.
- 4 Tap to adjust device volume level.
- 5 Displays the current time. Tap to check the current date and upcoming appointments. Tap and hold to change the clock mode to Analog or Digital.
- 6 Open Quick Menu (see “Quick Menu” in this section for details).
- 7 Displays the current date. Tap to set up date, time, alarm, and more.
- 8 **Getting Started** provides a list of “how to's” that you can reference to learn basic features and settings of your device.
- 9 Tap to set owner information.
- 10 Tap to access your voicemail.
- 11 Indicates the incoming messages. Tap to open **Messaging**.
- 12 Tap to lock the device. The icon changes to . Tap **Unlock** on the Today screen to unlock again.
- 13 Reminds you of the appointment(s). Tap to open **Calendar**.
- 14 Displays the task(s) that you need to do. Tap to open **Tasks**.
- 15 **Live Search** allows you to quickly and efficiently search the Web through Internet Explorer.
- 16 Tap to launch **Sprint Navigation**.
- 17 Tap to connect to Sprint Music Store.
- 18 **System icons**:
 - Indicate the battery status. Tap to open the Power Settings screen.
 - Tap to toggle the display portrait and landscape modes.
 - Tap to open Comm Manager.
 - Tap to open the Backlight Settings screen.
- 19 Tap to open **Calendar**.
- 20 Tap to open **Contacts**.

Note:

You can access the Today screen from anywhere by tapping **Start > Today**.

Indicators

The following are some of the status icons that you may see on your device.

Icon	Description
	New email or text messages
	New voicemail
	New MSN message
	There are more notifications. Tap the icon to view all.
	Speakerphone on
	Voice call in progress
	Missed call
	Maximum signal strength
	No signal
	Phone is turned off
	No phone service
	Searching for phone service
	1xRTT available
	EVDO available
	Data connection is active and transmitting data
	Data connection is active but idle
	Roaming
	Connection is active
	Connection is not active
	Synchronization in progress
	Synchronization error
	ActiveSync notification
	Wi-Fi function enabled, but device not connected to a wireless network yet
	Wireless network(s) detected
	Connecting to wireless network (arrows moving); Connected to wireless network
	Synchronizing via Wi-Fi
	Vibration mode
	Sound on
	Sound off
	Alarm
	Battery is fully charged
	Battery power is very low
	Battery charging
	Device is locked / unlocked
	Portrait display mode
	Landscape display mode
	Bluetooth headset detected
	Serial USB connection active

Note:

The USB to PC () icon appears on the Today Screen when you enable a serial USB connection between your device and computer.

The Start Menu

The **Start** menu, located at the top left corner of the Today screen, displays a list of programs. It lets you close a screen and switch from one program to another. You can start a program by scrolling through the programs list and then pressing **ENTER**, or by tapping a program with the stylus.

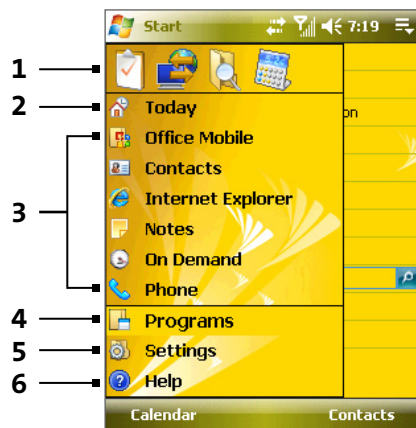

- 1 Open a recently used program.
- 2 Switch to the Today screen.
- 3 Open a program. (The items displayed in the Start menu can be customized by tapping **Start > Settings > Personal tab > Menus**.)
- 4 Access more programs.
- 5 View and change settings.
- 6 View Help information for the current screen.

The Quick Menu

The **Quick Menu**, located at the top right corner of the Today screen, shows the currently running programs. You can quickly switch between running programs and stop programs when you do not need to use them.

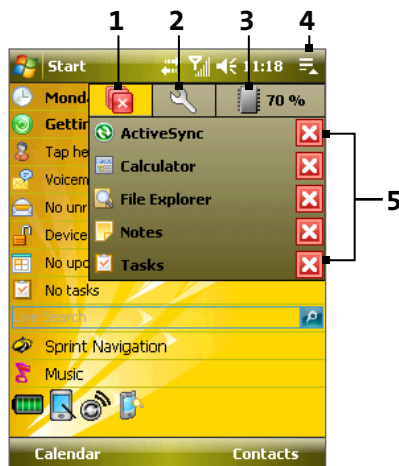











- 1 Stop all currently running programs.
- 2 Customize Task Manager settings. (See “Using Task Manager” in Section 13.)
- 3 Display the percentage of memory in use. Tap this icon to view more information about memory usage.
- 4 Tap this button to open the Quick Menu.
- 5
 - To switch to a running program, tap the program name.
 - To stop running a program, tap .













1.6 Programs















The following are some of the icons for the programs that are already installed on your device.

Programs in the Start Menu

Icon	Description
	Office Mobile Use the complete suite of Microsoft® Office applications for your mobile device.  Excel Mobile Create new workbooks or view and edit Microsoft® Office Excel® workbooks.  OneNote Mobile Create notes with text, photos, and voice recordings.  PowerPoint Mobile View Microsoft® Office PowerPoint® slides and presentations.  Word Mobile Create, view, and edit Microsoft® Office Word documents.
	Contacts Keep track of your friends and colleagues.
	Internet Explorer Mobile Browse Web and WAP sites as well as download new programs and files from the Internet.
	Notes Create handwritten or typed notes, drawings, and voice recordings.
	On Demand Provide personalized content service (news, sports, weather, etc.) on your device.
	Phone Make and receive calls, switch between calls, and set up conference calling.
	Help See Help topics for the current screen or program.

Programs screen











Icon	Description
	Games Play two pre-installed games: Bubble Breaker and Solitaire .
	ActiveSync Synchronize information between your device and a PC or the Exchange Server.
	Adobe Reader LE View PDF (Portable Document Format) files on your device.
	AudiblePlayer Listen to the audiobooks, magazines, newspaper, and radio programs on your device.
	Calculator Perform basic arithmetic and calculations, such as addition, subtraction, multiplication, and division.
	Calendar Keep track of your appointments and create meeting requests.
	Camera Take photos or shoot video clips with accompanying audio.
	File Explorer Organize and manage files on your device.
	GetGood Launch the Web browser and connect to GoodLink to get the stuff you want.
	Getting Started View a list of “how to’s” that you can reference to learn basic features and settings of your device.
	Internet Sharing Connect your computer to the Internet using your device’s data connection.
	Java Download and install Java applications, such as games and tools, on your device.

Icon	Description
	Messaging Send and receive email and text messages
	Messenger Use this mobile version of Windows Live Messenger to send and receive instant messages on your device
	Pictures & Videos View, organize, and sort pictures, animated GIFs, and video files on your device or a storage card.
	Search Search contacts, data, and other information on your device.
	Software Store Launch the Web browser and connect to Sprint Mobile Software Store automatically.
	Sprint Music Go online to access the Sprint Music Store and download your favorite music.
	Sprint Navigation Turn your phone to a navigation device.
	Sprint TV Watch your favorite TV shows on the device.
	Tasks Keep track of your tasks.
	Voice Speed Dial Record voice tags so that you can dial a phone number or launch programs simply by speaking a word.
	Voice SpeedDial Switch Enable or disable Voice Speed Dial to be launched when the Voice Command Key is pressed.
	Windows Live Use this mobile version of Windows Live™ to find information on the Web. It also lets you sign into your Windows Live account so that you can access your Live Mail messages and send/receive instant messages in Live Messenger.
	Windows Media Player Mobile Play back audio and video files.
	ZIP Save memory and free up storage space on your device by compressing files in the conventional ZIP format.









1.7 Settings













You can adjust the device settings to suit the way you work. To see all available settings, tap **Start > Settings**, and then tap the **Personal**, **System**, and **Connections** tabs located at the bottom of the screen.

Personal Tab









Icon	Description
	Buttons assigns a program to a hardware button.
	Input sets options for each of the input methods.
	Large Start Menu enlarge the Start menu to make it easier to touch menu items with your fingers.
	Lock sets a password for your device.
	Menus sets what programs will appear in the Start menu.
	Owner Information allows you to enter your personal information on your device.
	Phone allows you to customize phone settings such as ring tone, optional phone services, and more.
	Sliding Sound allows you to select a slide-in and slide-out sound for the hardware keyboard.
	Sounds & Notifications enables sounds for events, notifications, and more, and allows you to set the type of notification for different events.
	Today allows you to customize the appearance and the information to be displayed on the Today screen.
	Voice Speed Dial allows you to create voice tags for voice dialing contacts as well as for launching programs.

System Tab

Icon	Description
	About allows you to specify a name for your device. Also shows the Windows Mobile version and copyright information.
	Backlight sets the backlight timeout and brightness.
	Certificates shows information about certificates that are installed on your device.
	Clear Storage removes all your data and files from the memory and resets your device to factory default settings.
	Clock & Alarms switches the device clock to the date and time of your locale or to a visiting time zone when you're traveling. Alarms can also be set at specified days and times of a week.
	Customer Feedback allows you to send feedback to the Customer Experience Improvement Program of Microsoft.
	Device Information shows information about the firmware version, hardware, identity, and the duration of calls made on your device.
	Encryption allows files on your storage card to be encrypted. Encrypted files will be readable only on your device.

Icon	Description
	Error Reporting enables or disables the device's error reporting function. When this function is enabled and a program error occurs, technical data about the state of the program and your computer will be logged in a text file and delivered to Microsoft's technical support if you choose to send it.
	External GPS sets the appropriate GPS communication ports, if required. You may need to do this when there are programs on your device that access GPS data or you have connected a GPS receiver to your device. See Help for details.
	Key Lock locks the buttons on your device except for the Power Key when the device is in sleep mode. This ensures you will not switch the device on by accident and consume unnecessary power.
	Managed Programs downloads and installs applications that are deployed by the System Center Mobile Device Manager. This program also lets you view applications which were installed from the System Center Mobile Device Manager.
	Memory shows the device memory allocation status and memory card information. Also allows you to stop currently running programs.
	Power shows the current battery level. Also allows you to set the timeout for turning off the display (switching device to sleep mode) to conserve battery power.
	Regional Settings sets the regional format to use for displaying numbers, currency, date, and time on your device.
	Remove Programs allows you to remove programs that you installed on your device.
	Screen allows you to change the screen orientation, recalibrate the screen, and change the screen text size.
	Task Manager stops running programs and set the Exit button () to end programs immediately when you tap the button. For more information, see "Using Task Manager" in Section 13.
	Windows Update links to Microsoft's Web site and update Windows Mobile on your device with the latest security patches or fixes.

Connections Tab

Icon	Description
	Beam enables your device to receive incoming infrared and Bluetooth beams.
	Bluetooth turns Bluetooth on, sets your device to visible mode, and allows you to scan for other Bluetooth devices.
	Comm Manager allows you to manage the device's connections (including Bluetooth, Wi-Fi, and cellular data connection), turn the phone function on or off, change to ringer or vibration mode, and more.
	Connections sets up one or more types of modem connections for your device, such as phone dial-up, Bluetooth, and more, so that your device can connect to the Internet or a private local network.
	Domain Enroll enrolls your device with your company's domain to access company resources.
	USB to PC sets the USB connection between your device and PC, and helps with problems connecting ActiveSync.
	Wi-Fi allows your device to scan for available wireless networks.
	Wireless LAN shows information about the active wireless network, and allows you to customize Wi-Fi settings.

Section 2

Entering and Searching Information

In This Section

2.1 Using the Hardware Keyboard

2.2 Entering Information

2.3 Using the Onscreen Keyboard

2.4 Using Letter Recognizer

2.5 Using Block Recognizer

2.6 Using Transcriber

2.7 Using Symbol Pad

2.8 Using Notes to Draw, Write, and Record Voice Notes

2.9 Searching Information







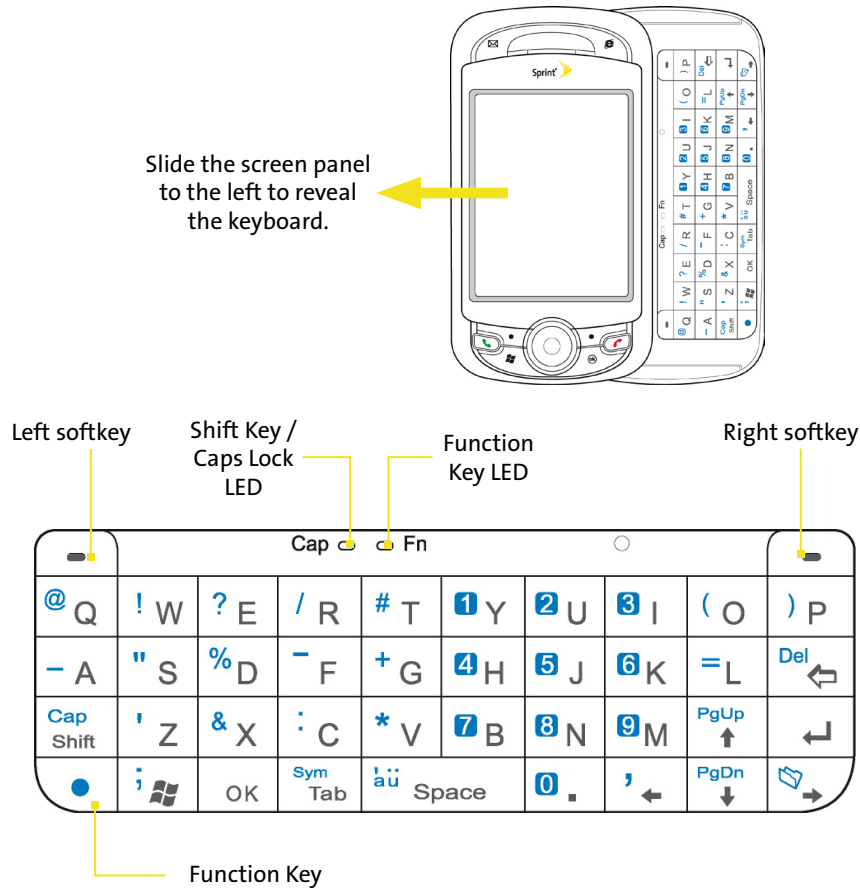











2.1 Using the Hardware Keyboard

Your device provides you with a QWERTY keyboard, which is similar to a standard computer keyboard.



When you slide open the hardware keyboard, the screen automatically changes to landscape view. The screen changes back to portrait view when you close the hardware keyboard.

You can do the following with the QWERTY keyboard:

- To type lowercase letters, press the keys using your thumbs or fingers.
- To turn on Caps Lock mode so that you can type all uppercase letters, press the Function Key () first, and then press  . The Shift Key/Caps Lock LED lights up to indicate that Caps Lock mode is enabled. To turn off Caps Lock mode, press these buttons again.
- To type a single uppercase letter, press  and then press the desired letter.
- To enter a number or symbol (labeled in color on the keys), press  and then press the corresponding key.
- To open the Symbol Pad, press  and then press  .
- Press the left or right softkeys ( / ) to perform the command shown in the label above the keys.
- Press  to verify your data entries or exit the program in use.
- Press  to open the Start menu.
- Press the arrow keys     for directional movement.
- To type accented characters (like á, ã, ç, ê, í, ó, ü, etc), press the letter key first, and then hold  at the same time pressing the space bar  several times until you find the character you need.





2.2 Entering Information

When you start a program or select a field that requires text or numbers, the **Input Panel** icon becomes available on the menu bar.

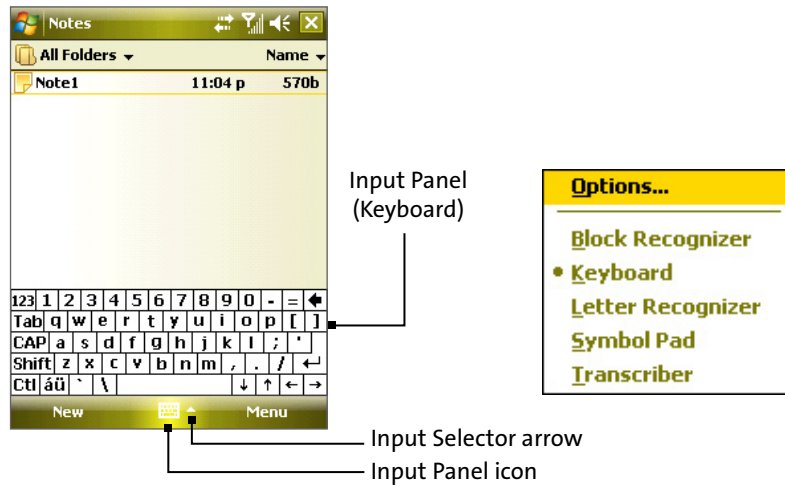
Tap the **Input Selector** arrow (which appears next to the **Input Panel** icon) to open a menu where you can select a text input method and customize input options. After selecting a text input method, the corresponding **Input Panel** is then displayed and you can use it to enter text. To toggle between showing and hiding the **Input Panel**, simply tap the **Input Panel** icon.

Example:



Icon	Input method
	Onscreen Keyboard
	Letter Recognizer or Block Recognizer
	Symbol Pad
	Transcriber

2.3 Using the Onscreen Keyboard

The onscreen keyboard is available when text entry is possible. You can enter text by tapping keys on the keyboard that are displayed on the screen.

To enter text using the onscreen keyboard:

1. In a program, tap the **Input Selector** arrow, and then tap **Keyboard**.
2. Enter text by tapping keys on the onscreen keyboard.

To enlarge the onscreen keyboard:

1. Tap the **Input Selector** arrow, and then tap **Options**.
2. In the **Input method** list, select **Keyboard**.
3. Tap **Large Keys**.

2.4 Using Letter Recognizer

With **Letter Recognizer**, you can write individual letters, numbers, and punctuation, which are then converted into typed text.

To use Letter Recognizer:

1. In a program, tap the **Input Selector** arrow, and then tap **Letter Recognizer**.
2. Write characters, numbers, and symbols in the designated writing area.
 - Enter capital letters by writing in the **ABC** (left) area of the box.
 - Enter lower case letters by writing in the **abc** (middle) area of the box.
 - Enter numbers by writing in the **123** (right) area of the box.
 - Enter punctuation and symbols by tapping in either area of the box and then writing the desired character.

Note: **Letter Recognizer** is available when text entry is possible.

Tip: For help with writing characters with **Letter Recognizer**, tap the question mark near the writing area.

2.5 Using Block Recognizer

With **Block Recognizer**, you use a single stroke to write letters, numbers, symbols, and punctuation, which are then converted into typed text.

To use Block Recognizer:

1. In a program, tap the **Input Selector** arrow, and then tap **Block Recognizer**.
2. Write characters, numbers, and symbols in the designated writing area.
 - Enter letters by writing in the **abc** (left) area of the box.
 - Enter numbers by writing in the **123** (right) area of the box.
 - Enter symbols and punctuation by tapping in either area of the box, and then writing the desired character.

Note:	Block Recognizer is available when text entry is possible.
--------------	---

Tip:	For help with writing characters with Block Recognizer , tap the question mark near the writing area.
-------------	--

2.6 Using Transcriber

Transcriber is a handwriting recognition program that allows you to write in cursive or printed (block) letters or a combination of both. Transcriber works transparently in the background of programs, recognizing words with its integrated dictionary. When Transcriber is turned on, it interprets stylus movement anywhere on the screen as handwriting input. For more information about using Transcriber, see Help on your device.

To start Transcriber:

1. Start a program that accepts user input, such as Word Mobile.
2. Tap the **Input Selector** arrow, and then tap **Transcriber**. The Transcriber introductory screen appears.

To write using Transcriber:

1. From the Transcriber Info screen, tap **OK** to display your program's entry screen.
2. Use your stylus to write cursive or printed text. Transcriber will wait until you pause and then convert your entry into typed text.

To enter punctuation and symbols:

Transcriber comes with an onscreen keyboard that provides an easy way to add punctuation or a special symbol to existing text.

- ▶ In a program, tap  on the Transcriber toolbar. The keyboard remains visible until you tap the button again.

Tips:

To reposition the keyboard, tap and hold the title bar, and then drag to the desired location.

When no text is selected, you can also open the keyboard by doing the  gesture. For more information about using Transcriber gestures, see Help on your device.

To edit text:

1. In a program, draw a line across the text you want to edit.
2. After you lift the stylus from the screen, the line will disappear and the selected text will be highlighted.
3. Do either of the following:
 - Rewrite the text.
 - Use gestures to capitalize letters, insert a space, and so on. For information about using gestures, see Help on your device.

2.7 Using Symbol Pad

Symbol Pad provides a comprehensive list of common symbols such as parentheses, brackets, currency signs, and more, as well as punctuation marks and special characters.

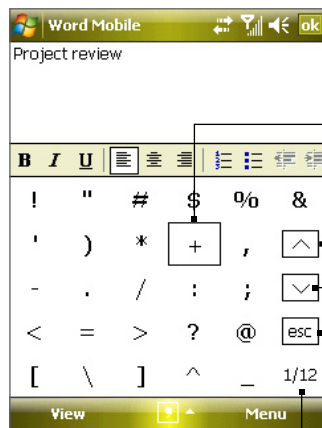

Tap a symbol to select it. Use the Navigation Control or press the arrow keys  on the hardware keyboard to navigate through the available symbols, and then press ENTER to select a symbol.

Tap to display the previous page of symbols.

Tap to display the next page of symbols.



Tap to close Symbol Pad without selecting any symbol.



This indicates the current page and the total number of symbol pages.

To open Symbol Pad and select a symbol:

1. Create or open a document, such as a Word document.
2. Tap the **Input Selector** arrow, and then tap **Symbol Pad**.

— or —

Using the hardware keyboard, press  and then press .

3. Tap  /  on the Symbol Pad screen to browse through the pages of symbols.
4. Tap a symbol to select it and close the Symbol Pad. The selected symbol will then be inserted in your document.

2.8 Using Notes to Draw, Write, and Record Voice Notes

Using **Notes**, you can draw directly on the screen, or write on the screen and save notes in your own handwriting. You can also create a stand-alone recording (voice note) or you can add a recording to a note.

For more information on what you can do with Notes, see “Notes” in Section 7.



2.9 Searching Information

You can search for files and other items stored in the My Documents folder of your device, or on a storage card that is installed in the device. You can search by file name or by words located in the item. For example, you can search in email messages, notes, appointments, contacts, and tasks, as well as in online Help.

To search for a file or an item:

1. Tap **Start > Programs > Search**.
2. In **Search for**, enter the file name, word, or other information you want to search for.
3. If you have looked for this item before, tap the **Search for** arrow and select the item from the list.
4. In **Type**, select a data type to help narrow your search.
5. Tap **Search**.
6. The My Documents folder and subfolders are searched.
7. In the **Results** list, tap the item you want to open.

Note:

The storage card symbol ( or ) is displayed next to the names of files saved on a storage card.

Section 3

Using Phone Features

In This Section

- 3.1 Using the Phone
 - 3.2 Making a Call
 - 3.3 Receiving a Call
 - 3.4 Smart Dialing
 - 3.5 In-Call Options
 - 3.6 In-Call Options
 - 3.7 Additional Dialing Information
 - 3.8 Phone Settings
 - 3.9 Setting Additional Service Options
 - 3.10 Voice and Data Roaming
 - 3.11 Customizing Plus Code Dialing
-



3.1 Using the Phone

Like a standard wireless phone, you can use your device to make, receive, and keep track of calls and send SMS messages. You can also take notes while talking and dial directly from Contacts.

The Phone Screen

From the Phone screen, you can access Call History, Speed Dial, and Phone settings. To open the Phone screen, do one of the following:

- Use the stylus and tap **Start > Phone**;
— or —
- Press the **Talk Key** on the device;
— or —
- Directly dial a phone number by pressing numeric keys on the hardware keyboard.

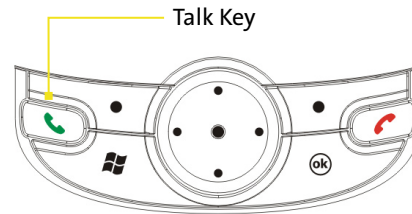

To turn the phone function on or off:

In many countries, you are required by law to turn off the phone onboard aircraft. Turning off the display switches your device to sleep mode but doesn't turn off the phone. You can disable the phone function temporarily and still keep your device turned on and use other functions.

1. Tap the **Signal icon** (), and then tap **Comm Manager**.



— or —

Tap the **Comm Manager icon** () on the Today screen.

2. On the Comm Manager screen, tap the **Phone** button  to turn the phone off.

To resume call function, tap the **Phone** button again  on the Comm Manager screen.

To adjust the device volume:

1. Tap the **Speaker icon** ().
2. Under Volume, do the following:
 - Adjust the phone volume () or device volume () by moving the slider to the desired volume level.
 - Tap **On**, **Vibrate**, or **Off** to change both the system and ringer volume settings.

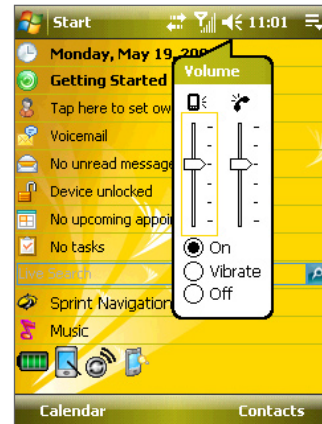

Adjusting volume

Notes:

To adjust the conversation phone volume, you must do it during a call. Adjusting the volume at another time will affect the ring, notification, and MP3 sound levels.

When you enable vibrate mode, sound will automatically be muted and the device will vibrate when an incoming call is received. The **Vibrate** icon () will appear in the title bar to indicate that vibrate mode is enabled.

3.2 Making a Call

With your device, you can make a call from Phone, Contacts, Call History, and Speed Dial.

Making a Call From the Phone Screen

On the Phone screen, tap the desired phone number, and tap **Talk** at the lower right of the screen. If you tap a wrong number, tap the back arrow () to erase individual numbers one at a time. To delete all the numbers, tap and hold the back arrow.

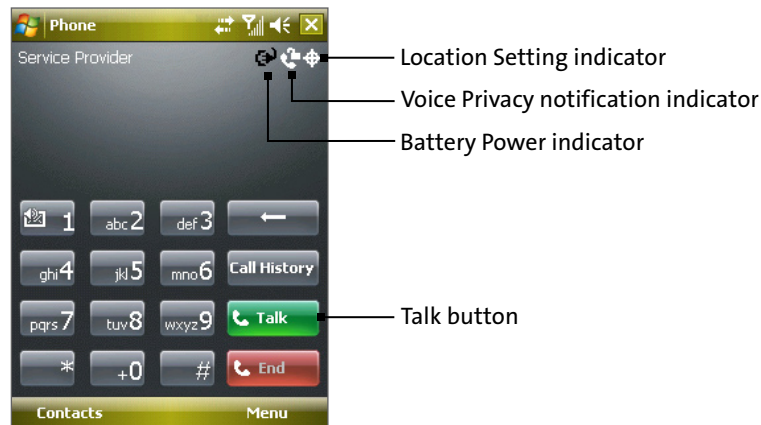

Phone screen

Note:

The icons on the upper right of the Phone screen indicate the battery power level and optional phone services. See “Setting Additional Service Options” later in this Section for more information.

Making a Call From Contacts

Tap **Contacts** on the Today screen and then do one of the following:

- Tap the desired contact in the Contacts list, and tap the phone number that you want to call.
- Tap the desired contact, and press the **Talk Key** twice (once to send the number to the Phone screen, and once to dial the number).
- Tap and hold the desired contact, and on the shortcut menu, tap **Call Work**, **Call Home**, or **Call Mobile**.

To dial one of the phone numbers of a contact:

By default, the wireless telephone number for a contact is dialed when you make a call from Contacts. However, you can specify that a different phone number is dialed instead.

1. Tap **Contacts** on the Today screen.
2. Press the Navigation Control up or down to select the contact.
3. Press the Navigation Control left or right. The letters representing the number will change as you scroll through them.

Making a Call From Call History

1. On the Phone screen, tap **Call History**.
2. Tap **Menu > Filter** and tap a category.
3. Scroll to the desired contact or phone number, and tap **Call**.

Making a Call From Speed Dial

Use **Speed Dial** to call frequently used numbers with a single tap. For example, if you assign a contact to Location 2 in Speed Dial, you can simply tap and hold **2** on the Phone screen to dial the contact's number. The number must already exist in Contacts before you can create a speed dial entry. When creating a speed dial, note that Location 1 is generally reserved for your voicemail.

To create a speed dial entry:

1. On the Phone screen, tap **Menu > Speed Dial**.
2. Tap **Menu > New**.
3. Tap a contact. Tap the phone number for which you want to create a speed dial.
4. In the **Location** box, select an available location for the new speed dial.

Tips:

To create a speed dial entry from Contacts, tap and hold the contact name, tap **Add to Speed Dial**, and then select an available location for the new Speed Dial.

To delete a speed dial, in the **Speed Dial** list, tap and hold the desired entry, and then tap **Delete**.

3.3 Receiving a Call

To answer or reject an incoming call:

When you receive a phone call, a message will appear, giving you an option to either answer or ignore the incoming call.

- ▶ To answer the call, tap **Answer**, or press the **Talk Key**.
- ▶ To reject the call, tap **Ignore**, or press the **End Key**.

To end a call:

- ▶ Once an incoming or outgoing call is in progress, you can tap **End**, or press the **End Key** to hang up.

3.4 Smart Dialing

Smart Dialing is a program that makes it easy for you to dial a phone number. When you start entering numbers or characters, Smart Dialing will automatically search and sort the contact entries in Contacts and the phone numbers in Call History (including incoming, outgoing, and missed calls). You can then select the desired number or contact from the filtered list to dial.

Starting Smart Dialing

Open the Phone screen, and then tap the keys on the Phone keypad that correspond to the phone number or contact you want to call.

When you start entering a number or letter, the Smart Dialing panel will appear automatically on the Phone screen. You can change the panel size according to your needs by tapping the arrow icon .



Tips on Using Smart Dialing

Smart Dialing starts looking for numbers or contacts that match the sequence you have entered. Below are some tips on how to use Smart Dialing to quickly find a desired phone number or contact.

To find a phone number:

- ▶ Simply enter the first one or two digits to find a phone number in Call History.
- ▶ Enter the first three digits or more if you want to find a phone number from the saved contacts on your device.

To find a contact name:

You can just enter the first letter of a contact's first name or surname. Smart Dialing will search for the letter starting from the first character of a contact name as well as from the character that appears after a space, dash, or underscore in a contact name. For example, if you tap number "2" which is associated with [a, b, c] on the Phone keypad, contact names such as the following will be considered matches: "Ben Miller," "George Adams," "John-Carter," "Carter, Ellen," "Dixon, Allan," "Thomas_Clark," "JaneCampbell."

If the matching list is long and you want to narrow down the search further, enter another letter. Using the same example above, if you continue to tap "3" which is associated with [d, e, f], the matching list will be narrowed down to the following names: "Ben Miller," "George Adams," "Carter, Ellen," "Dixon, Allan."

Making a Call or Sending a Text Message Using Smart Dialing

1. Begin entering the first few numbers or characters.
2. In the Smart Dialing panel, browse the list by tapping the arrows (⬆️ / ⬇️), pressing the Navigation Control up or down, or rolling the Jog Wheel to select the desired contact or phone number. When a contact is selected, it expands to also show the corresponding phone number.
3. The highlighted item will move one line when you press the Navigation Control up or down or roll the Jog Wheel; the highlighted item will scroll one page when you tap the arrows.
4. Do one of the following:
 - When the correct contact is selected, tap **Talk** or press the **Talk Key** (📞) to make a voice call.
 - To call a different phone number associated with the selected contact, tap and hold the selected contact, and tap the phone number you want to call.



Tap and hold the contact to pop up the shortcut menu

- To send a text message to the selected contact, tap and hold the contact, and tap **Send Text Message**.

Tip:

To view or edit information associated with the selected contact, tap the contact's name on the shortcut menu.



Setting Up Smart Dialing

1. On the Phone screen, tap **Menu > Smart Dialing Options**.
2. On the **Options** tab, select the **Enable Smart Dialing** check box.
 - Select the **Automatically expand selected contact** check box to enable a contact's name and phone number to be displayed when the contact is selected in the matching list.
 - Select the **Enable drag-scroll** check box to scroll in the matched list by dragging.
 - Select the **Enable double-click for dialing** check box to make a voice call by double-tapping the item in the matched list.
 - Select the **Expand panel when using hardware keyboard** check box to automatically expand the Smart Dialing panel when you are using the sliding keyboard to input.
 - In **Scroll unit**, you can set the amount of scrolling when tapping the arrows (⬆️ / ⬇️).





3.5 Using Call Forwarding

Call Forwarding lets you forward all your incoming calls to another phone number – even when your phone is turned off. You can continue to make calls from your phone when Call Forwarding is activated.

To activate Call Forwarding:

1. From the Phone screen, tap   .
2. Enter the area code and phone number to which your future calls should be forwarded.
3. Press the **Talk Key**. (You will see a message and hear a tone to confirm the activation of Call Forwarding.)

To deactivate Call Forwarding:

1. From the Phone screen, tap    .
2. Press the **Talk Key**. (You will see a message and hear a tone to confirm the deactivation.)

Note:

You are charged a higher rate for calls you have forwarded.

3.6 In-Call Options

To put a call on hold:

Your device notifies you when you have another incoming call, and gives you the choice of rejecting or accepting the call. If you are already on a call and accept the new call, you can choose to switch between the two callers, or set up a conference call between all three parties.

1. Tap **Answer** to take the second call, and put the first one on hold.
2. To end the second call and return to the first call, tap **End**, or press the **End Key**.

To switch between two calls:

- ▶ Press the **Talk Key** on your device.

To set up a conference call:

Conference call, or three-way calling, allows you to talk to two different people at the same time. When using this feature, the normal airtime rates will be charged for each of the two calls.

1. Place the first call, or take an incoming call.
2. Press the **Talk Key** to put the first call on hold, and dial a second number.
3. When you're connected to the second party, press the **Talk Key** to begin the three-way call.

To turn the speakerphone on or off:

The built-in speakerphone on your device allows you to talk hands-free or lets other people listen to the conversation.

- ▶ During a call, tap **Speaker On**, or press and hold the **Talk Key** until the speakerphone turns on. The speakerphone icon () appears in the title bar.
- ▶ To turn off the speakerphone, tap **Speaker Off**, or press and hold the **Talk Key** again until the speakerphone turns off.

Note:

To avoid damage to your hearing, do not hold the device against your ear when the speakerphone is turned on.

To mute a call:

You can turn off the microphone during a call, so that you can hear the caller but the caller cannot hear you.

- ▶ During a call, tap **Mute**.
- ▶ When the microphone is turned off, the mute icon () appears on the screen. Tap **Unmute** to turn on the microphone again.

3.7 Additional Dialing Information

To make an international call:

1. Tap and hold the **0** key on the Phone screen until the **+** sign appears. The **+** replaces the international access code for the location from which you are calling (for example, 011 for international calls placed from the United States).

Tip:

You can change the default international access code. For more information, see “Customizing Plus Code Dialing.”

2. Enter the full phone number you want to dial, and then tap **Talk**. The full phone number includes country code, area code (without the leading zero, if any) and phone number.

3.8 Phone Settings

You can customize phone settings, such as the ring type and ring tone to be used for incoming calls and the keypad tone to be used when entering phone numbers.

To access phone settings:

- ▶ Tap **Start > Settings > Personal tab > Phone**.
- or —
- ▶ Tap **Menu > Options** on the Phone screen.

To change the ring tone:

1. Tap **Start > Settings > Personal tab > Phone > Phone tab**.
2. In the **Ring tone** list, tap the sound you want to use.

Tip:

To use custom ***.wav**, ***.mid**, ***.mp3**, or ***.wma** files as ring tones, use ActiveSync on your PC to copy the file to the **/Windows/Rings** folder on your device. Then, select the sound from the **Ring tone** list.

To change the ring type:

You can change the way that you are notified of incoming calls. For example, you can choose to be notified by a ring, a vibration, or a combination of both.

1. Tap **Start > Settings > Personal tab > Phone > Phone tab**.
2. In the **Ring type** list, tap the desired option.

To change the keypad tone:

You can change the tone you hear when entering a phone number on the keypad. If set to **Long tones**, the tone is heard continuously for as long as the number on the keypad is pressed. Use this setting if you are having trouble completing tasks that rely on tones from your phone, such as accessing messages from an answering machine. If set to **Short tones**, the tone is heard only for one or two seconds. If set to **Off**, no tone will be heard.

1. Tap **Start > Settings > Personal tab > Phone > Phone tab**.
2. In the **Keypad** list, tap the desired option.



3.9 Setting Additional Service Options

Additional phone service options can be easily configured on your device.

To configure additional settings:

1. Tap **Start** > **Settings** > **Personal** tab > **Phone** > **Services** tab.
2. Tap the service you want to use, and then tap **Get Settings**.
3. Select desired options for the service, and then tap **OK**.

The following are some of the phone services that you can configure for your device.

Phone Services	Usage
Location Setting	<p>Allow the mobile phone network to detect your current location via your device's built-in GPS chip. This is especially useful in times of emergency.</p> <p>On the upper right of the Phone screen, one of these icons will be shown:</p> <ul style="list-style-type: none">  LOCATION ON (your location can be detected)  LOCATION OFF (your location cannot be detected except by 911)
Roaming	<p>To better control roaming costs, you can set your device to roam only on certain networks. The Data Roam Guard also helps you to manage your roaming costs. For more information, see "Voice and Data Roaming."</p>
TTY Mode	<p>Allow the use of a TTY (teletypewriter) device with the smart device phone for users who are visually or hearing impaired. Choose one of the following modes, depending on the operation mode that is supported by the TTY device:</p> <ul style="list-style-type: none"> ■ Full mode Send and receive text during an ongoing call. ■ VCO mode Voice Carry Over mode, which allows users to send voice and receive text during an ongoing call. ■ HCO mode Hearing Carry Over mode, which allows users to send text and receive voice during an ongoing call. ■ Off Disable TTY mode, and send and receive voice during an ongoing call.
Internet	<p>Initiate IOTA (Internet-based Over-The-Air provisioning) so that the network can provision your device with the required parameters (such as WAP parameters, roaming lists, etc.) for you to access all available services in a secure manner. Tap Start on the Phone: Internet screen to initiate provisioning.</p>
Time Synchronization	<p>Allow the system time on your device to be synchronized with the time information of the mobile phone network.</p>
Plus Code Dialing	<p>This allows easy dialing when making international calls. For more information, see "Customizing Plus Code Dialing."</p>
Roaming Alert	<p>Enable sound alerts on your device so that you can be notified when your device enters or goes out of the network coverage area. By default, alert notification is disabled.</p>

3.10 Voice and Data Roaming

Your device allows both voice and data roaming if these services are provisioned in your service plan. Contact Sprint to find out about roaming services and rates.

When you are off the Sprint National Network and are within a roaming partner's coverage area, the **Roaming** icon (📶) is shown in the title bar. On the Phone screen, you will also see a “Digital Roaming” status when you are roaming in a digital network or an “Analog Roaming” status when you are within an analog network coverage area.

Setting Roaming Options

You can set roaming options on your device to better control your roaming costs.

1. Tap **Start > Settings > Personal tab > Phone > Services tab**.
2. Select **Roaming**, and then tap **Get Settings**. The Phone: Roaming screen then appears where you can set roaming options.

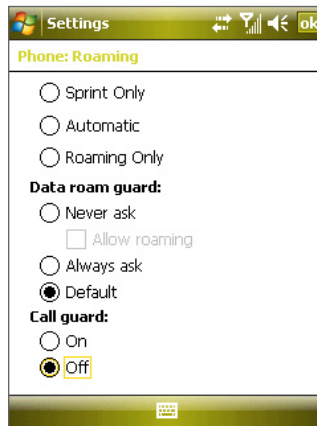

Phone: Roaming screen

To select roaming options::

Choose one of the following options.

- **Sprint Only** to access the Nationwide Sprint PCS Network only and prevent roaming on other networks.
- **Automatic** to seek service on the Sprint National Network.
- **Roaming Only** to force the device to seek a roaming system.

To enable or disable notification and data roaming:

The **Data Roam Guard** helps you to manage your roaming costs by informing you with a notification message and alert before data roaming. Choose one of the following options to enable or disable the notification, and to always allow or disable data roaming.

- ▶ Select **Always ask** to enable the Data Roam Guard to always display a confirmation message and alert whenever your device enters a roaming network.
- ▶ Select **Never ask** and the **Allow roaming** check box to always allow data roaming without prior notification.
- ▶ Select **Never ask** and clear the **Allow roaming** check box to always disable data roaming.

To allow or cancel data roaming:

If notification is enabled, the Data Roam Guard appears with the following confirmation message when your device enters a roaming network:

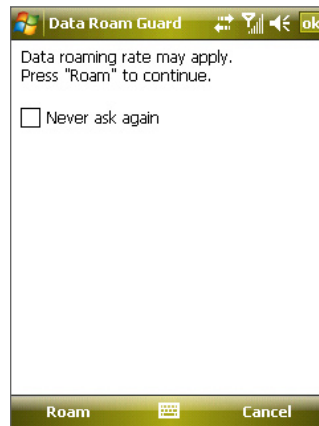

- ▶ Tap **Roam** or **OK** to allow data roaming.
- ▶ Tap **Cancel** if you don't want to allow data roaming.

Note:

If this is your first time to data roam, the Data Roam Guard will display a second message, informing you about how to enable or disable data roaming notification.

3.11 Customizing Plus Code Dialing

You can customize how phone numbers that begin with a plus “+” sign will be dialed.

1. Tap **Start > Settings > Personal tab > Phone > Services tab**, or tap **Menu > Options** on the Phone screen and then tap the **Services** tab.
2. Select **Plus Code Dialing**, and then tap **Get Settings**. The following screen then appears:



3. To place local and international calls from the United States, select **Enable** under **North American dialing**.

When you place calls, the “+” sign at the beginning of phone numbers that you dial will be replaced as follows:

- When you enter a long distance phone number that starts with “+1”, the “+” will be removed and the rest of the number will be dialed. For example, if you entered +1 416 123 4567, the number to be dialed will be 14161234567.
- When you enter an international phone number that starts with a “+” followed by a digit other than 1, the “+” will be replaced with the United States international dialing code, which is already set by default. For example, if you entered +58 212 123 4567, the number to be dialed will be 011582121234567.

Tip: If you modified the international dialing code, you can tap **Reset** to change it back to the default.

Section 4

Setting Up Your Device

In This Section

4.1 Basic Settings

4.2 Personalizing the Today Screen

4.3 Protecting Your Device

4.4 Other Settings



4.1 Basic Settings

Owner Information

Having owner information displayed on the Today screen makes it easier for someone to return your device to you if it is lost.

To enter owner information

1. Tap **Start > Settings > Personal tab > Owner Information**.
2. On the **Identification** tab, enter your personal information.

Tip:

If you don't see owner information on the Today screen, tap **Start > Settings > Personal tab > Today**. On the **Items** tab, select the **Owner Info** check box.

To display owner information when the device is turned on

You can set your device to display the 'my info' screen when power is turned on. This screen shows your complete personal information.

1. Tap **Start > Settings > Personal tab > Owner Information**.
2. On the **Options** tab, select the **Identification information** check box.
3. If you want additional text displayed, tap the **Notes** tab and enter the text (for instance: Reward if found).
4. On the **Options** tab, select the **Notes** check box and then tap **OK**.

Time and Date

To set the time and date:

1. Tap **Start > Settings > System tab > Clock & Alarms > Time** tab.
2. Select the correct time zone and change the date or time.

Note:

During synchronization, the time on your device is updated to the time on your PC.

To set the time and date for a different location:

If you visit or communicate with someone in a particular time zone often, you can select it as your visiting time zone.

1. Tap **Start > Settings > System tab > Clock & Alarms > Time** tab.
2. Tap **Visiting**.
3. Select the correct time zone and change the time or date.

Regional Settings

The style in which numbers, currency, dates, and times are displayed is specified in **Regional Settings**.

1. Tap **Start > Settings > System tab > Regional Settings**.
2. On the **Region** tab, select your region from the list.

Note:

This does not change the Operating System language of your device.

3. The region you select determines which options will be available on the other tabs.
4. To customize settings further, tap the appropriate tabs and select the desired options.

4.2 Personalizing the Today Screen

The Today screen shows your upcoming appointments, active tasks, and information about email messages. You can customize the Today screen on your device.

To customize the Today screen:

1. Tap **Start > Settings > Personal tab > Today**.
2. On the **Appearance** tab, select the desired theme for the background of the Today screen.
3. On the **Items** tab, select the items you want to appear on the Today screen.

Tip:

To change the order of items displayed on the Today screen, tap the item, and then tap **Move Up** or **Move Down**.

To add a custom background image:

You can use one of your own pictures as the background image on the Today screen. Be aware that pictures can affect the readability of text on the Today screen.

1. Tap **Start > Settings > Personal tab > Today**.
2. Select the **Use this picture as the background** check box, and tap **Browse** to view a list of your picture files.
3. Tap the file name of the picture you want to use.
4. Tap **OK**.

To set options for displaying appointments on the Today screen:

If you have a large number of appointments, you may want to specify the kinds of appointments that are displayed on the Today screen.

1. Tap **Start > Settings > Personal tab > Today**.
2. Tap the **Items** tab.
3. Select **Calendar**, and then tap **Options**.
4. Do any of the following:
 - Select **Next appointment** to show only the next appointment in your schedule, or **Upcoming appointments** to show multiple appointments.
 - Clear the **Display all day events** check box if you do not want to display all-day events.

To set options for displaying tasks on the Today screen:

If you have a large number of tasks, you may want to specify the kinds of tasks that are displayed on the Today screen.

1. Tap **Start > Settings > Personal tab > Today**.
2. Tap the **Items** tab.
3. Select **Tasks**, and then tap **Options**.
4. Do any of the following:
 - Under **Display number of**, select the number of tasks you want to appear on the Today screen.
 - In the **Category** list, select whether to display only tasks assigned to a specific category or to display all tasks.

Customizing the Start Menu

To customize the Start Menu:

You can choose which items appear in the Start menu.

1. Tap **Start > Settings > Personal tab > Menus**.
2. Select the check boxes of the items you want to appear in the Start menu. You can select up to seven items.

Tip:

You can also create folders and shortcuts to appear on the Start menu. In ActiveSync on your PC, click Explore. In the Mobile Device window, double-click **My Windows Mobile-Based Device > Windows > Start Menu**, and then create the folders and shortcuts that you want. You will see the added items after you synchronize.

To change the Start Menu display size:

The Large Start Menu feature enlarges the Start menu to make it easier to touch menu items with your fingers. When the Large Start Menu is enabled, recently accessed programs are displayed as icons at the top of the Start menu.

1. Tap **Start > Settings > Personal tab > Large Start Menu**.
2. Select the **Enable large Start menu** check box to enlarge the Start menu or clear the check box to resume the normal display of the Start menu.

4.3 Protecting Your Device

You can prevent unauthorized access to your device by using password protection. To keep your data more secure, you can set your device to prompt for a password every time the device is turned on or when your device has been idle after a specified amount of time.

Protecting Your Device With a Password

You can help keep your data more secure by requiring a password every time the device is turned on. You create your own password when you begin using your device.

To set a device password:

1. Tap **Start > Settings > Personal tab > Lock**.
2. Select the **Prompt if device unused for** check box, and in the box to the right, select how long your device must be turned off before a password is required. In the **Password type** box, select the type of password you would like to use. Enter the password and, if necessary, confirm the password. If your device is configured to connect to a network, use a strong password to help protect network security.
3. On the **Hint** tab, enter a phrase that will help you remember your password, but doesn't allow others to guess your password. The hint will be displayed after an incorrect password is entered four times.
4. Tap **OK**. The next time the device is turned on, you will be prompted to enter your password.

Notes:

Each time an incorrect password is entered, the time the device takes to respond will get longer and longer until the device appears to be not responding.
If you forget your password and cannot access your device anymore, please contact your local authorized dealer to clear memory.

To change your password:

1. Tap **Start > Settings > Personal tab > Lock**. You will be prompted to enter your current password.
2. In the **Password** box, enter your new password.
3. Tap **OK**.

Encrypting Files on Your Storage Card

You can set your device to encrypt files as they are saved on the storage card.

1. Tap **Start > Settings > System tab > Encryption**.
2. Select **Encrypt files placed on storage cards**.

Notes:

Encrypted files can be read only on the device that encrypted them.
Encrypted files are opened just like other files, provided you are using the device that encrypted them. There is no separate step for you to take to read these files.

IMPORTANT:

Before using Clear Storage, using hard reset or updating the ROM system software, please make sure the Encrypt files on your storage card check box is not selected. Otherwise you will no longer be able to access the storage card.

To encrypt files on the storage card after Clear Storage, hard reset or updating the ROM system software, re-select the Encrypt files on your storage card check box.

4.4 Other Settings

Device Name

The device name is used to identify the device in the following situations:

- Synchronizing with a PC
- Connecting to a network
- Restoring information from a backup

Note: If you synchronize multiple devices with the same PC, each device must have a unique name.

To change the device name:

1. Tap **Start > Settings > System tab > About**.
2. Tap the **Device ID** tab.
3. Enter a name.

The device name must begin with a letter, consist of letters from **A** to **Z**, numbers from **0** to **9**, and cannot contain spaces. Use the underscore character to separate words.

Display Settings

To adjust the brightness of the backlight:

1. Tap the **Backlight** icon () on the Today screen, or tap **Start > Settings > System tab > Backlight > Brightness** tab.
2. Move the sliders right to increase and left to decrease the brightness:

To set the backlight to dim after a time delay:

1. Tap the **Backlight** icon () on the Today screen, or tap **Start > Settings > System tab > Backlight**.
2. Tap the **Battery Power** tab or the **External Power** tab.
3. Select the **Turn off backlight if device is not used for** check box, and specify the time delay.

To increase or decrease the size of text on the screen:

1. Tap **Start > Settings > System tab > Screen > Text Size** tab.
2. Move the slider to increase or decrease the text size.

Button Settings

To reassign programs or shortcuts to program buttons:

Your device may come with programs already assigned to hardware buttons. You can customize these buttons to open the programs you use most, or to perform certain shortcuts such as changing the screen orientation, opening the Today screen, or opening the Input Panel.

1. Tap **Start > Settings > Personal tab > Buttons**.
2. A list of buttons and their current assignments is displayed on the **Program Buttons** tab.
3. Tap the button you want to reassign. To help you identify the buttons, there are numbers and icons representing the original function of the button.
4. In the **Assign a program** box, tap the program or shortcut you want to assign.
5. Tap **OK**.

Word Completion Options

Word completion helps you enter text faster by suggesting words as you enter letters using one of the input methods. You can set the number of suggested words to display, when to show the word list, and more.

1. Tap **Start > Settings > Personal tab > Input > Word Completion** tab.
2. Make sure the **Suggest words when entering text** check box is selected.
3. By default, the suggested word list appears whenever you enter a space. To make the word list appear after letters are entered, select the number of letters that you want to be entered before displaying the word list.
4. The suggested word list shows up to four words by default. You can change the number of words to display in the suggested list.
5. Make sure the **Enable Auto Correct** check box is selected if you want mistyped words to be corrected automatically.

Tip:

The word database learns and adds more words as you enter new words during text entry. To delete the added words and reset the database back to the default, tap **Clear Stored Entries**.

Alarms and Notifications

To set an alarm:

1. Tap **Start > Settings > System tab > Clock & Alarms > Alarms** tab.
2. Tap **<Description>** and enter a name for the alarm.
3. Tap the day of the week for the alarm. You can select multiple days by tapping each desired day.
4. Tap the time to open a clock and set the time for the alarm.
5. Tap the alarm icon () to specify the type of alarm you want. You can choose a flashing light, a single sound, a repeating sound, or vibration.
6. If you choose to play a sound, tap the list next to the **Play sound** check box and tap the sound you want.

To choose how to be notified about events or actions:

1. Tap **Start** > **Settings** > **Personal** tab > **Sounds & Notifications**.
2. On the **Sounds** tab, choose how you want to be notified by selecting the appropriate check boxes.
3. On the **Notifications** tab, in **Event**, tap an event name and choose how you want to be notified by selecting the appropriate check boxes. You can choose from several options, such as a special sound, a message, or a flashing light.

Tip:

Turning off sounds and the flashing light helps conserve battery power.

Section 5

Synchronizing Information With Your Computer

In This Section

- 5.1 About Synchronization
 - 5.2 Setting Up Windows Mobile® Device Center on Windows Vista™
 - 5.3 Setting Up ActiveSync® on Windows XP®
 - 5.4 Synchronizing With Your Computer
 - 5.5 Synchronizing via Bluetooth
 - 5.6 Synchronizing Music and Videos
-



5.1 About Synchronization

You can take information from your computer wherever you go by synchronizing them to your device. The following types of information can be synchronized between your computer and your device:

- **Microsoft Outlook® information**, which include Outlook email, contacts, calendar, tasks, and notes
- **Media**, such as pictures, music and video
- **Favorites**, which are the bookmarked links to your favorite Web sites
- **Files**, such as documents and other files

Before you can synchronize, you need to install and set up first the synchronization software on your computer. For more information, see “Setting Up Windows Mobile Device Center on Windows Vista™” and “Setting Up ActiveSync® on Windows XP®.”

Ways to Synchronize

After you have installed the synchronization software to your computer, connect and synchronize your device with your computer by using one of the following methods:

- Connect and synchronize using the supplied USB sync cable. Upon connecting the sync cable to your device and your computer, the synchronization process starts automatically.
- Connect and synchronize using Bluetooth. You must first set up a Bluetooth partnership between your device and your computer before you can synchronize information between them using Bluetooth. For more information about setting up a Bluetooth partnership, see Section 11. For information about synchronizing through Bluetooth, see “Synchronizing via Bluetooth” later in this Section.

Try to synchronize frequently in order to keep information up-to-date in both your device and your computer.

Note:

You can also synchronize Outlook email, contacts, calendar, and tasks on your device with the Exchange Server at your work. For more information about setting up your device to synchronize with the Exchange Server, see Section 8.

5.2 Setting Up Windows Mobile® Device Center on Windows Vista™

Microsoft Windows Mobile® Device Center is the replacement for Microsoft® ActiveSync® on Windows Vista™.

Note:

Some versions of Windows Vista come with Windows Mobile Device Center already installed. If Windows Mobile Device Center is not available on your Windows Vista, you can install it from the Software Installation CD that came with your device.

Setting Up Synchronization in Windows Mobile Device Center

When you connect your device to your PC and start Windows Mobile Device Center for the first time, you are asked to create a Windows Mobile partnership with your device. Follow the steps below to create a partnership.

1. Connect your device to your PC. Windows Mobile Device Center configures itself and then opens.
2. On the license agreement screen, click **Accept**.
3. On the Windows Mobile Device Center's Home screen, click **Set up your device**.

Note:

Choose **Connect without setting up your device** if you only want to transfer media files, check for updates, and explore your device without synchronizing Outlook information.

4. Select the information types that you want to synchronize, and then click **Next**.
5. Enter a device name and click **Set Up**.

When you finish the setup wizard, Windows Mobile Device Center synchronizes your device automatically. Notice that Outlook email messages and other information will appear on your device after synchronization.

Using Windows Mobile Device Center

To open Windows Mobile Device Center, click **Start > All Programs > Windows Mobile Device Center** on your Windows Vista PC.

On Windows Mobile Device Center, you can do the following:



- Click **Mobile Device Settings** to view and change synchronization settings.
- When you click **Pictures, Music and Video > _ new pictures/video clips are available for import**, a wizard guides you to tag and transfer photos from your device to the Photo Gallery on your Windows Vista PC.
- Click **Pictures, Music and Video > Add media to your device from Windows Media Player** to synchronize music and video files using Windows Media™ Player. For more information, see “Using Windows Media™ Player” in Section 12.
- Click **File Management > Browse the contents of your device** to view documents and files from your device.

Note:

See Windows Mobile Device Center Help for more information.

5.3 Setting Up ActiveSync® on Windows XP®

The Software Installation CD that comes with your device contains Microsoft ActiveSync 4.5 or later. Follow the steps in this section to install and set up ActiveSync on Windows XP or other compatible Windows systems.

Note:

For a list of compatible Windows systems, please go to:
<http://www.microsoft.com/windowsmobile/activesync/activesync45.mspix>

Installing ActiveSync

1. Insert the Software Installation CD into the disc drive on your PC.
2. Click **Setup and Installation**.
3. Select the **ActiveSync** check box and click **Install**.
4. Read the license terms and click **Accept**.
5. When installation is complete, click **Done**.
6. On the Getting Started with Windows Mobile screen, click **Close**.

Setting Up Synchronization in ActiveSync

Follow the steps below to set up a synchronization partnership.

1. Connect your device to your PC. The Synchronization Setup Wizard automatically starts and guides you to create a synchronization partnership. Click **Next** to proceed.
2. To synchronize your device with your PC, clear the **Synchronize directly with a server running Microsoft Exchange** check box and then click **Next**.
3. Select the information types that you want to synchronize and then click **Next**.
4. Select or clear the **Allow wireless data connections** check box according to your preference.
5. Click **Finish**.

When you finish the wizard, ActiveSync synchronizes your device automatically. Notice that Outlook email and other information will appear on your device after synchronization.

5.4 Synchronizing With Your Computer

Connect and synchronize your device with your PC using the USB Sync cable or Bluetooth connection.

Starting and Stopping Synchronization

You can manually synchronize either from your device or PC.



From your device

1. Tap **Start > Programs > ActiveSync**.
2. Tap **Sync**. To end synchronization before it completes, tap **Stop**.

Tip:



To delete a partnership with one PC completely, tap **Menu > Options**, tap the computer name, and then tap **Delete**.

From Windows Mobile Device Center

1. Click **Start > All Programs > Windows Mobile Device Center**.
2. Click  at the lower left of the Windows Mobile Device Center. To end synchronization before it completes, click .

From ActiveSync on your PC

When you connect your device to your PC, ActiveSync automatically opens on your PC and synchronizes.

- To manually start synchronization, click .
- To end synchronization before it completes, click .

Changing Which Information Is Synchronized

You can change the information types and the amount of information to synchronize for each type either on your device or your PC. Follow the steps below to change synchronization settings on your device.

Note:

Before changing synchronization settings on your device, disconnect it from your PC.

1. In ActiveSync on the device, tap **Menu > Options**.
2. Select the check box for any items you want to synchronize. If you cannot select a check box, you might have to clear the check box for the same information type elsewhere in the list.
3. To change synchronization settings for an information type, for instance, **E-mail**, select it and tap **Settings**. You can then set the download size limit, specify the time period of information to download, and more.

Notes:

Some information types such as Favorites, Files and Media cannot be selected in ActiveSync Options on your device. You can only select or clear these items from your PC's Windows Mobile Device Center or ActiveSync.

A PC can have sync partnerships with many different Windows Mobile powered devices, but a device can have sync partnerships with at most two PCs only. To ensure that your device will synchronize properly with both PCs, set up the second PC using the same synchronization settings you used on the first PC.

Outlook email can be synchronized with only one computer

Troubleshooting Sync Connection Problems

When the PC is connected to the Internet or a local network, in some cases the PC may disconnect the connection with your device in favor of the Internet or network connection.

If this happens, tap **Start > Settings > Connections** tab > **USB to PC**, and then clear the **Enable advanced network functionality** check box. This makes your PC utilize a serial USB connection with your device.

The USB to PC () icon appears on the Today Screen when a serial USB connection is used.

5.5 Synchronizing via Bluetooth

You can connect and synchronize your device with the PC using Bluetooth.

To synchronize with a computer via Bluetooth:

1. Set up Windows Mobile Device Center or ActiveSync on your PC to synchronize through Bluetooth. See the program's Help for instructions.
2. On your device, tap **Start > Programs > ActiveSync**.
3. Make sure that Bluetooth on both your device and the computer are turned on and set to visible mode. For more information, see "Using Bluetooth" in Section 11.
4. Tap **Menu > Connect via Bluetooth**. Make sure the Bluetooth function of both your device and the computer are turned on and set to visible mode.
5. If this is the first time you have connected to this computer via Bluetooth, you must first complete the Bluetooth wizard on your device and set up a Bluetooth partnership between your device and the computer. For more information about creating a Bluetooth partnership, see "Bluetooth partnerships" in Section 11.

Notes:

To preserve battery power, turn off Bluetooth when not in use.

To connect and synchronize your device with a computer via Bluetooth, your computer must have built-in Bluetooth or an installed Bluetooth adapter or dongle.

5.6 Synchronizing Music and Videos

If you want to carry your music or other digital media along with you while you travel, set up Microsoft® Windows Media® Player on your computer to synchronize music and video with your device.

Other than selecting the **Media** information type to be synchronized, all media synchronization settings must be set in Windows Media Player. Before media can be synchronized, you must do the following:

- Install Windows Media Player Version 11 on the PC. (Windows Media Player 11 works only in Windows XP or later versions).
- Connect your device to the PC with a USB Sync cable. If your device is currently connected using Bluetooth, you must end that connection before media can be synchronized.
- **Set up a sync partnership between your device and your PC's Windows Media Player.**

For more information about using Windows Media Player on your device, see Section 12.

Section 6

Organizing Contacts, Appointments, Tasks, and Other Information

In This Section

6.1 Contacts

6.2 Calendar

6.3 Tasks

6.4 Notes



6.1 Contacts

Contacts is your address book and information storage for the people and businesses you communicate with. There are two types of contacts that you can create on your device:

- **Outlook contacts.** Contacts that are stored on your device, which can be created on your device or synchronized with your PC or the Exchange Server. For each contact, you can store phone numbers, email addresses, instant messaging (IM) names, company and home addresses, and information such as a job title, birthday, and a lot more. You can also add a picture and assign a ringer to an Outlook contact.
- **Windows Live contacts.** Contacts that you communicate with using Windows Live Messenger or MSN. Just like Outlook contacts, you can also enter complete information for a Windows Live contact. For more information, see “Adding Windows Live Contacts” in Section 9.

Note:	You can only add Windows Live contacts after you have set up Windows Live on your device.
--------------	---

Adding New Contacts

To add a contact on your device:

1. Tap **Contacts** on the Today screen.
2. Tap **New**, and then enter the contact information.
3. In the **File as** field, choose how you want the contact name to appear in the Contacts list.
4. To add a photo of the contact, tap **Select a picture**, and then select the picture file or tap **Camera** to take a photo of the contact. This photo appears on the Phone screen when you receive a call from the contact.
5. To assign a ringer to the contact, tap the Ring tone field, scroll through the list of tones, and then select a desired tone.
6. When you are finished, tap **OK**.

Tips:	If someone who is not in your list of contacts calls you or sends you a message, you can create a contact from Call History, or from the message by tapping Menu > Save to Contacts . To save a phone number that is contained in a message, tap the phone number, and then tap Menu > Save to Contacts . In the list of contact information, you'll see where you can add a picture or assign a ringer to a contact.
--------------	---

To change contact information:

1. Tap **Contacts** on the Today screen.
2. Tap the contact.
3. Tap **Menu > Edit** and enter the changes.
4. When you are finished, tap **OK**.

Organizing and Searching

To group similar contacts

You can group similar contacts for easier management by assigning them to categories.

1. Create a new Outlook contact, or select an existing Outlook contact to edit.
2. Tap **Categories**.
3. Select a preset category such as Business or Personal, or tap **New** to create your own category.
4. When finished, tap **OK**.

To view contacts by category, tap **Menu > Filter**, and then select the desired category.

Note:

If your Contacts list has been filtered by a category, that category is automatically assigned when you create a new contact.

To work with the Contacts list:

There are several ways to use and customize the Contacts list. Here are a few tips:

1. Tap **Contacts** on the Today screen.
2. In the Contacts list, do any of the following:
 - In Name view, you can search for a contact by entering a name or number, or by using the alphabetical index. To switch to Name view, tap **Menu > View By > Name**.
 - To see a summary of information about a contact, tap the contact. From there you can also make a call or send a message.
 - To see a list of available actions for a contact, tap and hold the contact.
 - To see a list of contacts employed by a specific company, tap **Menu > View By > Company**. Then, tap the company name.

To find a contact on your device:

There are several ways to find a contact in your Contacts list.

1. Tap **Contacts** on the Today screen.
2. If you are not in Name view, tap **Menu > View By > Name**.
3. Do one of the following:
 - Begin entering a name or phone number in the provided text box until the contact you want is displayed. To show all contacts again, tap the text box and clear the text, or tap the arrow to the right of the text box.
 - Use the alphabetical index displayed at the top of the Contacts list.
 - Filter the list by categories. In the Contacts list, tap **Menu > Filter**. Then tap a category you've assigned to a contact. To show all contacts again, select **All Contacts**.

Sharing Contact Information

You can quickly send contact information to another mobile phone or device through Bluetooth beaming.

1. Tap **Contacts** on the Today screen, and then select a contact.
2. Tap **Menu > Send Contact > Beam**.
3. Select a device where to beam the contact to.

Note:

Before you can beam, make sure Bluetooth is turned on and set to visible mode on your device and the target mobile device. You can also beam contact information to your PC. For more information, see "Using Bluetooth" in Section 11.

6.2 Calendar

Use **Calendar** to schedule appointments, including meetings and other events. Your appointments for the day can be displayed on the Today screen. If you use Outlook on your PC, you can synchronize appointments between your device and PC. You can also set Calendar to remind you of appointments with a sound or flashing light, for example.

You can look at your appointments in several different views (Day, Week, Month, Year, and Agenda). To see detailed appointment information in any view, tap the appointment.

Creating Appointments

To schedule an appointment:

1. Tap **Calendar** on the Today screen.
2. Tap **Menu > New Appointment**.
3. Enter a name for the appointment.
4. Do one of the following:
 - If it is a special occasion such as a birthday or a whole-day event, set the **All Day** option to **Yes**.
 - If there is a time frame for the appointment, select the start and end dates and time.
5. Specify the type of category for your appointment, so that it can be grouped with other related appointments. Tap **Categories**, and then select a preset category (Business, Holiday, Personal, or Seasonal), or tap **New** to create your own category.
6. When you are finished, tap **OK** to return to the calendar.

Notes:

All-day events do not occupy blocks of time in the calendar; instead, they appear in banners at the top of the calendar.

To cancel an appointment, tap the appointment, and then tap **Menu > Delete Appointment**.

Tip:

To have the time entered automatically in Day view, tap the time slot for the new appointment, and then tap **Menu > New Appointment**.

To set a default reminder for all new appointments:

You can have a reminder automatically turned on for all new appointments you schedule.

1. Tap **Calendar** on the Today screen.
2. Tap **Menu > Tools > Options > Appointments** tab.
3. Select the **Set reminders for new items** check box.
4. Set the time you want to be alerted.
5. Tap **OK** to return to the calendar.

Viewing Appointments

By default, Calendar displays appointments in Agenda view. You can also look at your appointments in **Day**, **Week**, **Month**, and **Year** views.

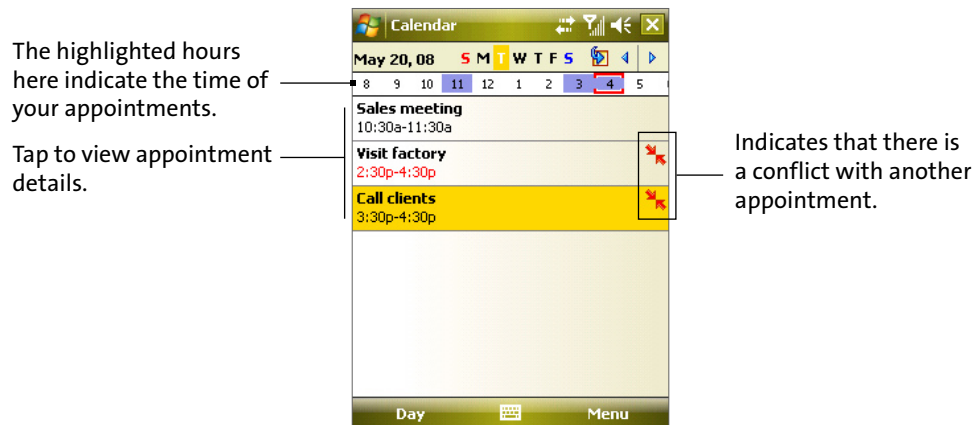

- To see detailed appointment information in any view, tap the appointment.
- To view appointments by category, tap **Menu > Filter**, and then select the desired category.
- To change the default view that Calendar uses to display appointments, tap **Menu > Tools > Options > General** tab. Tap the **Start in** box, and then choose the calendar view.
- When in Month view, you will see the following indicators:

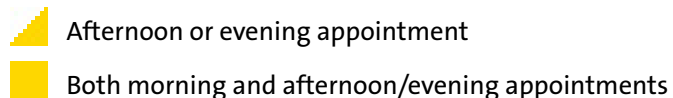
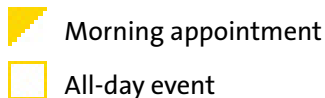

Sending Appointments

To send a meeting request:

Use Calendar to schedule meetings via email with contacts who use Outlook or Outlook Mobile.

1. Tap **Calendar** on the Today screen.
2. Schedule a new appointment, or open an existing one and tap **Menu > Edit**.
3. Tap **Attendees**, tap **Add Required Attendee** or **Add Optional Attendee**, and add the contacts you want to invite.

You can specify if an attendee is required or optional only if your device is connected to a Microsoft Exchange 2007 server. Otherwise, all attendees are designated as required. For more information, see Section 8.

4. When have finished adding attendees, tap **Done**.
5. Tap **OK** to send.

Tip:

To choose the email account to use for sending meeting requests, tap **Menu > Tools > Options > Appointments** tab. Tap the **Send meeting requests via** box and choose to send via your Outlook Email, POP3/IMAP4 or Windows Live account.

Notes:

If you're sending the meeting request using your Outlook Email account, it will be sent to the attendees the next time you synchronize your device with your PC or Exchange Server.

When attendees accept your meeting request, the meeting is automatically added to their schedules. When their responses are sent back to you, your calendar is updated as well.

6.3 Tasks

Use **Tasks** to keep track of things you need to do. A task can occur once or repeatedly (recurring). You can set reminders for your tasks and you can organize them using categories.

Your tasks are displayed in a task list. Overdue tasks are displayed in red.

To create a task:

1. Tap **Start > Programs > Tasks**.
2. Tap **New**, enter a subject for the task, and fill in information such as start and due dates and priority.
3. Specify the type of category for your task, so that it can be grouped with other related tasks. Tap **Categories**, and then select a preset category (Business, Holiday, Personal, or Seasonal), or tap **New** to create your own category.
4. When you are finished, tap **OK**.

Tip:

You can easily create a short, to-do type of task. Simply tap the **Tap here to add a new task** box, enter a subject, and press **ENTER**. If the task entry box is not available, tap **Menu > Options** and select the **Show Tasks entry bar** check box.

To change the priority of a task:

Before you can sort tasks by priority, you need to specify a priority level for each task.

1. Tap **Start > Programs > Tasks**.
2. Tap the task for which you want to change the priority.
3. Tap **Edit**, and select a priority level in the **Priority** box.
4. Tap **OK** to return to the task list.

Note:

All new tasks are assigned a Normal priority by default.

To set a default reminder for all new tasks:

You can have a reminder automatically turned on for all new tasks you create.

1. Tap **Start > Programs > Tasks**.
2. Tap **Menu > Options**.
3. Select the **Set reminders for new items** check box.
4. Tap **OK** to return to the task list.

Note:

The new tasks must have due dates set in order for the reminder to take effect.

To show start and due dates in the task list:

1. Tap **Start > Programs > Tasks**.
2. Tap **Menu > Options**.
3. Select the **Show start and due dates** check box.
4. Tap **OK**.

To locate a task:

When your task list is lengthy, you can display a subset of the tasks or sort the list to quickly find a specific task.

1. Tap **Start > Programs > Tasks**.
2. In the task list, do one of the following:
 - Sort the list. Tap **Menu > Sort by**, and tap a sort option.
 - Filter the list by category. Tap **Menu > Filter**, and tap the category you want displayed.

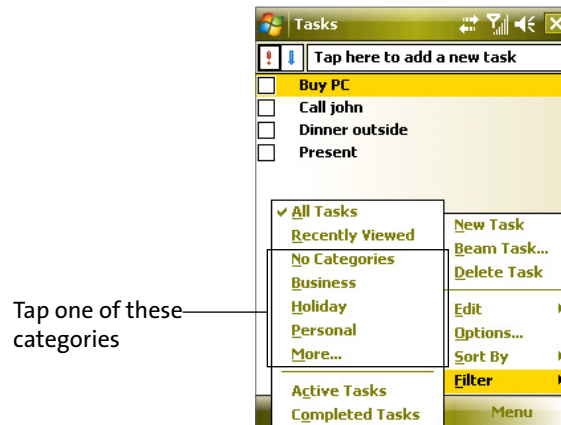

Tip:

To filter your tasks further, tap **Menu > Filter > Active Tasks** or **Completed Tasks**.

6.4 Notes

Notes helps you to quickly capture thoughts, questions, reminders, to-do lists, and meeting notes. You can create handwritten and typed notes, record voice notes, convert handwritten notes to text for easy readability, and send notes to others.

Entering Information in Notes

There are several ways to enter information in a note. You can enter typed text by using the onscreen keyboard or handwriting recognition software. You can also use the stylus to write or draw directly on the screen.

To set the default input mode for Notes:

If you frequently add drawings to your notes, you may find it helpful to set **Writing** as the default input mode. If you prefer typed text, select **Typing**.

1. On your device, tap **Start > Notes**.
2. In the note list, tap **Menu > Options**.
3. In the **Default mode** box, tap one of the following:
 - **Writing** if you want to draw or enter handwritten text in a note.
 - **Typing** if you want to create a typed note.
4. Tap **OK**.

To create a note:

1. Tap **Start > Notes**.
2. In the note list, tap **New**.
3. Tap the **Input Selector** arrow to select the input method you want, and enter your text.
4. If the **Input Selector** arrow is not displayed, tap the **Input Panel** icon.
5. When you are finished, tap **OK** to return to the note list.

Note:

To select handwritten text, tap and hold near the text. As soon as dots appear, and before they form a complete circle, quickly drag across the text. (If a letter crosses three ruled lines, it is treated as a drawing rather than text.)

To draw in a note:

1. Tap **Start > Notes**.
2. In the note list, tap **New**.
3. Draw on the screen, crossing at least three ruled lines. (A selection box labeled **Drawing** appears around your drawing.)
4. When you are finished, tap **OK** to return to the note list.

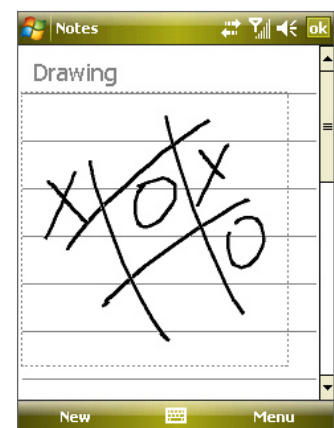

Drawing on the screen

Note:

To select a drawing (for example, to copy or delete it), tap and hold the drawing briefly. When you lift the stylus, the drawing is selected.



Recording Voice Notes

You can create a stand-alone recording (voice note) or you can add a recording to a note.

To create a voice note:

1. Tap **Start > Notes**.

From the note list, you can directly record a voice note. If you want to embed a recording into a note, create or open a note first.

2. If you do not see the Recording toolbar, tap **Menu > View Recording Toolbar**.
3. Tap the record icon () to begin recording.
4. Hold your device's microphone near your mouth or other source of sound.
5. Tap the stop icon () when finished recording.
6. If you are adding a recording to a note, tap **OK** to return to the note list when finished.
7. If you are recording in an open note, an icon will appear in the note.
8. If you are creating a stand-alone recording, the recording will appear in the note list.

Tip:

To quickly create a recording, press and hold the Voice Command Key, and then you can begin to record after a beep sound. Release the button when you are finished.

To change recording formats:

1. Tap **Start > Settings > Personal tab > Input**.
2. Tap the **Options** tab, and in the Voice recording format list, tap the format you want.
3. Tap **OK**.

Note:

You can also change recording formats from within Notes. In the note list, tap **Menu > Options > Global Input Options** link (at the bottom of the page), and then tap the **Options** tab.

Section 7

Exchanging Messages

In This Section

7.1 Messaging

7.2 Text Messages

7.3 Setting Up Email Accounts

7.4 Using Email



7.1 Messaging

Messaging is where your text (SMS) and email messages are located. When you receive new messages, you can open them from the Today screen. Simply tap the type of message that you want to open.

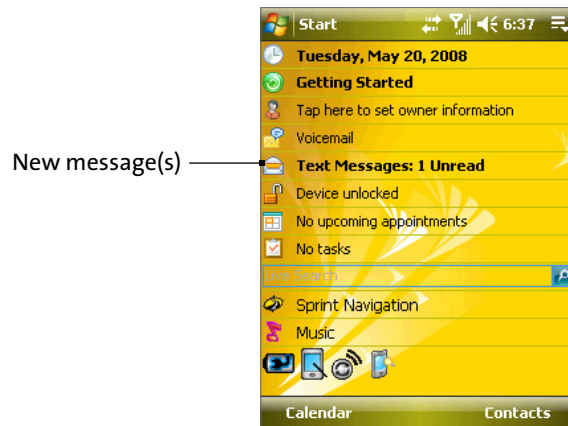

To select a messaging account:

- ▶ Tap **Start > Programs > Messaging**. The Account Selection screen then appears where you can select an account.
—or—
- ▶ From within one account's message list (for example, Text Messages), tap **Menu > Go To** to switch to another messaging account.

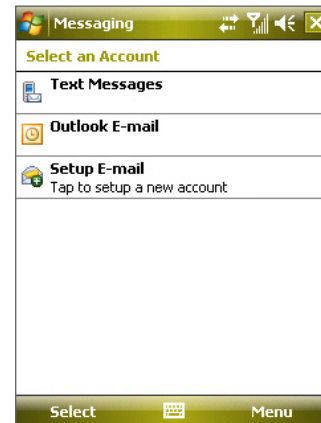

Account Selection screen

To configure message account settings:

- ▶ Tap **Menu > Options** on the Account Selection screen.
—or—
- ▶ Tap **Menu > Tools > Options** while you're in a message list.

7.2 Text Messages

Send short text messages (SMS) up to 160 characters long to other mobile phones. For quicker and easier typing, use the sliding keyboard to enter your message.

Sending Text Messages

To compose and send a text message

1. Tap **Start** > **Programs** > **Messaging**.
2. Tap **Text Messages** on the Account Selection screen.
3. Tap **Menu** > **New**.
4. Enter the mobile phone number of one or more recipients, separating them with a semicolon. To access mobile phone numbers from Contacts, tap **To**.
5. Enter your message.
 - To quickly add common messages, tap **Menu** > **My Text** and tap a desired message.
 - To check the spelling, tap **Menu** > **Spell Check**.

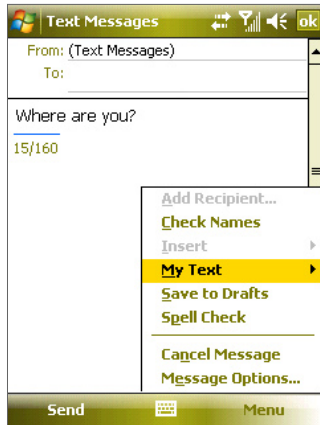

6. Tap **Send**.

Tips:

To enter symbols, tap **123** using the onscreen keyboard.

To set the priority, tap **Menu** > **Message Options**.

If you are working offline, email messages are moved to the Outbox folder and will be sent the next time you connect.

If you want to know when a text message is received, before sending the message that you are composing, tap **Menu** > **Message Options**, and then select the **Request message delivery notification** check box. To always receive a delivery notification, tap **Menu** > **Tools** > **Options** in the text message list, tap **Text Messages**, and then select the **Request delivery notifications** check box.

Receiving Text Messages

Text messages are automatically received when the phone function is turned on. When the phone is turned off, text messages are held by your wireless service provider until the next time the phone is turned on.

Threaded SMS

Text messages that are sent to and received from a contact (or number) are grouped as a single thread in your inbox. Threaded SMS lets you see exchanged messages (similar to a chat program) with a contact on the screen.

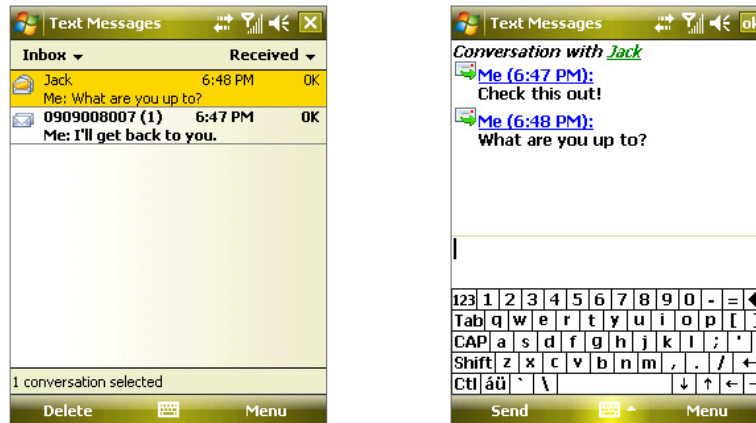

To reply to a text message:

1. In the Text Messages Inbox, tap a message thread to open it.
2. At the bottom of the screen, type your reply message and then tap **Send**.



To delete a message in the thread:

1. In the Text Messages Inbox, tap the message to open it.
2. Select the message in the thread you want to delete.
3. Tap **Menu > Delete**.

7.3 Setting Up Email Accounts

Types of Email Accounts

Before you can send and receive email, you need to set up your email account on your device. You can set up the following types of email accounts on your device:

- Outlook email that you synchronize with your PC or your company's Exchange Server
- Email account that you have from an Internet Service Provider (ISP)
- Work account that you access using a VPN connection
- Other Web-based email accounts such as Gmail®, Yahoo!® Mail Plus, etc.

E-mail Setup Wizard

Windows Mobile's **E-mail Setup wizard** walks you through the process of setting up your email account. It has an Auto Setup feature which can automatically set up your email account based on the email address and password that you enter, if your email provider settings are preconfigured on your device. If the settings are not found on your device, Auto Setup then attempts to retrieve the settings online for which you may be charged when your device connects to the Internet and downloads them. If it cannot find the email settings online, you need to enter them manually.

Note: For more information about setting up your company Outlook email account, see Section 8.

To set up a POP3 or an IMAP4 email account:

Set up a POP3 or an IMAP4 email account on your device if you have an email account from an Internet service provider (ISP) or other email provider, or a Web-based account such as Gmail or Yahoo! Mail Plus. You can also add a work account that you access using a VPN server connection as a POP3 or an IMAP4 account.

1. Tap **Start > Programs > Messaging**.
2. Tap **Setup E-mail** on the Account Selection screen.
3. Enter the **E-mail address** and **Password** for the email account and select the **Save password** option. Tap **Next**.
4. If email provider settings are found preconfigured on your device, the Email Setup wizard shows a successful message. Tap **Next**.

If the settings are not found on your device, select the **Try to get e-mail settings automatically from the Internet** checkbox to find and download email server settings from the Internet and then tap **Next**.

5. Enter **Your name** and the **Account display name** and then tap **Next**.

Note: If the Email Setup wizard was unsuccessful in finding and downloading settings from the Internet, select **Internet e-mail** from the **Your e-mail provider** list on the next screen. You will be asked to enter email server settings. See "To specify email server settings" for details.

6. In the **Automatic Send/Receive** list, choose how frequent you want email messages to be automatically sent and downloaded on your device.

Note: Tap **Review all download settings** to select download options, set the email format as HTML or plain text, and more. For more information, see "To customize download and format settings."

7. Tap **Finish**.

To specify email server settings:

If Auto Setup is unsuccessful, contact your ISP or email provider for the **Incoming mail server** and **Outgoing mail server** settings so you can enter them on your device.

Other options that you can select include the following:

- Select the **Outgoing server requires authentication** check box, if required by your provider.
- If the outgoing email server requires a different user name and password for sending email, clear the **Use the same user name and password for sending e-mail** check box. You will be prompted to enter this information.
- Tap **Advanced Server Settings**, and then select the **Require SSL** check boxes if your email provider uses an SSL connection for more secured email. From the **Network connection** list, select the data connection that you use for connecting to the Internet.

To customize download and format settings:

Before you tap **Finish** when setting up your POP3 or IMAP4 email account, you can tap **Review all download settings** to choose download options, message format, and other settings.

Options	Description
Automatic Send/Receive	You can select a time interval for connecting to the Internet automatically to send and receive messages.
Download messages	Set the number of days of messages that you want to be downloaded to your device.
Send/receive when I click Send	By default, messages are immediately delivered when you tap Send. If you prefer to save outgoing messages to the Outbox folder first, clear the check box. (In this case, you will need to manually send messages by tapping Menu > Send/Receive).
Use automatic send/receive schedule when roaming	This allows your device to data roam when there is a set time interval for connecting to the Internet automatically. Since this may result in higher connection costs, you may want to leave the check box cleared.
When deleting messages	Choose whether to delete messages from the mail server when you delete them on your device.
Message format	Select HTML or Plain Text.
Message download limit	Select the email download size. If you have large volumes of email, use a lower size or select to download headers only.

Set up a custom domain email

When you are using an email domain name that is hosted by a different email provider (for example, your email address may be Benjamin@startup.com but Email.com hosts the email account and provides email services), you can clear the **Try to get e-mail settings automatically from the Internet** option and then select the **Custom Domain** option in the E-mail Setup wizard to set up your email account on your device.

7.4 Using Email

After setting up email accounts on your device, you can start sending and receiving email messages.

Creating and Sending Messages

To compose and send a message:

1. Tap **Start > Programs > Messaging**, and then select an email account.
2. Tap **New**.
3. Enter the email address of one or more recipients, separating them with a semicolon. To access addresses from Contacts, tap **To**.
4. Enter your message. To quickly add common messages, tap **Menu > My Text** and tap a desired message.
5. To check the spelling, tap **Menu > Spell Check**.
6. Tap **Send**.

Tips:

To enter symbols, tap **123** using the on-screen keyboard. To access more symbols, use the Symbol Pad. See Section 2 for details.

To set the priority, tap **Menu > Message Options**.

If you are working offline, email messages are moved to the Outbox folder and will be sent the next time you connect.

To add an attachment to a message:

1. In a new message, tap **Menu > Insert** and tap the item you want to attach: **Picture**, **Voice Note**, or **File**.
2. Select the file you want to attach, or record a voice note.

Filtering the Inbox Message List

When the Inbox on your device is full of messages, it may be hard to browse and locate a desired message. You can filter your Inbox to only display the messages that contain a particular sender or subject you are searching for.

To filter your Inbox:

- ▶ Enter the sender name or email subject you want to look for using the on-screen keyboard. As you tap keys, the message list narrows down to the conditions you have set.

For example, tapping “S” and then “A” narrows the list to only the email messages that contain sender names and email subjects that start with “SA.”

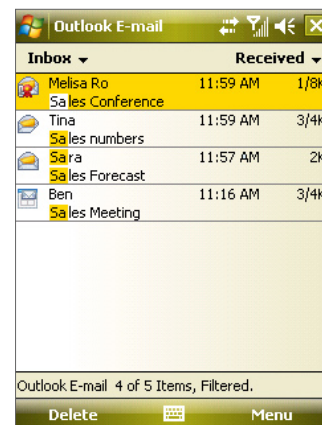

Viewing and Replying to Messages

To read an incoming message:

By default, only the first few kilobytes of a message are shown when you open an incoming message. To read the whole message, do one of the following:

- ▶ In the message list, select a message and then tap **Menu > Download Message**.
- or —
- ▶ Open a message. Scroll down to the end of the message and then tap **Get the rest of this message**.

The message will be downloaded the next time you tap **Menu > Send/Receive** to send and receive email.

Notes:	<p>If your company is running Microsoft Exchange Server 2007, the message downloads immediately, without waiting until the next time you synchronize. For more information about working with company email, see Section 8.</p> <p>The size column in the message list displays the local size and server size of a message. Even when an entire message has been downloaded, these numbers may differ because the size of a message can vary between the server and the device.</p>
---------------	--

To download an attachment:

An attachment appears below the subject of the message. Tapping the attachment opens the attachment if it has been fully downloaded or marks it for download the next time you send and receive email.

Notes:	<p>If there are multiple attachments in the message, all attachments are downloaded.</p> <p>For information about setting your device to automatically download file attachments, see “Customizing Email Settings.”</p> <p>If your company is running Microsoft Exchange Server 2007, the attachment downloads immediately, without waiting until the next time you synchronize. For more information about working with company email, see Section 8.</p>
---------------	--

To reply to or forward a message:

1. Open the message and tap **Menu > Reply**, **Menu > Reply All**, or **Menu > Forward**.
2. Enter your response. To quickly add common messages, tap **Menu > My Text** and tap a desired message.
3. To check the spelling, tap **Menu > Spell Check**.
4. Tap **Send**.

Tips:	<p>To see more header information, scroll up.</p> <p>To always include the original message, from the list view, tap Menu > Tools > Options > Message tab, and select the When replying to e-mail, include body check box.</p> <p>In the Outlook Email account, you will send less data if you do not edit the original message. This may reduce data transfer costs based on your rate plan.</p>
--------------	--

To view and reply to email formatted in HTML:

You can receive, view and reply to HTML email from any type of email account. The HTML format is retained, without layout shifting or resizing.

Note: HTML email support in Outlook Mobile is available only if your company is using **Microsoft Exchange Server 2007**.

1. Set the message format to HTML. To find out how to set the message format, see “Customizing Email Settings.”
2. Tap **Start > Programs > Messaging**, select your email account, and open an HTML email that you received.
3. Tap the **Tap to scroll right** option to be able to scroll sideways and get a complete horizontal view of the message.
4. Tap **Get the rest of this message** that’s shown at the bottom of the message to download and view the whole message.
5. If the email message does not download immediately, tap **Menu > Send/Receive**.
6. If images do not immediately appear on the message, tap **Internet pictures blocked**, and then tap **Download Internet pictures**.
7. Tap **Menu** and choose whether to reply to the sender(s) or forward the message.
8. Enter your response and then tap **Send**.

Tip: Email can contain hyperlinks to Web pages.

Synchronize Emails

Synchronizing emails ensures that new emails are downloaded to the device Inbox folder, emails in the Outbox folder are sent, and emails deleted from the server are removed from your device. The manner in which you synchronize emails depends on the type of email account you have.

To automatically synchronize an Outlook email account:

1. Connect your device to your computer through USB or Bluetooth. Otherwise, connect through a data connection if you are synchronizing Outlook email with the Exchange Server.
2. Synchronization automatically begins, and your device sends and receives Outlook email.

To manually synchronize your Outlook or Internet email account:

1. Select your Internet email account.
2. Tap **Menu > Send/Receive**.

Customizing Email Settings

To change the download size and format for Outlook email:

1. Disconnect your device from the computer.
2. Tap **Start > Programs > ActiveSync**.
3. Tap **Menu > Options**, select **E-mail**, and then tap **Settings**.

4. On the E-mail Sync Options screen:
 - Under **Download size limit**, select the desired email size.
 - Under **Message format**, select **HTML** or **Plain text**.
5. Close ActiveSync and reconnect your device to the computer.

To change the download size and format for POP3/IMAP4 email:

1. Tap **Menu > Options** on the Account Selection screen, or tap **Menu > Tools > Options** while you're in a message list.
2. Tap your email account.
3. Tap **Download Size Settings**.
 - Under **Download size limit**, select the desired email size.
 - Under **Message format**, select **HTML** or **Plain text**.
4. Tap **Done**.

To exclude your email address when replying to all:

When you reply to all the recipients of an email message, your own email address will also be added to the recipient list. You can customize ActiveSync so that your email address will be excluded from the recipient list.

1. In ActiveSync on your device, tap **Menu > Options**.
2. Select the **E-mail** information type and tap **Settings**.
3. Tap **Advanced**:
4. In the **My e-mail addresses** text box, enter your email address.
5. Tap **OK**.

To automatically receive attachments with Outlook email messages:

1. Tap **Start > Programs > ActiveSync**.
2. Tap **Menu > Options**.
3. Tap **E-mail > Settings**, and then select **Include file attachments**.

To automatically receive attachments with IMAP4 email messages:

1. Tap **Start > Programs > Messaging**.
2. Tap **Menu > Options**.
3. Tap the name of your IMAP4 account.
4. Tap **Download Size Settings**.
5. In **Download attachments**, select a download size or select **All attachments**.
6. Tap **Done**.

To store attachments on a storage card:

1. Tap **Start > Programs > Messaging**.
2. Tap **Menu > Tools > Options > Storage** tab.
3. Select the **Store attachments on storage card** check box.

Section 8

Working With Company Email and Meeting Appointments

In This Section

-
- 8.1 Synchronizing Your Device with the Exchange Server
- 8.2 Working With Company Email
- 8.3 Managing Meeting Requests
- 8.4 Finding Contacts in the Company Directory
- 8.5 Email Security
-



8.1 Synchronizing Your Device with the Exchange Server

To keep up-to-date with your company email and meeting schedules while you're out of the office, you can connect your device to the Internet wirelessly and synchronize this information with your company's Exchange Server. You can also access your company address book anytime. Your company must have a mail server that is running Microsoft Exchange Server with Exchange ActiveSync.

Setting Up an Exchange Server Connection

Before you can start to synchronize with or access information from the Exchange Server, you need to set up an Exchange Server connection on your device. You need to get the following information from your network administrator and enter it on your device:

- Exchange Server name (must be the Outlook Web Access server name)
- Domain name
- User name and password that you use at work

If you have not synchronized your device with your PC, follow these steps to set up an Exchange Server connection.

1. Tap **Start > Programs > Messaging > Setup E-mail**.
2. Enter the **E-mail address** and **Password** for the email account and select the **Save password** option. Tap **Next**.
3. Clear the **Try to get e-mail settings automatically from the Internet** option and tap **Next**.
4. In **Your e-mail provider**, select **Exchange server** and tap **Next**.
5. Tap **Next** again.
6. Select the **Attempt to detect Exchange Server Settings automatically** option and tap **Next**.
7. Enter the **Domain name** and tap **Next**.
8. In **Server address**, enter the **Exchange Server address** and tap **Next**.
9. Select the items that you want to sync with the Exchange Server.
10. Tap **Finish**.

Tips:

To change synchronization settings of an information item, for example, **E-mail**, select the item, then tap **Settings**.

To change the rules for resolving synchronization conflicts, tap **Menu > Advanced**.

Notes:

If you synchronized emails with your computer before, open ActiveSync on your device, then tap **Menu > Add Server Source** to set up an Exchange Server connection. When prompted to select information types for synchronization, you must first clear the **E-mail** check box under the Windows PC item before you can select **E-mail** under Exchange Server.

To change Exchange Server settings, open ActiveSync on your device, then tap **Menu > Configure Server**.

Starting Synchronization

Before you start synchronizing with the Exchange Server, make sure your device has been set up with a data connection to the Internet so that you can synchronize wirelessly. For more information about connections, see Section 11.

After you finish setting up an Exchange Server connection, your device automatically starts synchronization.

You can manually start synchronization anytime by tapping **Sync** in ActiveSync.

Note:

If you connect your device to your office computer via a USB or Bluetooth connection, you can use this connection to the PC to “pass through” to the network and download Outlook email and other information to your device.

8.2 Working With Company Email

Your device gives you instant access to your company email and lets you manage your messages more easily. Direct Push, Fetch Mail, Remote email search, and email flags are just some of the tools you can use to manage your email.

Note:

Some messaging features depend on the Microsoft Exchange Server version used in your company. Please check with your network administrator for the availability of these features.

Automatic Synchronization Through Direct Push

Direct Push technology (push email feature) enables you to receive new email on your device as soon as it arrives in your Inbox on the Exchange Server. With this feature, items such as contacts, calendar appointments, and tasks are also immediately updated onto your device when these items have been changed or new entries have been added on the Exchange Server. To make Direct Push work, you need to have a data connection on your device.

You need to perform a full synchronization between your device and the Exchange Server first before Direct Push can be enabled.

Note:

The Direct Push feature works for your device only if your company is using **Microsoft Exchange Server 2003 Service Pack 2 (SP2) with Exchange ActiveSync or higher version.**

To enable Direct Push via Comm Manager:

1. On the Today screen, tap the **Comm Manager** icon (📶).
2. On the Comm Manager screen, tap the **Direct Push** button (✉️).
The button will turn to (✉️); this indicates that you will receive email messages as they arrive.
When the button is in the (✉️) state, you need to manually retrieve your email messages.

To enable Direct Push via ActiveSync:

1. In ActiveSync on your device, tap **Menu > Schedule**.
2. Select **As items arrive** in the **Peak times** and **Off-peak times** boxes.

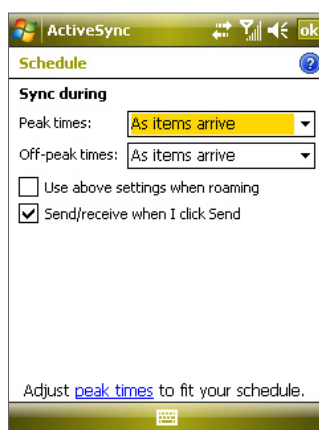
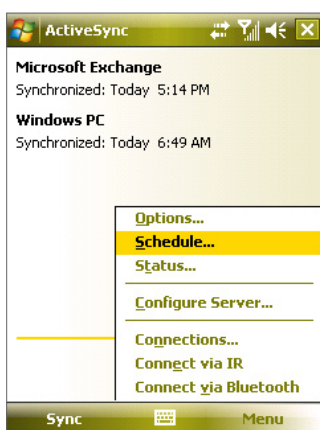

Note:

When the dial-up and Wi-Fi connections are turned on at the same time, the Direct Push feature will always go through the dial-up connection, for which you will be charged for airtime minutes.

Scheduled Synchronization

If you do not want to use Direct Push, you can set a regular schedule for synchronizing Outlook email and information. Set how often to synchronize during peak times (which usually refer to your working hours) when email volume is high, as well as off-peak times when email volume is low.

1. In ActiveSync on your device, tap **Menu > Schedule**.
2. Select a shorter time interval in the **Peak times** box to check for email messages more often during peak times.
3. Select a longer interval in the **Off-peak times** box to check for email messages less often during off-peak times.

Tip:

To set the days and hours that make up your peak and off-peak times, tap **Adjust peak times to fit your schedule**.

Instant Download Through Fetch Mail

The **Fetch Mail** feature downloads an entire email message immediately without the need for you to perform a full Send/Receive action. This limits the download to just the email message that you want and helps save data cost.

Note:

Fetch Mail works for your device only if your company is using **Microsoft Exchange Server 2007** or higher.

1. Tap **Start > Programs > Messaging > Outlook E-mail**.
2. Tap an email message to open it.
3. By default, only the first few kilobytes of the message are shown. To download the whole message, scroll to the bottom of the message, and then tap **Get the rest of this message**.
4. A “Downloading message” notice appears. Wait for the remainder of the message body to be downloaded.

Tip:

For information about changing email sync options such as the initial download size limit for email, see “Customizing Email Settings” in Section 7.

Searching for Email on the Exchange Server

You can access messages that are not available on your device by searching your Microsoft Exchange Server mailbox. The search results will be downloaded and displayed in a Search Results folder.

Note:

Your company must be using **Microsoft Exchange Server 2007** or higher.

1. Tap **Start > Programs > Messaging > Outlook E-mail**.
2. Tap **Menu > Tools > Search Server**.
3. In the **Look for** text box, enter the search keyword.
4. Choose the date range for messages to search.
5. From the **Look in** list, choose whether to search from your inbox or outbox only or to search all folders.
6. Tap **Search**.

The screenshot shows a mobile application dialog box titled "Search Server". The dialog is titled "Criteria for Finding E-mail". It has three dropdown menus: "Look for:" with "sales report" selected, "Date range:" with "Past month" selected, and "Look in:" with "Inbox" selected. There is a checked checkbox for "Include subfolders". At the bottom are "Search" and "Cancel" buttons.

Flagging Your Messages

Flags serve as reminders to yourself to follow up on important issues or requests that are indicated in the messages. Flagging messages, which has been a useful feature on desktop Outlook Email, can also be done in Outlook Mobile on your device. You can flag received messages on your device.

Note:

Flags are enabled only if email messages are synchronized with **Microsoft Exchange Server 2007** or higher. Flags are disabled or hidden if email messages are synchronized with earlier versions of Microsoft Exchange Server.

To flag or unflag a message:

1. Tap **Start > Programs > Messaging > Outlook E-mail**.
2. Select a message, or open a message.
3. Tap **Menu > Follow Up** and select one of the following options:

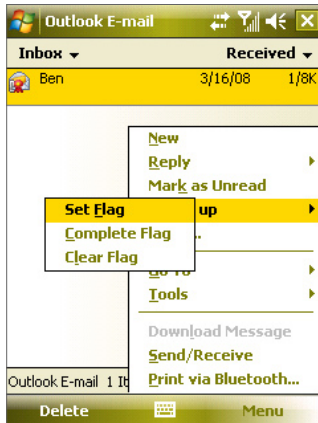

- **Set Flag.** Mark the message with a red flag to indicate that it needs follow-up action.
- **Complete Flag.** Mark the message with a check mark to indicate that the issue or request in the email is already completed.
- **Clear Flag.** Remove the flag to unmark the message.

Note:

Email message reminders are displayed on your device if the messages are flagged with reminders and synchronized from the Exchange Server.

Out-of-Office Auto-reply

Outlook Mobile allows you to retrieve and change your out-of-office status. Just like desktop Outlook Email, Outlook Mobile automatically sends an auto-reply message when you're not available.

To send out-of-office auto-reply messages:

1. Tap **Start > Programs > Messaging > Outlook E-mail**.
2. Tap **Menu > Tools > Out of Office**.
3. From the **I am currently** list, select **Out of the Office**.
4. Enter your auto-reply message and then tap **Done**.

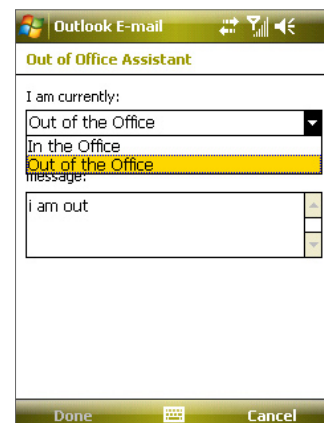

Viewing a Document Linked to an Email Message

When you receive an email message that contains a link to a document such as a PDF or Microsoft Office document located on SharePoint or an internal file server, you can view the document on your device.

Note:

You can view the document only if you have a Microsoft Outlook account that synchronizes with **Microsoft Exchange Server 2007** or later. Exchange Server must also be set up to allow access to SharePoint document libraries or internal file servers.

1. Tap **Start > Programs > Messaging**.
2. Select an email account, and then open a message with a link to a SharePoint document.
3. Tap the link to open and view the document.

8.3 Managing Meeting Requests

When you schedule and send meeting requests from your device, you can invite attendees to your meeting and check their status to know about their availability.

When you receive a meeting request, you can reply by accepting or declining the request. The meeting request also clearly indicates whether or not there are conflicting or adjacent meetings.

Note: Your company must be using **Microsoft Exchange Server 2007** or higher.

To reply to a meeting request:

1. When you receive a meeting request, a notification will be displayed on the Today screen. Open the request.
2. Tap **Accept** to reply and accept the meeting request, or tap **Menu > Decline** if you cannot attend the meeting.

Tips:

Before responding, you can check your availability during the time of the requested meeting by tapping **View your calendar**.

If the time of the meeting conflicts with your other appointments, a “Scheduling Conflict” notice appears at the top of the email.

3. Choose whether to edit your response email before sending and then tap **OK**.

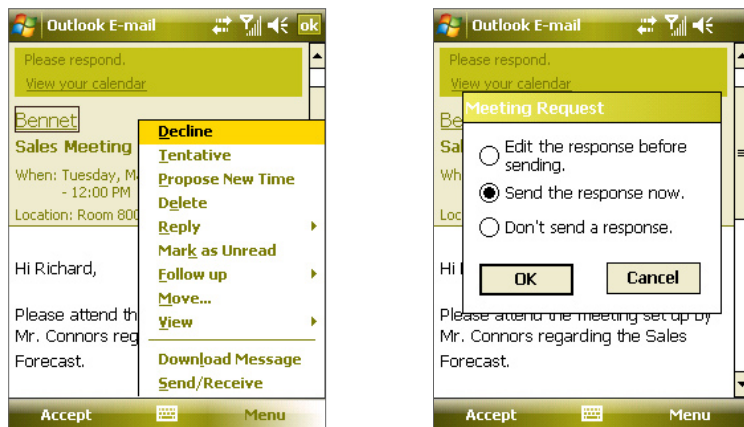

4. If you accepted the meeting request, it will automatically be added as an appointment in Calendar on your device.

To view the list of meeting participants:

1. Tap **Calendar** on the Today screen.
2. Tap a meeting request that you previously sent, and then tap **Attendees**. The list of required and optional attendees will be listed.

Tips:

For information about creating a meeting request, see “To send a meeting request” in Section 6.

If you select a meeting that you have organized, the list shows who has accepted or declined the meeting.

To view an attendee’s contact information, tap the attendee’s name. If the attendee is included in your Contacts list, you will see the contact information immediately. If the attendee is not in your Contacts list, tap **Company Directory** to view the contact information.

8.4 Finding Contacts in the Company Directory

In addition to contacts stored on your device, you can access contact information from your organization's Company Directory. By having over-the-air access to the Company Directory, you can easily send email messages and meeting requests to anyone in your company.

Notes:

Access to the Company Directory is available only if your organization is running **Microsoft Exchange Server 2003 SP2** or higher, and you have completed your first synchronization with the Exchange Server.

1. Synchronize with Exchange Server if you have never done so.
2. Do any of the following:
 - In Contacts, tap **Menu > Company Directory**.
 - In a new email message, tap the **To** box (or tap **Menu > Add Recipient**), and then tap **Company Directory**.

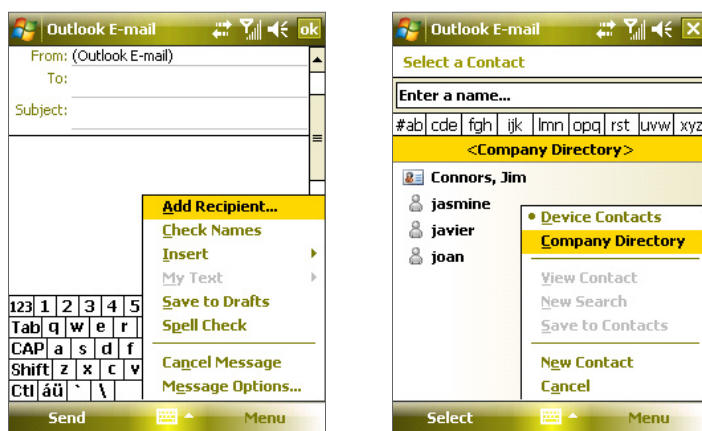

- In a new meeting request using Calendar, tap **Attendees** and then tap **Company Directory** at the top of the list.
3. Enter a partial or full contact name and tap **Search**. In the search results list, tap a contact to select it.

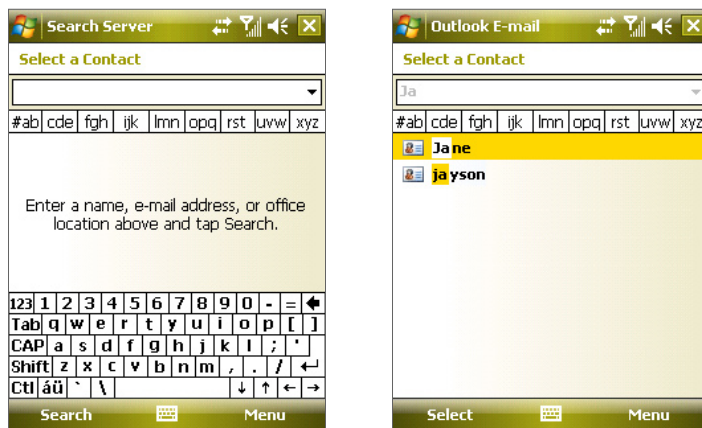

Notes:

You can save a contact from the Company Directory to your device by selecting the contact and then tapping **Menu > Save to Contacts**.

You can search on the following information as long as that information is included in the Company Directory: First name, Last name, Email name, Display name, Email address, or Office location.

8.5 Email Security

Windows Mobile on your device protects your Outlook email through the Secure/Multipurpose Internet Mail Extension (S/MIME), which allows you to digitally sign and encrypt your messages.

Digitally signing a message applies your certificate with the authorization key to the message. This proves to the recipient that the message is from you and not from an imposter or a hacker, and that the message has not been altered.

Encryption protects the privacy of your message by converting it from plain, readable text into cipher (scrambled) text. Only a recipient who has the authorization key can decipher the message.

Notes:

S/MIME encryption and digital signatures for Windows Mobile devices are available only with **Exchange Server 2003 SP2** or a later version that supports S/MIME. If you are not using one of these versions, or have not yet synchronized, these options are unavailable.

You can encrypt a message with or without a certificate. However, to read an encrypted message, you need a valid certificate to decrypt it.

To individually sign and encrypt a new message:

1. Tap **Start > Programs > Messaging > Outlook E-mail**.
2. Tap **Menu > New** to create a new message.
3. Tap **Menu > Message Options**.
4. From the **Security** list, select whether to encrypt only, sign the message only, or both.
5. Tap **OK**.

To verify the digital signature on a signed message you receive:

1. Open the Outlook email message that has been digitally signed.
2. At the top of the message, tap **View Signature Status**.
3. Tap **Menu > Check Certificate**. To view the details of the certificate in the message, tap **Menu > View Certificate**.

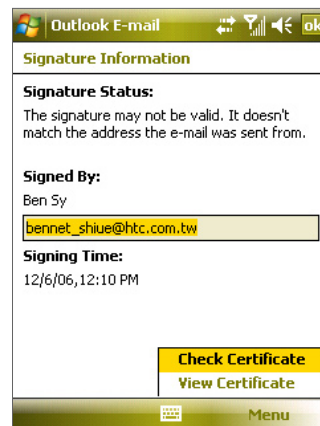
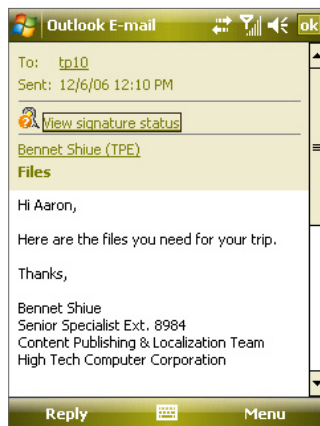

Notes

There can be several reasons why a digital signature is not valid. For example, the sender's certificate may have expired, it may have been revoked by the certificate authority, or the server that verifies the certificate may be unavailable. Contact the sender to report the problem.

To digitally sign and encrypt all messages:

You can set up ActiveSync to digitally sign and encrypt all outgoing messages. You must obtain a valid certificate to sign and encrypt email messages successfully.

1. Tap **Start > Programs > ActiveSync**.
2. Tap **Menu > Options**.
3. Select the **E-mail** information type, and tap **Settings**. On the E-mail Sync Options screen, tap **Advanced**.

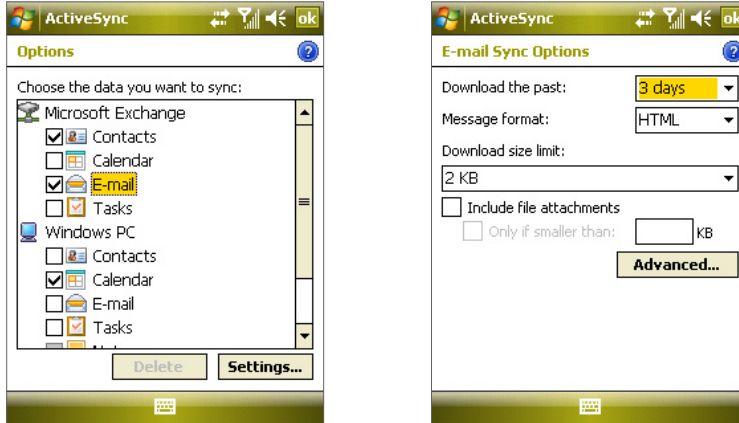

4. Do one or both of the following:
 - To sign all your outgoing email messages so that recipients can be certain that the messages were sent by you and have not been altered in any way, select the **Sign all outgoing e-mail messages** check box.
 - To encrypt all your outgoing email messages so that the contents of your messages are protected from being viewed by anyone other than the intended recipients, select the **Encrypt all outgoing e-mail messages** check box.
5. Tap **Choose Certificate** to select a certificate for signing or encrypting outgoing email messages.

Setting Permissions on an Email Message

Another way of protecting your email messages is to send messages with restricted permissions using Information Rights Management (IRM).

Note: This works only with a Microsoft Outlook email account and if your company is using RMS Server SP1.

1. Tap **Start > Programs > Messaging > Outlook E-mail**.
2. Create a message, and then tap **Menu > Message Options**.
3. In Permissions, do one of the following:
 - To allow anyone to read the message, select **Unrestricted access**.
 - To prevent the message from being forwarded, printed, or copied, select **Do not forward**.
4. Tap **OK**.

Tip: An IRM-protected message received on your device can only be replied to or forwarded if the message permits it.

Section 9

Using Windows Live

In This Section

.....

9.1 Windows Live™

9.2 Live Messenger

9.3 Sending Photos to Your Windows Live Space

.....



9.1 Windows Live™

Windows Live™ gives you the full Internet experience on your device. It helps you to find information, pursue your interests, and get in touch with friends and family on the Internet more easily.

Windows Live offers the following key features:

- **Live Search Bar**, which lets you search for information on the Web.
- **Live Messenger**, the next generation of MSN Messenger Mobile.
- **Live Mail**, the next generation of Hotmail.
- **Live Contacts**, your address book for storing Live Mail, Live Messenger, and Hotmail contacts.

Setting Up Windows Live

The first time you use Windows Live, sign in by using your Windows Live ID, which is your Windows Live Mail or Hotmail address and password.

To set up Windows Live for the first time:

1. Tap **Start > Programs > Windows Live**.
2. Tap **Sign in to Windows Live**.
3. On the next screen, tap the links to read the Windows Live Term of Use and the Microsoft Privacy Statement. After reviewing them, tap **Accept**.
4. Enter your Windows Live Mail or Hotmail address and password, select the **Save password** checkbox, and then tap **Next**.
5. Choose whether to show the Windows Live search bar and applications on the Today screen, and then tap **Next**.
6. Select the information you want to sync online with your device.
7. Tap **Next**.
8. After synchronization is complete, tap **Done**.

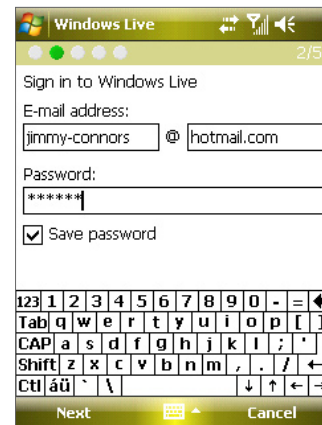

The Windows Live Interface

On the main interface of Windows Live, you will see a search bar, navigation bar, and an area you can customize to show your picture.

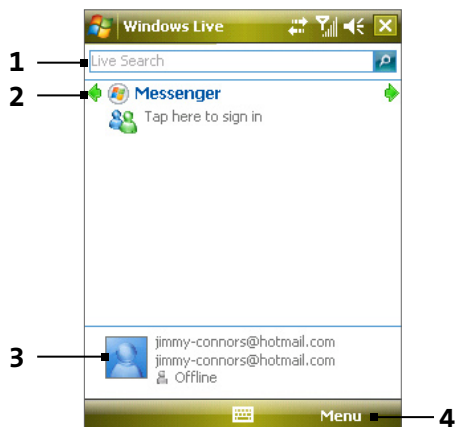

- 1 Live Search Bar.
- 2 Tap the left or right arrow to switch between Windows Live Messenger, Live Mail, and Sync status.
- 3 Tap to access Windows Live Messenger settings.
- 4 Tap **Menu** to access and change settings.

If you chose to display the search bar and Windows Live applications on the Today screen when you were setting up Windows Live, you'll see them on the Today screen:

Live Search Bar and
Windows Live applications

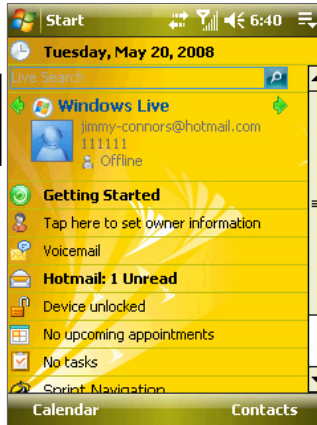

To show or hide this information, open Windows Live and tap **Menu > Options > Today screen options**.

Live Search Bar

Use the **Live Search Bar** to easily find information on the Internet. It is integrated into the Windows Live interface.

To find information on the Internet:

1. Enter your keywords in the search bar.
2. Tap  or **Search**. Internet Explorer Mobile then launches and displays links to related Web sites. The links are organized by category.

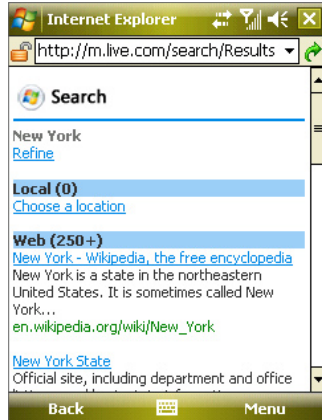

- **Local.** Allows you to perform a local search when you're trying to locate a specific place or street address.
 - **Web.** Shows the results from the Web search, which are links to all related Web sites.
 - **Map.** Shows links to Web sites containing maps.
 - **News.** Shows related links to news articles.
 - **Spaces.** Shows related links to interests, photos, and all kinds of information shared in Windows Live Spaces.
3. Scroll through the categories and tap a link to go to the Web site where the information that you want is located.

9.2 Live Messenger

Live Messenger lets you send and receive instant messages online. With this mobile version of Windows Live Messenger, you enjoy many of the same cool features that you get from the desktop version, which include the following:

- Instant messaging via text and voice
- Multiple conversations
- Ability to add emoticons
- Contact list with presence
- Sending and receiving files including photos
- Ability to change status or display name
- Viewing contacts by online status, groups, and more
- Sending messages even when a contact is offline

Note:

Before you can use Windows Live Messenger Mobile, your device must be connected to the Internet. For information about setting up an Internet connection, see “Connecting to the Internet” in Section 11.

Launching the Messenger and Signing In

To open Windows Live Messenger Mobile:

Do one of the following:

- ▶ Tap **Start > Programs > Messenger**.
- or—
- ▶ On Windows Live or the Today screen, tap the Left or Right arrow until you see **Messenger**, and then tap it.

To sign in and out:

1. To sign in, tap **Sign in** on the messenger screen.
2. If this is your first time signing in, a message appears that your messenger contacts will be added to the Contacts list on your device. Tap **OK** to add them.
(Signing in may take several minutes, depending on your connection speed.)
3. To sign out, tap **Menu > Sign Out**. Your status changes to **Offline**.

Adding Windows Live Contacts

You can add new Windows Live contacts in the messenger or in Contacts.

To add a Windows Live contact in the messenger:

1. Tap **Menu > Add new contact**.
2. Enter the email address of the contact and then tap **OK**.

To add a Windows Live contact in Contacts:

1. Tap **Contacts** on the Today screen.
2. Tap **New** and then tap **Windows Live**.
3. In the **IM** box, enter the email address of the contact, which can be a Windows Live ID or any other email address.

Tip:

You can fill in other information about the contact, if desired. This is not absolutely necessary if you will communicate with the contact only through Windows Live Messenger or Live Mail.

4. Tap **OK**.
5. Follow the remaining instructions to add the new contact to your Windows Live contacts list.

To delete a contact:

1. In the messenger, select the contact and tap **Menu > Contact options > Remove contact**.
2. Choose whether to block the contact.
3. Choose whether to also delete the contact from your device's Contacts list.
4. Tap **OK**.

Sending Instant Messages

You can send instant messages with emoticons, and even talk by sending a voice clip. While chatting, you can send and receive files directly from a message window. You can also start conversations with several contacts and switch between their message screens, or you can invite participants to join in a conversation.

To start and end conversations:

1. In the contacts list, select a contact, and then tap **Send IM** to open a message screen.

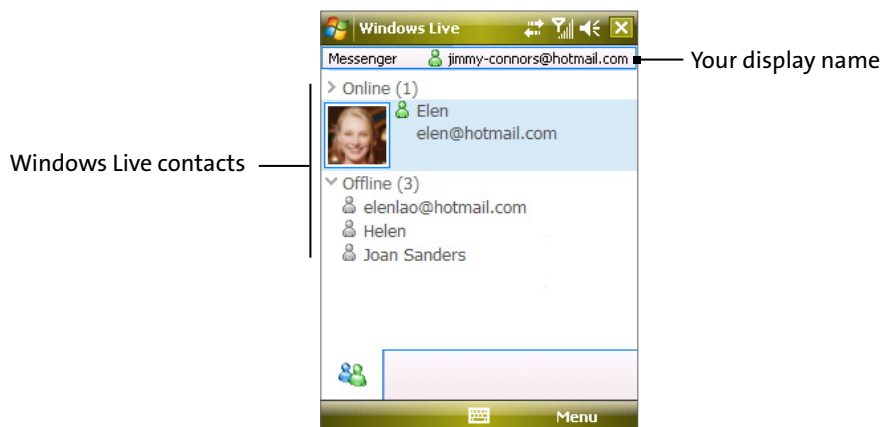

2. Send an instant message. See “To send an instant message with emoticon” on the next page for details.
3. To start a conversation with another contact, tap  to go back to the Contacts list, and then select another contact and tap **Send IM** again. Another message screen opens.
4. To switch from one message screen to another, tap the display picture of the contact you want to talk to.

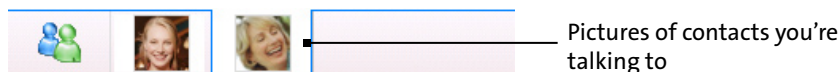

5. To end a conversation with the current contact, tap **Menu > End conversation**.
6. To end all active conversations, tap **Menu > End all conversations**.

To send an instant message with emoticon:

1. Select a contact and start a conversation.
2. Enter your text message in the text entry area of the message screen.
3. To add an emoticon, tap **Menu > Add emoticon** and then tap an icon from the list of emoticons.
4. Tap **Send**.

Tips:

To send a file, tap **Menu > Send**. You can choose to send a picture, voice clip, or any file.

To invite one or more contacts to the conversation, tap **Menu > Options > Add participant**.

To send a voice clip:

1. Select a contact and start a conversation.
2. Tap **Voice clip** and then start talking.
3. After you have spoken a message, tap **Send**.

Personalizing the Messenger

While in the Contacts list, you can do the following:

- Tap **Menu > Change status** to set your current status (such as Busy, Out to lunch, etc.) so that your contacts will know whether you're available.
- Tap **Menu > Change appearance** to change your display name, add a personal message, and add your picture.
- Tap **Menu > Sort by** to organize contacts by online status, groups, name, or email address. You can also hide offline contacts from the Contacts list.
- Tap **Options** to see more settings.

9.3 Sending Photos to Your Windows Live Space

If you created your own live space, you can upload pictures to Spaces.

To upload pictures to your Windows Live Space:

1. Tap **Start > Programs > Pictures & Videos**.
2. Select a picture and then tap **Send to your space**.

Section 10

Working With Documents and Files

In This Section

10.1 Microsoft® Office Mobile

10.2 Adobe Reader LE

10.3 Copying and Managing Files

10.4 Using ZIP



10.1 Microsoft® Office Mobile

Microsoft® Office Mobile consists of the following applications:

- **Microsoft® Office Excel® Mobile** lets you create and edit Excel workbooks and templates on your device.
- **Microsoft® Office OneNote® Mobile** lets you create notes with text, photos, and voice recordings for synchronization later with Microsoft® Office OneNote® 2007 on your computer.
- **Microsoft® Office PowerPoint® Mobile** allows you to view (not create) slide show presentations in *.ppt and *.pps formats.
- **Microsoft® Office Word Mobile** lets you create and edit documents and templates in Word Mobile and save them as *.doc, *.rtf, *.txt, and *.dot files.

To use Microsoft Office Mobile:

1. Tap **Start > Office Mobile**.
2. Tap the Office Mobile application that you want to use.

Word Mobile and Excel Mobile do not fully support some features of Microsoft® Office Word and Microsoft® Office Excel®. To see a complete list of features that are not supported in Word Mobile and Excel Mobile, see Help on your device.

Tips:

By default, Word Mobile saves documents in .docx format, while Excel Mobile saves workbooks in .xlsx format. If you want to open these types of files on a computer that uses Microsoft Office 2000, Office XP, or Office 2003, you need to download and install the File Format Converter in your computer. You can find this converter at <http://www.microsoft.com/downloads/details.aspx?FamilyId=941B3470-3AE9-4AEE-8F43-C6BB74CD1466&displaylang=en>.

If you want Word Mobile to save documents in .doc format, tap **Menu > Tools > Options** (or **Menu > Options** when no document is opened), then change the **Default template** to **Word 97-2003 Document (.doc)**.

If you want Excel Mobile to save workbooks in a format that is compatible with Microsoft Office 2000, Office XP, or Office 2003, tap **Menu > Options** (with no workbook opened), then change the **Template for new workbook** to **Blank 97-2003 Workbook**.

10.2 Adobe Reader LE

Adobe Reader LE allows you to open and view Portable Document Format (PDF) files. These files usually have a *.pdf file extension.

To open a PDF file on your device:

1. Tap **Start > Programs > Adobe Reader LE**.
2. Tap **Open**.
3. Browse to a folder and tap the PDF file you want to view.

Note:

To open another PDF file, tap **Menu > Open**. Tap **Browse**, select the desired file, and tap **Open**. You can also open a PDF file from File Explorer.

To navigate through a PDF file:

You can do any of the following:

- ▶ Tap the Up, Down, Right, and Left arrow keys on the horizontal and vertical scrollbars to move to the desired direction of the page.
- ▶ Press the Navigation Control up, down, right, and left to move up or down a page or scroll through the pages.
- ▶ Tap the space between the arrow keys and the scrollbar with your stylus to move one screen towards the desired position.
- ▶ Tap and drag the scrollbar tab to quickly scroll through pages and jump to a desired page number.
- ▶ Tap **Tools > Go To** and select an option to go to a specific page in a multi-page PDF file.

To enlarge or reduce the display size:

1. Open a PDF file you want to view.
2. Tap **Tools > Zoom**.
3. Select **In** or **Out** to enlarge or reduce the display size. Otherwise, select **Fit Screen** or **Fit Width**.
4. Select **To %** to set a custom zoom ratio.

To customize page view and orientation:

1. Open a PDF file you want to view.
2. Tap **Tools > View**.
3. Select an option to suit your view.









To find text in a PDF file:

1. Open a PDF file you want to view.
2. Tap **Tools > Find > Text**.
3. Enter the text to be searched.
4. Choose search parameters, such as **Match case**, **Whole word**, or **Backwards**, and tap **Find**.

Note:	<p>Adobe Reader LE offers you the following advanced features.</p> <ul style="list-style-type: none">■ It displays a bookmark pane for the PDF files that contain bookmarks. Tap the bookmarks to go to a specific section or page within the file.■ It supports password-protected PDF files with up to 128-bit encryption. When you open a password-protected PDF file, you will be prompted to enter the password before the file can be opened.
--------------	--

To use the toolbar:

You can also use the Adobe Reader LE toolbar to access the most commonly used functions. The following table lists the toolbar controls.

This Control	Does This
	Fits the page height to the screen
	Fits the page width to the screen
	Displays the first page
	Displays the previous page
	Displays the next page
	Displays the last page
	Displays the text search screen
	Zooms out
	Zooms in

10.3 Copying and Managing Files

You can copy files between your device and your PC using Windows Mobile Device Center or ActiveSync, or copy files to a storage card that is inserted in your device. You can also efficiently manage your files and folders using File Explorer.

Copying Files Using Windows Mobile Device Center or ActiveSync

Using Windows Mobile Device Center or ActiveSync, you can copy files from your PC to your device and vice versa.

To copy a file between your device and the PC:

1. Connect your device to the PC.
2. Click **File Management > Browse the contents of your device** in Windows Mobile Device Center or click **Explore** in ActiveSync on your PC. This opens the Mobile Device folder for your device.
3. To copy a file from your device to your PC:
 - a. In Windows Explorer on your PC, browse your device and navigate to the file that you want to copy.
 - b. Right-click the file, and then click **Copy**.
 - c. Locate the destination folder on your PC. Right-click the folder, and then click **Paste**.
4. To copy a file from your PC to your device:
 - a. On your PC, navigate to the folder that contains the file you want to copy.
 - b. Right-click the file, and then click **Copy**.
 - c. Right-click the destination folder on your device, and then click **Paste**.

Copying a file results in separate versions of a file on your device and PC. Because the files are not synchronized, changes made to one file will not affect the other. If you want file changes to be automatically updated on your device and PC, you can synchronize files between your device and PC. For more information about synchronizing with a computer, see Section 5.

Using File Explorer

File Explorer lets you browse the contents of folders on your device. The root folder on the device is named **My Device**. **My Device** is similar to **My Computer** on the PC and contains the **My Documents**, **Program Files**, **Temp**, **Storage Card**, and **Windows** folders, among others.

To use File Explorer:

1. Tap **Start > Programs > File Explorer**.
2. Tap a folder or file to open it.
3. To return to an upper level folder, tap the Down arrow (▼) and select the folder.
4. To delete, rename, or copy a file quickly, tap and hold the file and then choose the desired operation from the shortcut menu. To select multiple files, tap and drag over the desired files.

Copying Files to a Storage Card

To copy files to a storage card:

1. Make sure the storage card is properly inserted in your device.
2. Tap **Start > Programs > File Explorer** and navigate to the appropriate folder.
3. Tap and hold the file you want to copy, and tap **Copy**.
4. Tap the Down arrow (▼) and then tap **Storage Card** from the list.
5. Tap **Menu > Edit > Paste**.

To automatically save files to a storage card:

In the Word Mobile, Excel Mobile, and Notes programs, you may find it helpful to save all new documents, notes, and workbooks directly to a storage card.

1. From the program file list, tap **Menu > Options**.
2. With a storage card inserted in your device, in the **Save to** box, select the appropriate storage card to which you wish to automatically save new files.
3. Tap **OK**.

Note:

In the file or note list, a storage card symbol () is displayed next to the names of files saved on a storage card.

10.4 Using ZIP

ZIP allows you to save memory and increase the storage capacity of your device by compressing files in the conventional ZIP format. You can view and extract archive files received from various sources. You can also create new *.zip files on your device.

Starting ZIP and Opening .zip Files

You can use ZIP to either archive files or to open an existing archive file on your device. Each time you start ZIP on your device, it searches for files that have the .zip file extension and displays these files on the Archive List screen.

To start ZIP on your device:

- ▶ Tap **Start > Programs > ZIP**.

To open a ZIP file and extract files

1. Open a file by doing one of the following:
 - Select a file and tap **File > Open Archive**.
 - Tap and hold a file and tap **Open Archive**.
 - Double-tap a file.

Note: You cannot select multiple ZIP files.

2. The files contained in the zip file are then displayed. Select files by doing one of the following:
 - Tap to select a file.
 - To select several files, tap **Menu > Action** and make sure **Multi-Select Mode** is selected. Select files by tapping each file. (Tap a selected file to deselect it.)
 - To select all files, tap **Menu > Action > Select All**.
3. Tap **Menu > Action > Extract**.
4. Choose a folder to which files will be extracted, and then tap **Extract**.

To create a zip archive:

1. Tap **New** or **File > New Archive**.
2. On the Save As screen, enter a zip file name and choose a folder to which to save the zip file. You can also choose whether the zip file will be saved on the device's main memory or a storage card.
3. Tap **Save**.
4. Tap **Menu > Action > Add**.
5. Double-tap the folder that contains the files you want to archive.
6. Select files by doing one of the following:
 - Tap to select a file.
 - To select several files, tap and hold on the screen, and then select **Multi-Select Mode**. Select files by tapping each file. (Tap a selected file to deselect it.)
 - To select all files, tap and hold on the screen, and then tap **Select All**.
7. Tap **Add**.
8. Tap **Menu > File > Close Archive**.
9. After closing the zip file, you can tap **Find** or **Menu > File > Find Archive** to search for all zip files and display them on the Archive List screen.

Section 11

Getting Connected

In This Section

11.1 Comm Manager

11.2 Connecting to the Internet

11.3 Internet Explorer Mobile

11.4 Using Bluetooth

11.5 Using Your Device as a Modem (Internet Sharing)



11.1 Comm Manager

Comm Manager acts as a central switcher that lets you enable or disable phone features as well as manage your data connections easily.

To open Comm Manager:

- ▶ Tap the **Comm Manager** icon () on the Today screen.

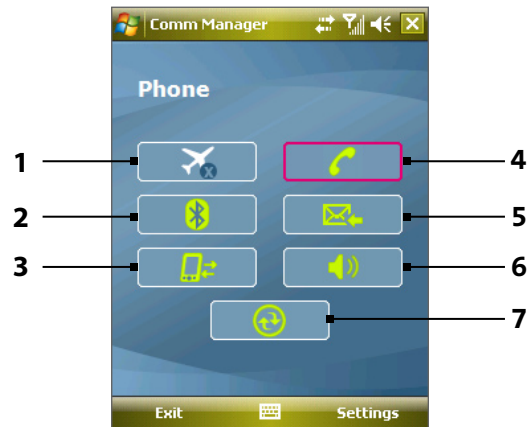

1. Tap to toggle Flight mode on or off. Turning Flight mode on turns off the phone, Bluetooth, and WLAN functions.
2. Tap to toggle Bluetooth on or off. Tap **Settings > Bluetooth** to configure Bluetooth on your device.
3. Tap to disconnect active data connections. You cannot reconnect data connections in Comm Manager.
4. Tap to toggle between enabling or disabling the phone function. Tap **Settings > Phone** to customize phone settings.
5. Tap to toggle between automatically receiving (as items arrive) or manually retrieving Outlook email.
6. Tap to toggle between turning on the phone's ringer or setting the phone to vibration/mute mode.
7. Tap to open ActiveSync so you can synchronize the device and computer.

11.2 Connecting to the Internet

Your device is equipped with powerful networking functions that enable you to connect to the Internet.

Ways of Connecting to the Internet

Your device's networking capabilities allow you to access the Internet or your corporate network at work through wireless and conventional connections. You can connect to the Internet through one of the following connections:

- Wi-Fi
- Dial-up
- Work connections, such as Virtual Private Network (VPN) and proxy connections

Wi-Fi

Wi-Fi provides wireless Internet access over distances of up to about 300 feet. To use Wi-Fi on your device, you need access to a wireless access point of your service provider. When you are in public places, such as in a coffee shop or restaurant, you will need access to the public wireless access points (also referred to as "hotspots" for such places).

Note:

The availability and range of your device's Wi-Fi signal depends on the infrastructure and other objects through which the signal passes.

To turn Wi-Fi on or off:

- ▶ At the lower left side of your device, slide the WLAN switch upward. The icons on the switch represent the following:

 : Wi-Fi is turned on.

 : Wi-Fi is turned off.

To connect to a wireless network

1. After Wi-Fi has been turned on, your device then scans for available wireless networks in your area. The network names of the detected wireless networks will be displayed in a pop-up message window. Tap a wireless LAN, and then tap **OK**.



2. In the next pop-up message window, tap **The Internet** if the wireless LAN connects your device to the Internet, or tap **Work** if the wireless LAN connects your device to a private network.

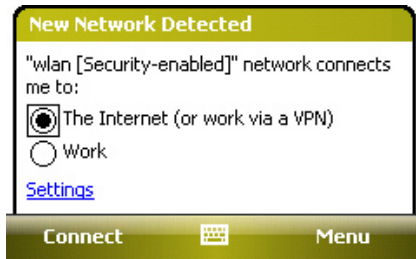

3. If the wireless LAN is secured by a network key, enter the key, and then tap **Connect**.

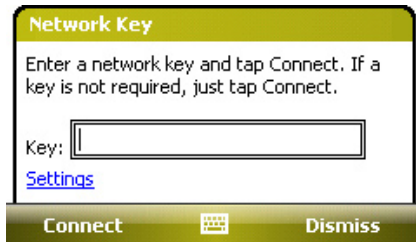

The next time you use your device to detect wireless networks, you will not see the pop-up message windows, and you will not be prompted to enter the network key of the previously accessed wireless network (unless you perform a hard reset, which will erase custom settings on your device).

Note:

Wi-Fi networks are self-discoverable, which means no additional steps are required for your device to connect to a Wi-Fi network. However, it may be necessary to provide a user name and password for certain closed wireless networks.

To save battery power while connected to a wireless network:

1. Tap **Start > Settings > Connections tab > Wireless LAN** to open the Wireless LAN Settings screen.
2. On the **Power Mode** tab of the Wireless LAN Settings screen, move the **Power Save Mode** slider to a position that optimizes performance with the least power consumption.

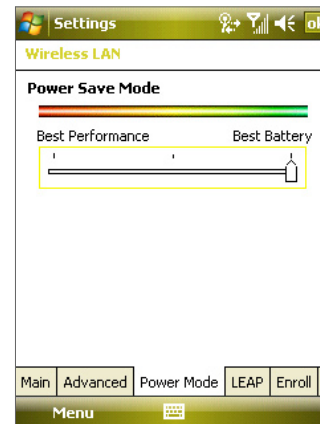

For example, move the slider to the left (Best Performance) to have the optimal WLAN performance; move to the right (Best Battery) to obtain the maximum battery usage.

3. You can also select the **Auto turn off WLAN if not connected** check box to allow your device to turn off the WLAN function automatically when no signal is detected.



To check the wireless LAN status:

You can check the current wireless connection status from any of the following screens on your device:

- **Title bar.** When you enable Wi-Fi on your device, the Wi-Fi ON icon () will appear on the title bar. After Wi-Fi is turned on, your device scans for available wireless networks and the wireless signal icon () appears on the title bar. The arrows in this icon will move back and forth while your device is scanning for a wireless LAN signal. Once your device successfully connects to a wireless LAN, the arrows stop moving.

- **Wireless LAN screen - Main tab.** This screen displays the name of the wireless network that your device is currently connected to. The configuration and signal quality of the wireless network are also shown.
- **Configure Wireless Networks screen.** Tap **Start > Settings > Connections tab > Wi-Fi > Wireless tab.** This screen displays the wireless networks currently available.

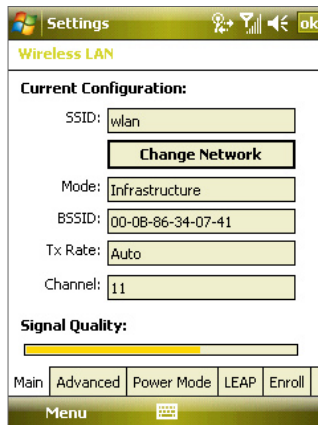

Wireless LAN: Main tab

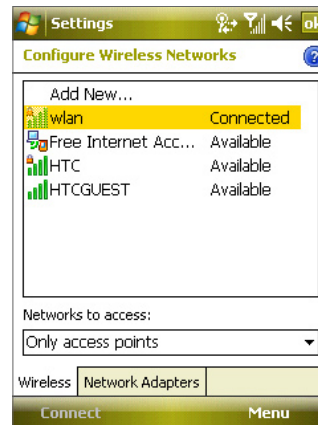

Wi-Fi: Wireless tab

- To connect to a wireless network in the list, tap and hold on the desired network, and then tap **Connect**.
- Tap a wireless network in the list to view or change its connection settings.
- You can also add new wireless networks, if available, by tapping **Add New**.

Notes:

To increase security, tap the **LEAP** tab and then tap **New** and create a LEAP profile for authenticating access to the wireless network.

For LEAP to work correctly, both the access point and the receiving device (your device) must be set with the same SSID, user name, and password.

Dial-up

In times when you are not within the coverage of a wireless network, use the 1XRTT or EVDO dial-up connection on your device to connect to the Internet or your corporate network. Your device has two groups of connection settings: **Sprint** and **My Work Network**. The **Sprint** settings are used to connect to the Internet, while **My Work Network** settings can be used to connect to any private or corporate network. Simply fill in the settings and you'll be ready to start connecting.

To connect to the Internet via Sprint:

1. Obtain the following information from Sprint:
 - ISP server phone number.
 - User name.
 - Password.
2. Tap **Start > Settings > Connections tab > Connections**.
3. Tap **Add a new modem connection**.
4. Enter a name for the connection, and then select a modem from the list box.
For example, if you want to use the mobile phone network, select **Cellular Line**.
5. Tap **Next**.
6. Complete the connection wizard by entering the required information, and then tap **Finish**.

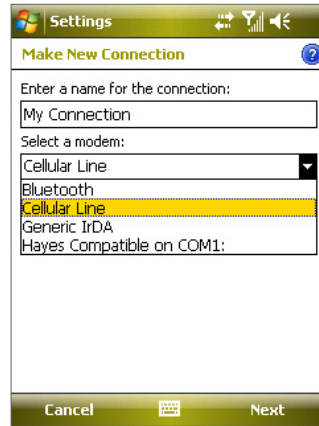
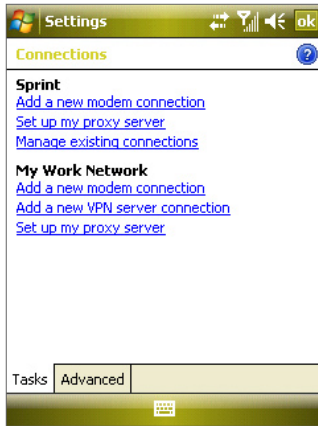

Tips: To view additional information for any screen, tap the **Help** icon (?).
To modify your connection settings, tap **Manage existing connections** on the Connections screen, and complete the connection wizard.

Work Network Connections

A Virtual Private Network (VPN) connection allows you to access your company network through your device's Internet connection, whereas a proxy connection lets you access the Internet using an existing connection to your corporate or WAP network.

To connect to a private network:

1. Obtain the following information from your network administrator:
 - Server phone number.
 - User name and password.
 - Domain (provided by the network administrator).
2. Tap **Start > Settings > Connections tab > Connections**.
3. In **My Work Network**, follow the instructions for each type of connection.
4. Complete the connection wizard, and then tap **Finish**.

Starting a Data Connection

After a data connection has been set up on your device, you can then connect your device to the Internet. The connection is started automatically when you begin using a program that requires an Internet connection. For example, when you start Internet Explorer Mobile to browse the Internet, your device connects automatically.

To manually start a data connection:

1. Tap **Start > Settings > Connections tab > Connections**.
2. Tap **Manage existing connections**.
3. Tap and hold the name of the desired connection, and then tap **Connect**.

To disconnect a data connection:

- ▶ On the Comm Manager screen, tap the **Data Connection** button ().

11.3 Internet Explorer Mobile

Internet Explorer Mobile is a full-featured Internet browser that is optimized for use on your device.

To start Internet Explorer Mobile:

- ▶ Tap Start > Internet Explorer.

To go to a Web site:

- ▶ Enter the Web site address in the Address Bar, then tap .

Internet Explorer® menu

While browsing the Web, tap **Menu** to choose from a list of options, such as saving Favorites, changing the viewing size, and more. You can also tap and hold on a Web page to choose options from the shortcut menu.

Tip: For more information about using Internet Explorer® Mobile, please go to: <http://www.microsoft.com/windowsmobile/help/pocketpc/browseinternet.msp>.

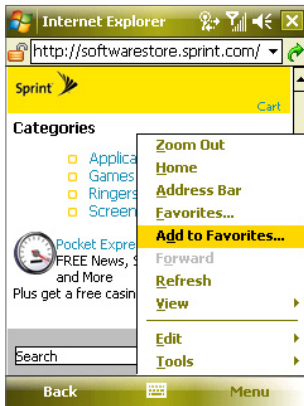

Tap **Menu > Add to Favorites** to save the current Web page in your Favorites folder.

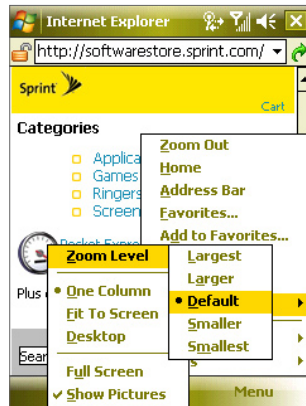

Tap **Menu > View > Zoom Level** to select the select a zoom level.

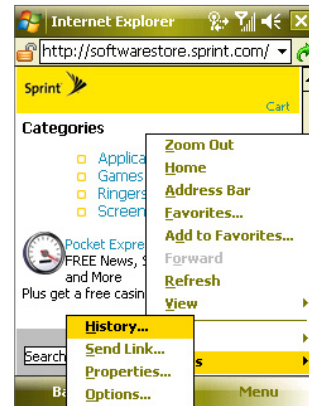

Tap **Menu > Tools** and choose to send the current Web page link, view the page's properties, or set preferences.

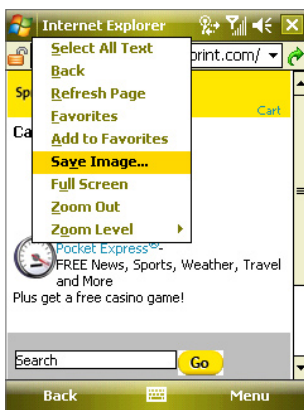

To save an image from a Web page to your device, tap and hold the image then tap **Save Image**.

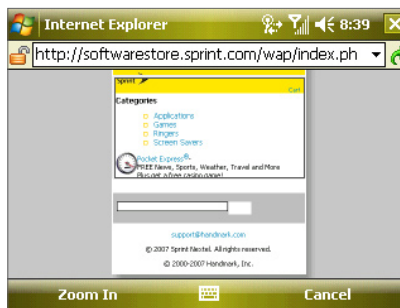

To navigating large-sized Web pages, tap **Menu > Zoom Out**. Use the Navigation Control to move the box to the area of the Web page you want to view, and then tap **Zoom In** or press the ENTER button.

11.4 Using Bluetooth

Bluetooth is a short-range wireless communications technology. Devices with Bluetooth capabilities can exchange information over a distance of up to about 33 feet without requiring a physical connection. You can even beam information to a device in a different room, as long as it is within the Bluetooth signal coverage range.

Bluetooth can be used in the following ways:

- ▶ To beam information, such as files, appointments, tasks, and contact cards between devices that have Bluetooth capabilities.
- ▶ To synchronize information between your device and computer via Bluetooth.
- ▶ To use a Bluetooth-enabled headset (or other Bluetooth-enabled hands-free device such as a car kit) with your device for hands-free phone conversations.
- ▶ To use a Bluetooth service. Once you connect to another device or computer using Bluetooth, you can locate and use any of the services available on that device.
- ▶ To create a connection between your device and another Bluetooth-enabled phone to use that phone as a modem.

Bluetooth Modes

Bluetooth on your device operates in three different modes:

- **On.** Bluetooth is turned on. Your device can detect other Bluetooth-enabled devices, but cannot be detected by those devices.
- **Off.** Bluetooth is turned off. In this mode, you can neither send nor receive information using Bluetooth. You might want to turn Bluetooth off at times in order to conserve battery power, or in situations where using a wireless device is prohibited, such as onboard an aircraft and in hospitals.
- **Visible.** Bluetooth is turned on, and all other Bluetooth-enabled devices can detect your device.

Note:

By default, Bluetooth is turned off. If you turn it on, and then turn off your device, Bluetooth also turns off. When you turn on your device again, Bluetooth automatically turns on.

To turn Bluetooth on and make your device visible:

1. On your device, tap **Start > Settings > Connections tab > Bluetooth**.
2. From the **Mode** tab, select the **Turn on Bluetooth** and **Make this device visible to other devices** check boxes.
3. Tap **OK**.

Bluetooth Partnerships

A Bluetooth partnership is a relationship that you create between your device and another Bluetooth-enabled device in order to exchange information in a secure manner. Creating a partnership between two devices involves entering the same Bluetooth passcode on both devices.

Creating a partnership between two devices is a one-time process. Once a partnership is created, the devices can recognize the partnership and exchange information without entering a passcode again. Make sure Bluetooth is turned on and in visible mode on the two devices.

To create a Bluetooth partnership:

1. On your device, tap **Start > Settings > Connections** tab > **Bluetooth**.
2. On the **Devices** tab, tap **Add new device**. Your device will search for other Bluetooth devices and display them in the box.
3. Tap a device name in the box.
4. Tap **Next**.
5. Enter a passcode to establish a secure connection. The passcode can be from 1 to 16 characters long.
6. Tap **Next**.
7. Wait for the paired device to accept the partnership. The receiving party needs to enter the same passcode that you specified.
8. The name of the paired device is then displayed. You may edit and enter a new name for that device.
9. Select the check boxes of services that you want to use from the paired device.
10. Tap **Finish**.

To accept a Bluetooth partnership:

1. Ensure that Bluetooth is turned on and in visible mode.
2. Tap **Yes** when prompted to establish a partnership with the other device.
3. Enter a passcode (the same passcode that is entered on the device requesting the partnership) to establish a secure connection. The passcode must be from 1 to 16 characters long.
4. Tap **Next**, and then **Finish**. You can now exchange information with the other device.

To rename a Bluetooth partnership:

1. Tap **Start > Settings > Connections** tab > **Bluetooth**.
2. Tap and hold the partnership on the **Devices** tab.
3. On the shortcut menu, tap **Edit**.
4. Enter a new name for the partnership.
5. Tap **Save**.

To delete a Bluetooth partnership:

1. Tap **Start > Settings > Connections** tab > **Bluetooth**.
2. Tap and hold the partnership on the **Devices** tab.
3. On the shortcut menu, tap **Delete**.

Connecting a Bluetooth Hands-free or Stereo Headset

For hands-free phone conversations, you can use a Bluetooth hands-free headset such as a car kit with your device. Your device also supports A2DP (Advanced Audio Distribution Profile) which allows you to use a Bluetooth stereo headset for hands-free phone conversations and for listening to stereo music.

To connect a Bluetooth hands-free or stereo headset:

1. Make sure that both your device and the Bluetooth headset are turned on and within close range, and that the headset is visible. Refer to the manufacturer's documentation to find out how to set the headset in visible mode.
2. Tap **Start > Settings > Connections** tab.
3. Tap **Bluetooth > Devices** tab > **Add new device**. Your device displays the names of other Bluetooth devices within range.
4. Tap the name of the Bluetooth headset, then tap **Next**. The device will automatically pair with the Bluetooth headset.

Windows Mobile will automatically try one of the preconfigured passcodes (0000, 1111, 8888, 1234) to pair the Bluetooth headset with the device. If this fails, you have to enter the passcode delivered with your headset manually.

5. Tap **Done**, then tap the Bluetooth headset name in the **Devices** tab.
6. Select the **Hands Free** check box. If you have connected a Bluetooth stereo headset, also select the **Wireless Stereo** checkbox.
7. Tap **Save**. While the Bluetooth stereo headset is connected, the **Headset** icon (🎧) will appear on the title bar.

Note:

If the Bluetooth stereo headset becomes disconnected, turn the headset on and repeat steps 1 to 3 above. Tap and hold the name of the Bluetooth stereo headset and tap **Set as Wireless Stereo**.

Beaming Information Using Bluetooth

You can beam information, such as contacts, calendar items, tasks, and files from your device to your computer or to another Bluetooth-enabled device.

Note:

If your computer does not have built-in Bluetooth capability, you need to connect and use a Bluetooth adapter or dongle on your computer.

To beam information from your device to a computer:

1. Turn on Bluetooth on your device, and make your device visible. For information about this, see "To turn Bluetooth on and make your device visible" in this section.
2. You also need to set Bluetooth on your computer to visible mode. Do one of the following:
 - If your computer has Windows XP SP2 and your computer's built-in or external Bluetooth adapter is supported by Windows XP SP2, open **Bluetooth Devices** from the Control Panel. Click the **Options** tab, and then select the **Turn discovery on** and the **Allow Bluetooth devices to connect to this computer** options.
 - If the Bluetooth adapter on your computer was installed using a third-party provided driver, open the Bluetooth software that came with the Bluetooth adapter. This software varies by manufacturer, but in most cases, you will find a **Bluetooth Configuration** utility which you can open from the Control Panel. After Bluetooth Configuration opens, click the **Accessibility** tab, and then select **Let other Bluetooth devices to discover this computer**. Refer to the Bluetooth adapter's documentation for more information.

3. Create a Bluetooth partnership between the two devices. For information about creating a partnership, see “Bluetooth partnerships.” After a partnership has been created successfully, your computer is ready to receive Bluetooth beams.
4. On your device tap and hold an item to beam. The item can be an appointment in your calendar, a task, a contact card, or a file.
5. To beam a contact, tap **Menu > Send Contact > Beam**. To beam other types of information, tap **Menu > Beam [type of item]**.
6. Tap the device name to which you want to send the beam.
7. If you beamed an Outlook item and it is not automatically added to Outlook, select **File > Import and Export** in Outlook to import it.

To beam information to a Bluetooth-enabled device such as another smart device, follow steps 3 to 6 in the above procedure.

Note:

If the device you want to beam to does not appear in the box, make sure that it is turned on and visible.

To receive a Bluetooth beam:

Your device will not detect and notify you of incoming Bluetooth beams unless you set it up to do this.

1. Tap **Start > Settings > Connections tab > Beam**.
2. Select the **Receive all incoming beams** check box.
3. Make sure your device is turned on, visible, and within Bluetooth range of the device that is beaming the information.
4. When prompted to receive an incoming beam, tap **Yes** to receive the beamed information.

Tip:

Selecting the **Receive all incoming beams** check box also allows the device to detect and receive infrared beams.

11.5 Using Your Device as a Modem (Internet Sharing)

Internet Sharing connects your PC or notebook computer to the Internet by using your device's data connection. You can choose to connect via USB or Bluetooth.

Note:

Sprint requires customers to have a separate Phone As Modem service plan in order to use this device as a modem. More information about Phone As Modem service plans are available at www.sprint.com, or you can contact Sprint Customer Service to add the Phone as Modem service plan to your account.

Follow the procedure below to set up your device as a USB modem. To learn how to set up your device as a Bluetooth modem, see "To use your device as a Bluetooth modem."

Notes:

Make sure you have subscribed to a Phone As Modem Service plan and have set up a phone dial-up modem connection on your device. If your device has not been set up with a data connection yet, tap **Menu > Connection Settings** on the Internet Sharing screen.

If you want to use a USB Sync cable connection, you must first install Microsoft ActiveSync version 4.5 or later on the computer.

If you want to use a Bluetooth connection, make sure your computer has built-in Bluetooth capability. If your computer does not have Bluetooth, you can connect and use a Bluetooth adapter or dongle on your computer.

Before using Internet Sharing, disable ActiveSync on your computer.

To set up your device as a USB modem:

1. On your device, tap **Start > Programs > Internet Sharing**.
2. In the **PC Connection** list, select **USB**.

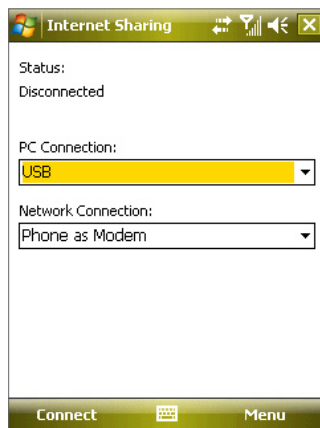

3. In the **Network Connection** list, select the name of the connection that your device uses to connect to the Internet.
4. Plug in the USB Sync cable between your device and the computer.
5. Tap **Connect**.

To use your device as a Bluetooth modem:

For the computer to use the Internet connection of your device, activate Internet Sharing on your device, and then set up a Bluetooth Personal Area Network (PAN) between the computer and your device.

1. On your device, turn on Bluetooth and set it to visible mode.
2. Initiate a Bluetooth partnership from your device by following the steps in "To create a Bluetooth partnership" in this section.
3. Tap **Start > Programs > Internet Sharing**.

4. Select **Bluetooth PAN** as the **PC Connection**.
5. From the **Network Connection** list, select the name of the connection that your device uses to connect to the Internet.
6. Tap **Connect**.
7. On your computer, set up a Bluetooth Personal Area Network (PAN) with your device:

For Windows Vista:

- a. Click **Start > Control Panel > Network and Internet > Network and Sharing Center**.
- b. Click **Manage network connections** and then under **Personal Area Network**, double-click **Bluetooth Network Connection**.
- c. In the **Bluetooth Personal Area Network Devices** dialog box, select your phone, and then click **Connect**.

For Windows XP:

- a. Tap **Start > Control Panel > Network Connections**.
 - b. Under **Personal Area Network**, click the **Bluetooth Network Connection** icon.
 - c. Under **Network Tasks**, click **View Bluetooth network devices**.
 - d. In the **Bluetooth Personal Area Network Devices** dialog box, select your device, and then click **Connect**.
8. On the Internet Sharing screen on your device, check that a connected message is displayed, indicating that your computer has been successfully connected to the Internet using your device as a Bluetooth modem.

To end the Internet connection:

- ▶ On the Internet Sharing screen, tap **Disconnect**.

Section 12

Experiencing Multimedia

In This Section

.....
12.1 Using the Built-in Camera

12.2 Using Pictures & Videos

12.3 Using Windows Media Player
.....



12.1 Using the Built-in Camera

Taking photos and capturing video clips along with audio is easy with the built-in camera on your device.

To open the Camera screen:

- ▶ Press and hold the Camera Key on your device.
— or —
- ▶ Tap **Start** > **Programs** > **Camera**.
— or —
- ▶ Tap **Start** > **Programs** > **Pictures & Videos** > **Camera** icon.

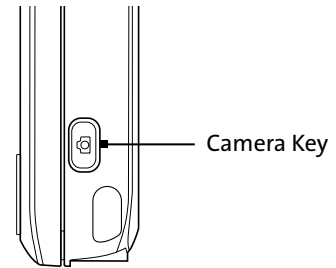



To exit the Camera:

- ▶ Tap the Exit icon ().

Capture Modes

The camera on your device allows you to capture pictures and video clips by using various built-in modes with flexibility. The camera is set to the Photo capture mode by default. The upper left corner of the screen displays the active capture mode. To switch to other capture modes, do either of the following:

- ▶ Tap  or  on the screen.
- ▶ Press the Navigation Control left or right.

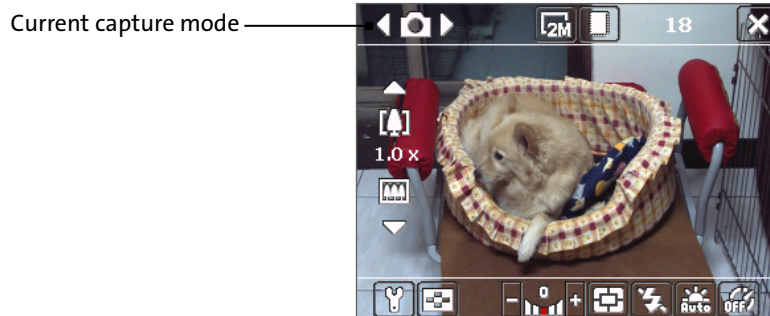

The available capture modes of the camera are as follows:

- **Photo** to capture standard still images.
- **Video** to capture video clips, with or without accompanying audio.
- **Contacts Picture** to capture a still image with the option to immediately assign it as a Photo ID for a contact.
- **Picture Theme** to capture still images and place them within frames.
- **Panorama** to capture a sequence of still images continuously in one direction, and allow stitching of all the images to create a panoramic view of a scene.
- **Sports** to capture a sequence of still images (3, 5, 7, or 10) automatically.
- **Burst** to capture a sequence of still images (maximum 30) as long as the Camera Key on the device or the ENTER button on the Navigation Control remains pressed.

Supported File Formats

The camera in your device captures files in the following formats:

Capture type	Format
Still image	JPEG
Video	MPEG-4 (.mp4) Motion-JPEG (.avi) H.263 (.3gp) 3GP2 (.3g2)
Panorama / Sports / Burst	JPEG

Camera Controls

Use the following device buttons and onscreen controls to take photos or video clips and to modify settings.

The Camera Key, ENTER button, and Jog Wheel

The Camera Key, ENTER button, and Jog Wheel can all be used as the shutter release.

- ▶ Press to take a photo or to take shots for a picture theme or panorama.
- ▶ Press to start recording video; press again to stop recording.
- ▶ To take consecutive shots in Sports mode, press the Camera Key briefly, and then move your device to follow the movement of your subject.
- ▶ Press and hold when taking consecutive shots in Burst mode.







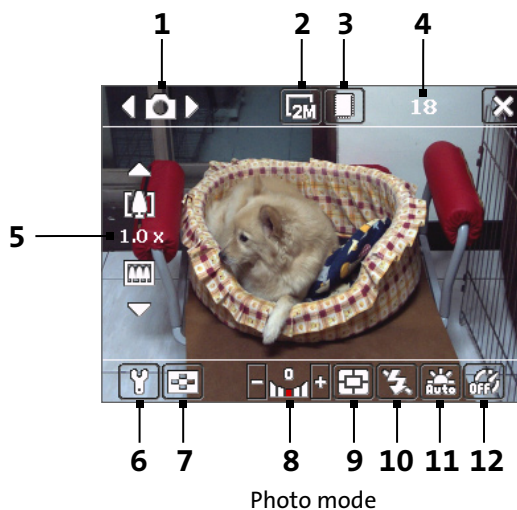









The Navigation Control

- ▶ Press the Navigation Control up or down to increase or decrease the zoom level.
- ▶ Press the Navigation Control left or right to go to the previous or next sequential capture mode.

Onscreen controls and indicators



- 1 Mode Switching control.** Tapping the left/right arrow (◀/▶) on the screen allows you to switch the capture mode.
- 2 Resolution.** The resolution icon (📷/📷/📷/📷/📷) indicates the current resolution. Tap to toggle between different resolutions.

- 3 **Storage.** Tap to toggle between saving captured photos or video clips to the device memory () or to the memory card ().
- 4 **Remaining information indicator.** In Photo, Contacts Picture, Picture Theme, Panorama, Sports, and Burst modes, the indicator shows the remaining number of pictures that can be taken based on current settings. In Video mode, the indicator shows the recording time remaining. While recording video, the indicator shows the length of video already recorded.
- 5 **Zoom control.** Tapping the up or down arrow ( / ) or tapping  /  on the screen allows you to zoom in or zoom out.
- 6 **Camera Settings.** Tap the **Tool** icon () to open the Camera Settings screen.
- 7 **Viewer.** Tap the **Viewer** icon () to open the Pictures & Videos screen.
- 8 **Brightness.** Tapping the minus or plus icon ( / ) decreases or increases the brightness level.
- 9 **Metering Mode.** Tap to toggle the metering mode between **Center Area** () and **Average** ().
- 10 **Flash Light.** Tap to turn on or off the flash light that is located at the back of your device. Turn the flash light on when taking shots in dark environments.
- 11 **White Balance.** Tap to toggle between the different white balance settings: Auto (), Daylight (), Night (), Incandescent (), and Fluorescent ().
- 12 **Self-timer.** Tap to set the self-timer to 2 seconds, 10 seconds, or off when in the Photo or Contacts Picture mode. When you press the ENTER button or the Camera Key to capture a still image, the self-timer begins counting, and then captures a still image after the assigned time (2 seconds or 10 seconds).



Video mode

- 13 **Recording indicator.** This indicator blinks red while video recording is in progress.

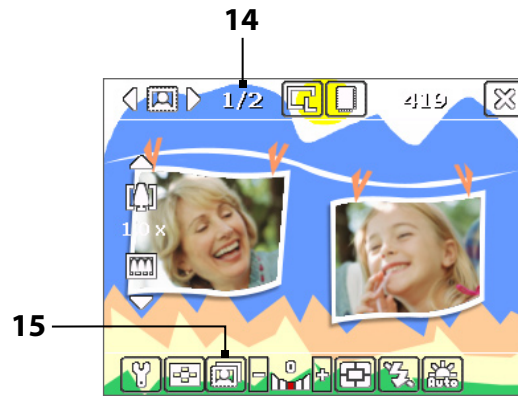

Picture Theme mode

14 Progress indicator. In Picture Theme, Panorama, Sports, and Burst modes, this shows the total number of consecutive shots.

15 Template Selector icon. In Picture Theme mode, tap  to toggle among the different templates.



Panorama mode

16 Stop. The Stop icon () appears only in Panorama mode. Tap this icon if you want to stop capturing the remaining shots and start composing the panorama.

17 Exit. Tap the Exit icon () to exit the Camera program.

Still Image Capture Modes

While using Still Image capture modes, such as Photo, Contacts Picture, Picture Theme, Panorama, Sports, and Burst, you can capture one or more still images by pressing the **Camera Key** or **Jog Wheel**, or the **ENTER** button on the Navigation Control. Still images will be saved in JPEG format.

While capturing an image in the Picture Theme capture mode, you can select a preset template. To view and select from different templates, tap  on the Camera screen. Depending on the chosen template, one or more photos may need to be taken for the template.

Video Capture Mode

In Video capture mode, press the Camera Key, Jog Wheel, or the ENTER button to start recording a video clip. To stop recording, press again.

Before you capture a video clip, you can set the file format and specify the desired length of recording in terms of time or file size on the Camera Settings screen. For information about the available capture formats for video, see “Supported File Formats” in this section.

The Review Screen

After taking a still image or recording a video clip, you can view the image or video clip on the **Review screen**. In addition, you can tap the icons at the bottom of the Review screen to delete a captured image or video, send an image or video via email, and more.

Review screen icons

Photo, Video, Picture Theme, and
Panorama modes



1 2 3 4

Contacts Picture mode

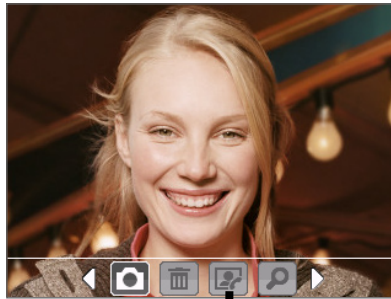







5



Sports and Burst modes



6

- 1 **Back.** Tap  to go back to the Camera screen.
- 2 **Delete.** Tap  to remove the captured image or video.
- 3 **Send.** Tap  to send via email.
- 4 **View.** Tap  to view the image in the Pictures & Videos program, or play the captured video in Windows Media Player.
- 5 **Assign to Contacts.** Tap  to associate the photo to a selected contact.
- 6 **Browse.** After you have taken photos in Sports or Burst mode, the total number of consecutive shots is shown in the lower right corner of the Review screen. Tap the up/down arrow () to browse through the sequence of photos.

To change the display duration of the Review screen:

1. Tap  to open the Camera Settings screen.
2. On the Camera Settings screen, tap . The Advanced menu then appears.
3. Tap **Review Duration**, and then tap the desired time length for displaying captures on the Review screen.

Zooming

While capturing a still image or a video clip using the camera, you can zoom in to make the object in focus move closer, and you can zoom out to make the object move farther away. In all capture modes, use the Navigation Control on your device or tap the triangular Up arrow above the Zoom Ratio indicator to zoom in your subject. When the zooming limit is reached, you will hear a beep. To zoom out, press the Navigation Control down or tap the Down arrow.

Zoom range

The camera zoom range for a picture or a video clip depends on the capture mode and capture size:

Capture mode	Capture size setting	Zoom range
Photo	2M (1600 x 1200)	No zooming available
	1M (1280 x 960)	1.0x to 2.0x
	Large (640 x 480)	1.0x to 2.0x
	Medium (320 x 240)	1.0x to 4.0x
	Small (160 x 120)	1.0x to 8.0x
Video	Medium (176 x 144)	1.0x to 2.0x
	Small (128 x 96)	1.0x to 2.0x
Contacts Picture	Large (480 x 640)	1.0x to 2.0x
	Medium (240 x 320)	1.0x to 4.0x
	Small (120 x 160)	1.0x to 4.0x
Picture Theme	Determined by the current template	Depends on the size of the template currently loaded
Panorama	Large (640 x 480)	1.0x to 2.0x
	Medium (320 x 240)	1.0x to 4.0x
	Small (160 x 120)	1.0x to 8.0x
Sports	Large (640 x 480)	1.0x to 2.0x
	Medium (320 x 240)	1.0x to 4.0x
	Small (160 x 120)	1.0x to 8.0x
Burst	Large (640 x 480)	1.0x to 2.0x
	Medium (320 x 240)	1.0x to 4.0x
	Small (160 x 120)	1.0x to 8.0x

The Camera Settings Screen

While capturing a still image or video clip using any capture modes, tap the **Tool** icon () to access the Camera Settings screen. The Camera Settings screen allows you to configure the capture settings.

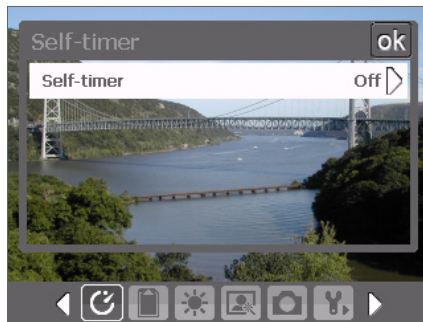

Camera Settings screen in Photo mode

When you tap the icons at the bottom of the Camera Settings screen, different menus will appear. Some menus and options may be available only in certain capture modes.

Tip: You can also press the Navigation Control buttons to navigate menus.

For more information about the different menus and settings, see the succeeding sections.



Self-timer menu

- **Self-timer.** Select the Self-timer option for capturing images: **Off**, **2 seconds**, or **10 seconds**. Selecting 2 seconds or 10 seconds delays capturing by the specified time after you press the Camera Key, the ENTER button, or Jog Wheel.



Template menu

- **Template.** Select a template (in Picture Theme mode only).



Panorama Settings menu

- **Direction.** Choose in what direction images will be stitched in a panorama.
- **Stitch Count.** Select the desired number of snapshots to be taken and stitched into a panorama.
- **Auto Stitch.** When the Auto Stitch is **On**, the camera automatically stitches snapshots into one single file. If Auto Stitch is **Off**, the snapshots are saved as separate files.



Sports Settings menu

- **Snapshots.** Select the number of consecutive shots to capture (in Sports mode).



Flash Light menu

- **Flash Light.** Set this option to **On** to turn on the flash light (located at the back of your device) so that you can shoot photos or video clips in a low-light environment. The flash light is available for use in all capture modes except in Sports and Burst modes.



Ambience menu

- **White Balance.** Select a white balance setting type such as Fluorescent or Night to suit your lighting environment.
- **Effect.** Choose a special effect such as Grayscale or Sepia to apply to your photos or video clips.



Capture Settings menu

- **Resolution.** Select the desired image or video size.
- **Quality.** Select the JPEG image quality level for all captured still images. You can choose from **Basic**, **Normal**, **Fine**, and **Super Fine**.

- **Metering Mode.** Select a metering mode to allow the camera to measure the amount of light in the center and around the image and calculate the best-fit exposure value before capturing. Choose either **Center Area** to measure light using the center area of the image or **Average** to measure light using the area all around the image.
- **Storage.** Select where you want to save your files. You can either save the files to the main memory or to a storage card.

Capture Mode menu

- **Mode.** Switch between different capture modes such as Photo, Video, Contacts Picture, and more. For more information about these modes, see “Capture Modes” earlier in this section.

Advanced menu



Tap the left or right arrow icon in this bar to switch between the menu pages in the Advanced menu.

- **Capture Format.** Select the desired file format.
- **Shutter Sound.** Choose whether you want the camera to make a shutter sound when you press the Camera Key, the ENTER button, or Jog Wheel to take photos or record video clips.
- **Grid (Photo mode only).** Choose whether to display a grid on the Camera screen. Showing a grid helps you frame and center your subject more easily and accurately.



- **Keep Backlight.** Choose whether to turn the backlight on or off while using the camera. This overrides your device backlight settings while you are using the camera.
- **Review Duration.** Set a time length for displaying the captured still or video image on the Review screen before automatically saving it and returning to the live Camera screen. Select **No Limit** if you do not want to impose a time limit. Select **No Review** to immediately return to the live Camera screen after capturing.
- **Flicker Adjustment.** When taking indoor shots, flicker on the camera screen may be caused by inconsistencies between the vertical scan rate of the camera display and the flicker frequency of fluorescent lighting. To reduce flicker, you can change the flicker adjustment setting to the proper frequency (**50Hz** or **60Hz**) of the country where your device is being used.
- **Record with Audio.** Select **On** to record audio with the captured video clips. This is selected by default. If you select **Off** and then capture a video clip, it will have no audio.

- **Prefix.** Specify how to name captured images and video clips. When **Default** is selected, the file name of each new captured file is set to “IMAGE” or “VIDEO” followed by a sequential number (for example, IMAGE_001.jpg). You may also choose to name files using either the current **Date** or **Date & Time** as the prefix.
- **Counter.** By default, the newly captured image or video files are named with a prefix and sequential numbers, such as 001, 002, and so on. To reset the numbering to “001” for your captured files, tap **Reset**.
- **Recording Limit.** Specify the maximum time or file size for recording.
- **Template Folder** (in Picture Theme mode only). By default, templates are stored in the \My Documents\Templates folder in the device’s **Main Memory**. If you transferred some templates to a storage card (via File Explorer), set this option to **Main + Card** to specify that templates are located in both the main memory and on the storage card.
- **Adjust.** This option allows you to adjust camera display properties such as **Contrast**, **Saturation**, **Hue**, and **Sharpness**.

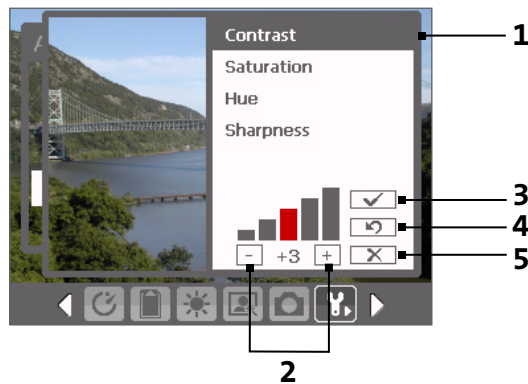

- 1 In the submenu, tap one of the properties to adjust, or press the Navigation Control up or down to select a property.
- 2 To increase or decrease the value, tap the plus or minus icon or press the Navigation Control left or right. The live Camera screen on the background immediately displays the effect of changes.
- 3 Tap to save the settings and close the submenu.
- 4 Tap to reset all properties to their defaults.
- 5 Tap to close the submenu without applying and saving the changes.

12.2 Using Pictures & Videos

The **Pictures & Videos** program collects, organizes, and sorts images and video clips in the following formats on your device.

File Type	File Extensions
Image	*.bmp, *.jpg, *.gif
GIF animation	*.gif
Video	*.avi, *.wmv, *.mp4, *.3gp, *.3g2

You can view the pictures as a slide show, beam them, send them via email, edit them, or set them as the background on the Today screen.

To copy images, GIF animation files, and video clips to your device:

You can copy images, GIF animation files, and video files from your PC and view them on your device.

- ▶ Copy the images, GIF animation files, and video files from your PC or a storage card to the My Pictures folder on your device. (You can also copy video files to the My Videos folder.)

For more information about copying files from your PC to your device, see ActiveSync Help on your PC.

Note:

You can also copy images, GIF animation files, and video files from your PC to your device using a memory card. Insert the memory card into the memory card slot on your device, and then copy the files from your PC to the folder you created on the memory card.

To view pictures:

1. Tap **Start > Programs > Pictures & Videos**. The images in the My Pictures folder appear as thumbnails by default.
2. Select an image and tap **View**.

If you cannot find the desired image in the default My Pictures folder, go to another folder by tapping the Down arrow (▼).

To play GIF animation files:

1. Tap **Start > Programs > Pictures & Videos**.
2. Select a GIF animation file and tap **View**. The GIF Animation program then opens and plays the animation.

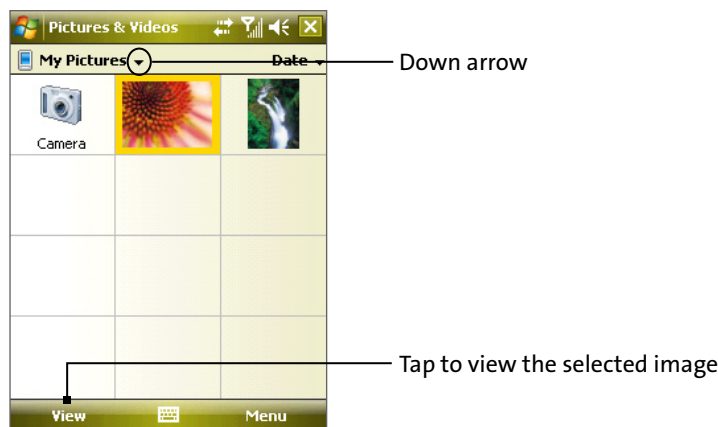

To play videos with audio:

1. Tap **Start > Programs > Pictures & Videos**. By default, the contents of the My Pictures folder will be shown.
2. To find the video clips that you captured, tap the down arrow (▼) next to the My Pictures folder and tap **My Documents**. Next, tap **My Videos**. Video clips are displayed as thumbnails by default, which appear with a media icon (🎵).

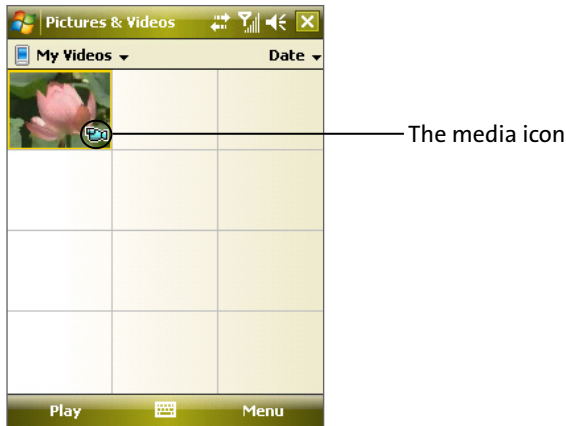

3. Tap to select a video and play it in Windows Media Player.

To view slide shows:

You can view your pictures as a slide show on your device. Pictures are shown in full-screen view with a five-second interval between slides.

1. Tap **Start > Programs > Pictures & Videos**.
2. Tap **Menu > Play Slide Show**.

Note:

You can specify how pictures are scaled to optimize their display in a slide show. Tap **Menu > Options**, and then tap **Portrait pictures** or **Landscape pictures** on the **Slide Show** tab.

Tap anywhere on the screen to display the Slide Show toolbar, which you can use to stop or pause the slide show, rotate the view, and more.

To sort pictures and video clips:

If you store a large number of pictures or video clips on your device, you may find it helpful to sort them to quickly find a specific picture or clip. You can sort by name, date, and size.

1. Tap **Start > Programs > Pictures & Videos**.
2. Tap the sort list (labeled **Date** by default), and select the item you want to sort by (**Name**, **Date**, or **Size**).

To delete a picture or video clip:

Do either of the following to remove a picture or a video clip:

- ▶ Select a picture or video clip on the Pictures & Videos screen, and tap **Menu > Delete**.
- ▶ Tap and hold the thumbnail of the picture you want to delete, and then tap **Delete**.

Tap **Yes** to confirm the deletion.

To edit a picture:

You can rotate, crop, and adjust the brightness and color contrast of your pictures.

1. Tap **Start > Programs > Pictures & Videos**.
2. Tap the picture you want to edit.
3. Tap **Menu > Edit**, and do any of the following:
 - To rotate a picture 90 degrees clockwise, tap **Rotate**.
 - To crop a picture, tap **Menu > Crop**. Next, tap and drag to select the area to crop. Tap inside the box to crop, or tap outside the box to cancel cropping.
 - To adjust the brightness and contrast levels of a picture, tap **Menu > Auto Correct**.

Note:

To undo an edit, tap **Menu > Undo**. To cancel all unsaved edits you made to the picture, tap **Revert to Saved**.

To set a picture as the Today screen background:

You can use a picture as the background on the Today screen.

1. Tap **Start > Programs > Pictures & Videos**.
2. Select the picture you want to set as the background.
3. Tap **Menu > Set as Today Background**.
4. In **Transparency level**, select a higher percentage for a more transparent picture, or a lower percentage for a more opaque picture.
5. Tap **OK**.

To send pictures and video clips via email:

You can send pictures and video clips to other devices via email.

1. Ensure that Messaging is set up to send and receive messages.
2. From the program, select the item you want to send.
3. Tap **Menu > Send**, and select one account (such as Outlook email) to send the attached item. (A new message is created with the item attached.)
4. Enter the recipient name and subject, and tap **Send**. The message will be sent the next time you synchronize your device.

Note:

Pictures and video clips are saved automatically before they are sent.

To beam a picture or video clip:

You can beam a picture or video file to another mobile device using infrared.

1. Tap **Start > Programs > Pictures & Videos**.
2. Select the picture or video file you want to beam.
3. Tap **Menu > Beam**.
4. Select a device to beam the file to.
5. Tap **OK**.

To assign pictures to contacts:

You can assign a picture to a contact so that you can easily identify the contact.

1. Tap **Start > Programs > Pictures & Videos**.
2. Select the picture you want to assign to a contact.
3. Tap **Menu > Save to Contact**.
4. Tap the contact, or navigate and tap **Select** to choose the contact from your Contacts list.

To customize more image settings:

1. Tap **Start > Programs > Pictures & Videos**.
2. Select the picture for which you want to configure further settings.
3. Tap **Menu > Options**. The Options screen appears, allowing you to:
 - Resize a picture so that it can be sent more quickly through email.
 - Set the direction of rotation for the Rotate function.
 - Configure the view settings during slide shows and activate screensaver options.

12.3 Using Windows Media Player

You can use Microsoft Windows Media Player 10 Mobile for Pocket PC to play digital audio and video files that are stored on your device or on a network, such as on a Web site.

Using Windows Media Player, you can play both audio and video files. The following file formats are supported by this version of Windows Media Player.

Video File Formats Supported	File Extensions
Windows Media Video	.wmv, .asf
MPEG4 Simple Profile	.mp4
H.263	.3gp
Motion JPEG	.avi
3GPP2	.3g2

Audio File Formats Supported	File Extensions
Windows Media Audio	.wma
MP3	.mp3
MIDI	.mid, .midi, .rmi
AMR Narrow Band	.amr
AMR Wide Band	.awb
AAC	.m4a
3GPP2	.gcp

About the Controls

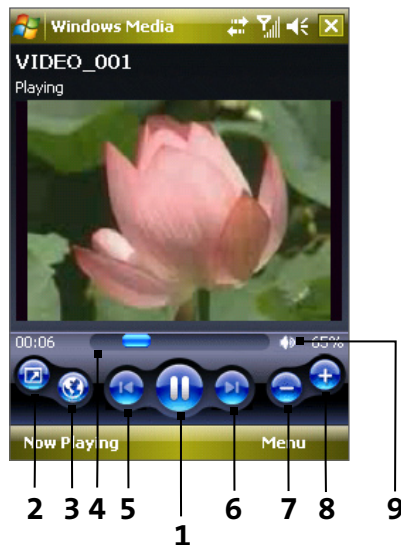

The following are available controls on the Windows Media Player.

Control	Function
1	Plays/Pauses a file.
2	Displays the video full-screen.
3	Displays a Web site where you can find music and videos to play.
4	Adjusts the playback progress of a selected file.
5	Skips to the beginning of the current file or to the previous file.
6	Skips to the next file.
7	Decreases the volume level.
8	Increases the volume level.
9	Turns the sound on or off.

About the Screens and Menus

Windows Media Player has three primary screens:

- **Playback screen.** The default screen that displays the playback controls (such as Play, Pause, Next, Previous, and Volume) and the video window.
- **Now Playing screen.** The screen that displays the Now Playing playlist. This special playlist indicates the current file being played and any files that are “queued up” to play next.
- **Library screen.** The screen that lets you quickly find your audio files, video files, and playlists. It contains categories such as My Music, My Videos, My TV, and My Playlists.

At the bottom of each screen, you can open a **Menu**. The commands on this menu vary, depending upon which screen you are viewing. For more information about the commands in these menus, see Help on your device.

About Licenses and Protected Files

Some content (such as digital media files downloaded from the Internet, CD tracks, and videos) have associated licenses that protect them from being unlawfully distributed or shared. Licenses are created and managed by using digital rights management (DRM), which is the technology for securing content and managing its access rights. Some licenses may prevent you from playing files that have been copied to your device. Files that have licenses associated with them are called “protected files.”

If you want to copy a protected file from your PC to your device, use the desktop player to synchronize the file to your device (instead of dragging the file from a folder on your PC to a folder on your device, for example). This will ensure that the license is copied along with the protected file. For more information about synchronizing files to your device and other mobile devices, see desktop player Help.

Note: You can view the protection status for a file by checking its file properties (tapping **Menu > Properties**).

Synchronizing Video and Audio Files

Use the latest version of Microsoft Windows Media Player on your PC to synchronize digital media files from your PC to your device. This ensures that protected files and album art are copied to your device correctly.

To synchronize content to your device automatically:

1. On your PC, start Windows Media Player and then connect your device to your PC.
2. In the Device Setup Wizard, select **Yes, search my computer now**.
3. You will then see the name of your device (or “Storage Card” if you have inserted one on your device). Click **Finish**.
4. On the left panel of Windows Media Player, right-click the name of your device and then click **Set Up Sync**.

Note: To set up media synchronization on a storage card, right-click **Storage Card** in the left panel of Windows Media Player, and then click **Set Up Sync**.

5. On the Device Setup dialog box, select **Sync this device automatically**.
6. Select the playlist(s) that you want to sync between your PC and device, and then click **Add**.
7. Click **Finish**.

The files begin synchronizing to your device. The next time you connect your device to your PC while Windows Media Player is running, synchronization will start automatically.

To synchronize content manually to your device

1. If you have not set up media synchronization between your device and PC, follow steps 1 to 3 in “To synchronize content to your device automatically.”
2. Click the **Sync** tab on the Windows Media Player of your PC. Select a Playlist or a Library on the left panel of the Windows Media Player.
3. From the Content List, drag the media files that you want to sync to your device and drop them to the Sync List.

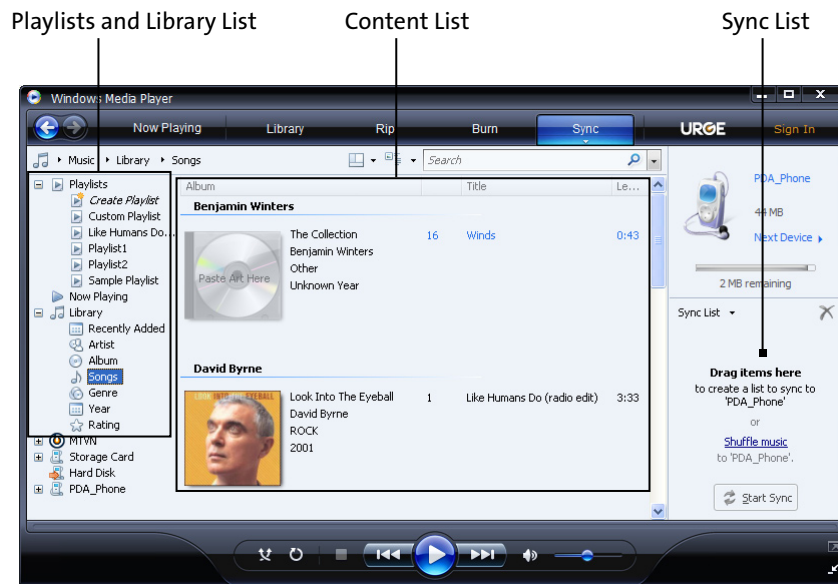

4. Click **Start Sync** to start synchronizing the selected files to your device.

Notes:

Use Windows Media Player 11 or higher on your PC to synchronize media files to your device. Audio files copy faster if Windows Media Player is configured to automatically set the quality level for audio files copied to your device. For more information, see the Windows Media Player Help.

Playing Media

To play items on your device:

Use the library on Windows Media Player Mobile to find and play songs, videos, and playlists that are stored on your device or removable storage card.

1. If you are not on the Library screen, tap **Menu > Library**.
2. On the Library screen, tap the Library arrow (near the top of the screen), and then tap the media storage that you want use, for example, Storage Card.
3. In most cases, Windows Media Player Mobile automatically updates the library. However, you can manually update the library to ensure that it contains new files that you recently copied to your device or storage card. Tap **Menu > Update Library** to manually update the library list.
4. Select a category (for example, My Music or My Playlists).
5. Tap and hold the item that you want to play (such as a song, album, or artist name), and then tap **Play**.

Note:

To play a file that is stored on your device but is not in a library, on the Library screen, tap **Menu > Open File**. Tap and hold the item that you want to play (such as a file or a folder), and then tap **Play**.

To play an item on a network:

Use the **Open URL** command to play a song or video that is stored on the Internet or on a network server.

1. If you are not on the Library screen, tap **Menu > Library**.
2. Tap **Menu > Open URL**.
3. Do one of the following:
 - In the **URL** box, enter a network address.
 - In the **History** box, tap a URL that you have previously used.

Note:

To play an item on a network, you must be connected to a network. For more information about creating a remote connection between your device and a network, see Connections Help on your device.

Using Playlists

A playlist is a list of digital media files that play in a specified order. By using playlists, you can group audio and video files together for convenient playback.

In the desktop Player, you can create a playlist of media files and synchronize the desktop Player with your device.

In Windows Media Player on your device, your playlists are available in the Library under the My Playlists category. There is also a temporary playlist, called Now Playing, which lists the currently playing file, as well as any files that have been queued up to play next. You can create a new playlist on your device by saving the current Now Playing playlist and by giving it a new name.

To save a new playlist:

1. If you are not on the Library screen, tap **Menu > Library**.
2. Tap to select a category (for example, My Music or My Playlists).
3. Select a media file that you want, and then tap **Menu > Queue Up**. This adds the file to the Now Playing list.

Repeat this step until you have added all desired media files to the Now Playing list.

Note:

You cannot select multiple files simultaneously.

4. After adding the media files, tap **Menu > Now Playing**.
5. On the Now Playing screen, tap **Menu > Save Playlist**.
6. Enter the playlist name and then tap **Done**.
7. To play back the playlist you created, tap My Playlists in the Library, select your playlist, and then tap **Play**.

Troubleshooting

If you encounter a problem while using the Windows Media Player, a number of resources are available to help you troubleshoot the issue.

For more information, see the Troubleshooting Windows Media Player Mobile page at the Microsoft Web site (<http://www.microsoft.com/windows/windowsmedia/player/windowsmobile/troubleshooting.aspx>).

Section 13

Managing Your Device

In This Section

13.1 Adding and Removing Programs

13.2 Using Task Manager

13.3 Managing Memory

13.4 Resetting Your Device

13.5 Checking System Information

13.6 Battery Saving Tips



13.1 Adding and Removing Programs

Before purchasing additional programs for your device, you should note the name of your device, the version of Windows Mobile software running on it, and the type of processor. This information will help you select a program that is compatible with your device. For more information, see “To find the operating system version number and detailed device information” in this section.

Programs available for purchase usually include a setup program (commonly named “setup.exe”) that you must first install on your PC. You can then use ActiveSync to add programs to your device, or add a program directly from the Internet.

To add programs:

1. Download the program to your PC (or insert the CD or disk that contains the program into your PC). You may see a single *.exe file, a *.zip file, a **Setup.exe** file, or several versions of files for different device types and processors. Be sure to select a program designed for your device and processor type.
2. Read any installation instructions or documentation that comes with the program. Many programs provide special installation instructions.
3. Connect your device and PC.
4. Double-click the *.exe file.
 - If the executable file is an installation wizard, follow the instructions on the screen. The wizard will automatically install the program to your device.
 - If an installation wizard does not start, you will see an error message stating that the program is valid but that it is designed for a different type of computer. You will need to copy this program directly to your device. If you cannot find any installation instructions for the program, use ActiveSync to copy the program file to the Program Files folder on your device.

To remove programs:

You can remove only programs that you installed. Programs that have been pre-loaded onto your device cannot be removed.



1. Tap **Start > Settings > System tab > Remove Programs**.
2. In the **Programs in storage memory** list, select the program you want to remove, and then tap **Remove**.
3. Tap **Yes**. If another confirmation message appears, tap **Yes** again.

Note:	Your device does not allow you to uninstall most of the preinstalled programs.
--------------	--

13.2 Using Task Manager

Task Manager lets you view and stop running programs, configure the **Exit** button (), and enable the **Quick Menu** on the Today screen.

To open Task Manager:

- ▶ Tap the **Quick Menu** button () on the top right corner of the Today screen to open the **Quick Menu**, and then tap the **Options** icon ().
—or—
- ▶ Tap **Start > Settings > System tab > Task Manager**.

To switch back to a running program:

- ▶ Tap the program name in the **Quick Menu**.
—or—
- ▶ On the Task Manager screen, tap the program name in the **Running** tab, and then tap **Activate**.



To configure the Exit button ():

You can configure the **Exit** button () to shut down running programs when the button is tapped, or to just temporarily close the program screen but keep the program running.

1. On the Task Manager screen, tap the **Button** tab.
2. Select the **Enable the “X” button to end running programs** check box.

Note:

When the **Enable the “X” button to end running programs** check box is not selected, tapping the **Exit** button will only close a program screen. The program is not ended and continues to run in the background.

3. Choose an action for shutting down programs (by tapping the  button, tapping and holding the  button, or both).
4. Tap **OK**.

To close running programs from the Task Manager:

1. Tap the **Running** tab.
2. Select the check box of the programs that you want to close, and then tap **Stop Selected** to close them.

—or—

Tap **Stop All** to close all programs in the list.

—or—

Tap **Menu > Stop All but Selected** to close all programs except for those whose check boxes are selected.

Tip:

You can also close running programs from the **Quick Menu** on the Today screen. See “**Quick Menu**” in Section 1 for details.

To add a running program to the exclusive list:

If you add a running program to the **Exclusive Programs List**, it will not be closed when you tap **Stop Selected** or **Stop All** and will not be listed in the **Quick Menu** on the Today Screen.

1. On the Task Manager screen, tap the **Running** tab.
2. Tap and hold the program name in the list, and then tap **Add Exclusive**.

To remove a program from the exclusive list:

- ▶ In the **Running** tab, tap and hold the program name in the list, and then tap **Remove from Exclusive**.
—or—
- ▶ In the **Exclusive** tab, select the program name and tap **Remove**.

To sort running programs in the Quick Menu:

1. Tap the **Advanced** tab.
2. Select **Program name** or **Memory usage** to sort running programs by order of the program name or memory usage.

13.3 Managing Memory

You may need to stop a program if it becomes unstable or the program memory is low.

To see how much memory is available:

- ▶ Tap **Start > Settings > System tab > Memory**. On the **Main** tab, the amount of memory allocated to file and data storage versus program storage is displayed, as well as the amount of memory in use versus the available memory.

To see available storage card memory:

You can see how much memory is available on a storage card that is inserted in the device.

1. Tap **Start > Settings > System tab > Memory**.
2. Tap the **Storage Card** tab.

To free up program memory:

Try the following to free memory on the device:

- Close programs you are not currently using.
- Move email attachments to a storage card.
- Move files to a storage card. Tap **Start > Programs > File Explorer**. Tap and hold the file, and then tap **Cut**. Browse to the storage card folder and tap **Edit > Paste**.
- Delete unnecessary files. Tap **Start > Programs > File Explorer**. Tap and hold the file, and then tap **Delete**.
- Delete large files. To find your largest files, tap **Start > Programs > Search**. In the **Type** list, tap **Larger than 64 KB**, and then tap **Search**.
- In Internet Explorer Mobile, delete temporary Internet files and clear history information. For more information, see “Internet Explorer Mobile” in Section 11.
- Remove programs you no longer use.
- Reset your device. (See “Resetting Your Device” later in this section.)

To close a program:

In most cases, tapping the **Close** icon button in the title bar just closes a program screen. The program continues to run in the background. You can end running programs manually by following these steps:

1. Tap **Start > Settings > System tab > Memory > Running Programs** tab.
2. In the **Running Programs List**, tap the program you want to close, and then tap **Stop**.

Tip:

In most programs, you can also tap the keyboard shortcut **CTRL+Q** on the onscreen keyboard to close the program.

13.4 Resetting Your Device

Soft Reset

Occasionally you may need to reset your device. A soft (or normal) reset of your device clears all active program memory and shuts down all active programs. This can be useful when the device is running slower than normal, or a program is not performing properly. A soft reset is also necessary after the installation of some programs. If a soft reset is performed when programs are running, unsaved work will be lost.

To perform a soft reset:

- ▶ Use the stylus to lightly press and hold the **RESET** button on the bottom of your device. The device restarts, and then displays the Today screen.

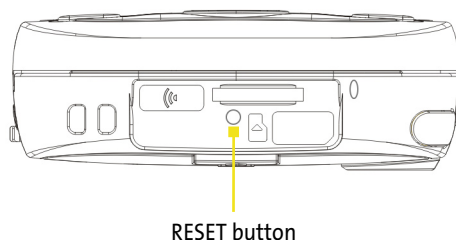

Tip: To avoid data loss, please turn off your device before performing a soft reset.

Hard Reset

You can also perform a hard reset (also known as a full reset). A hard reset should be performed only if a normal reset does not solve a system problem. After a hard reset, the device is restored to its default settings — the way it was when you first purchased it and turned it on. Any programs you installed, data you entered, and settings you customized on the device will be lost. Only Windows Mobile software and other pre-installed programs will remain.

To perform a hard reset:

1. Press and hold both softkeys on the device. Keep these keys pressed, and at the same time, use the stylus to lightly press and hold the **RESET** button on the bottom of your device.

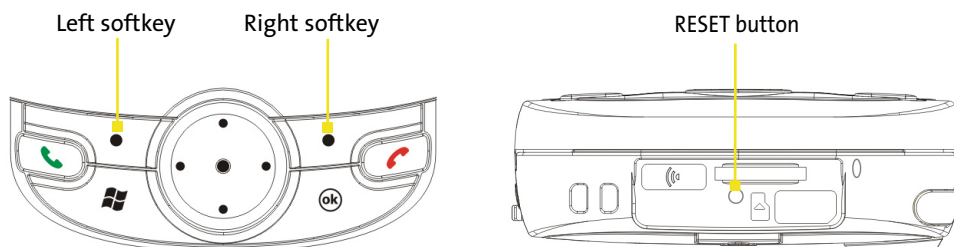

2. Release the stylus but keep the softkeys pressed when you see the following message on your device screen:

“Do you want to erase all user data and restore to manufacture default?”

3. Slide open the hardware keyboard, and press **R** to restore to factory default or press **X** to exit the hard reset process.

Note: Your device will be set back to factory default settings. Please ensure any additional installed programs and user data have been backed up before a hard reset is performed.

13.5 Checking System Information

If you want to find out about technical details of your device such as the type or speed of the processor, memory size, etc., you can check under Settings for device information.

To find the operating system version number:

- ▶ Tap **Start > Settings > System tab > About**.

The version of the operating system on your device is shown near the top of the About screen.

To get detailed device information:

- ▶ Tap **Start > Settings > System tab > About**.

13.6 Battery Saving Tips

How long your battery power lasts depends on battery type and how you use your device. Here are a few tips on saving battery power:

- ▶ When the device is not in use, press the Power Key to switch off the display.
- ▶ Tap the battery icon () on the Today screen. On the **Advanced** tab of the Power settings screen, you can specify when your device automatically turns off the display to conserve battery power. For optimum conservation, specify three minutes or less.
- ▶ Use the AC phone charger to plug your device into external power whenever possible, especially when using a storage card or when using a modem or other peripherals.
- ▶ Adjust the backlight settings. For more information, see “To set the backlight to dim after a time delay” in Section 4.
- ▶ When you are out of range of wireless networks, turn Wi-Fi off. Searching for networks consumes a lot of power. For more information, see “Wi-Fi” in Section 11.
- ▶ Turn Bluetooth off when you are not using it. For more information, see “Using Bluetooth” in Section 11.
- ▶ Lower the volume.
- ▶ Close battery-intensive programs, such as the Camera, when you are done using them. Make sure the programs are ended and are not continuously running in the background. For more information about ending running programs, see “To close a program” in this Section.

Section 14

Using Other Applications

In This Section

.....

14.1 Using Java

14.2 Using Voice Speed Dial

.....



14.1 Using Java

MIDlets are Java applications such as games and tools that can run on mobile devices, while a MIDlet suite is a collection of one or more MIDlets. The **Java** program lets you download, install and manage MIDlets or MIDlet suites on your device. Your device supports Java 2 Micro Edition, J2ME.

To open the Java program:

- ▶ Tap **Start > Programs > Java**.

Installing and Launching MIDlets or MIDlet Suites

There are two ways to install a MIDlet or MIDlet suite.

To download and install via Internet Explorer Mobile:

1. On the Java screen, tap **Menu > Install > Browser** to open Internet Explorer Mobile.
2. Locate the MIDlet/MIDlet suite while connected to the Internet.
3. Select the MIDlet/MIDlet suite to download.
4. Information about the MIDlet/MIDlet suite is then displayed. Tap **Continue**.
5. Confirm to start downloading.
6. When finished, tap **OK**.

To install from your device:

You can copy MIDlets or MIDlet suites from the PC to your device using the USB sync cable, infrared, or Bluetooth connection. Copy them to the root folder or any subfolder on your device.

1. On the Java screen, tap **Menu > Install > Local Files**. The program then searches for MIDlets or MIDlet suites on your device and displays them in a list.
2. From the list, tap the MIDlet/MIDlet suite that you want to install.
3. Confirm to start the installation.
4. When finished, tap **OK**.

To run a MIDlet or MIDlet suite:

Do one of the following:

- ▶ After installation of the MIDlet/MIDlet suite is complete, select **Run** and tap **OK**.
— or —
- ▶ On the Java screen, open the folder that contains the MIDlet/MIDlet suite. Select the MIDlet/MIDlet suite and then tap **Launch**.

To stop running a MIDlet or MIDlet suite:

- ▶ Tap **Exit** or **Quit** on the MIDlet's or MIDlet suite's screen or menu.

Managing MIDlets and MIDlet Suites

You can organize MIDlets or MIDlet suites into folders for easy identification, move them from one folder to another, rename or update them, and more. If the device memory is full, uninstall some MIDlets or MIDlet suites to free up memory space.

To create folders:

1. Tap **Menu > New Folder**.
2. Enter a folder name and then tap **Create**.

To move a MIDlet to another folder:

1. Tap and hold a MIDlet or MIDlet suite and then tap **Move**. Alternatively, you can tap **Menu > Edit > Move**.
2. Tap the destination folder.

To rename a MIDlet or folder:

1. Tap and hold a MIDlet/MIDlet suite and then tap **Rename**. Alternatively, you can tap **Menu > Edit > Rename**.
2. Enter a new name, and then tap **Save**.

To update a MIDlet or MIDlet suite:

- ▶ Tap and hold a MIDlet or MIDlet suite and then tap **Update**. Alternatively, you can tap **Menu > Edit > Update**. Java will search for updates for the selected MIDlet or MIDlet suite.

To remove MIDlets:

Before you uninstall a MIDlet, make sure that it is not running.

1. Tap and hold the MIDlet, and tap **Erase**. Alternatively, you can tap **Menu > Edit > Erase**.
2. Tap **OK** to confirm.

Note: To uninstall all MIDlets and folders from the current folder, tap **Menu > Remove All**.

To set MIDlet permission settings:

For each MIDlet already installed, Java allows you to individually set permission options to perform certain actions. A MIDlet can be enabled to perform these actions:

Action	Description
Local connection	Enables a MIDlet to access device connections, such as via Bluetooth.
Location information access	Determines whether a MIDlet can access location related information.
Recording	Enables a MIDlet to record audio and images.
Messaging	Enables a MIDlet to send or receive SMS. You will be charged for airtime minutes.
Net access	Enables a MIDlet to access the Internet. You will be charged for airtime minutes.
Auto start	Enables a MIDlet to be started automatically to handle an incoming event. If there is another MIDlet running, it may be interrupted.
Read user data	Allows a MIDlet to read data on the device memory or storage card.

Note: Some actions may not be available for certain MIDlets.

You can set permission options for performing each action by following these steps:

1. Tap and hold a MIDlet and then tap **Security**, or tap **Menu > Edit > Settings**.
2. For each action, choose one of the following permission options:
 - **Always Allow**. Enables a MIDlet to perform the action.
 - **Never Allow**. Prohibits a MIDlet from performing the action.
 - **Ask**. Asks for your confirmation whenever a MIDlet attempts to perform the action.
3. Tap **Save**.

Note:

Changes to permission settings for a MIDlet in a multi-MIDlet suite will affect the settings for the whole suite.





14.2 Using Voice Speed Dial

You can record voice tags so that you can dial a phone number or launch programs simply by speaking into your device.

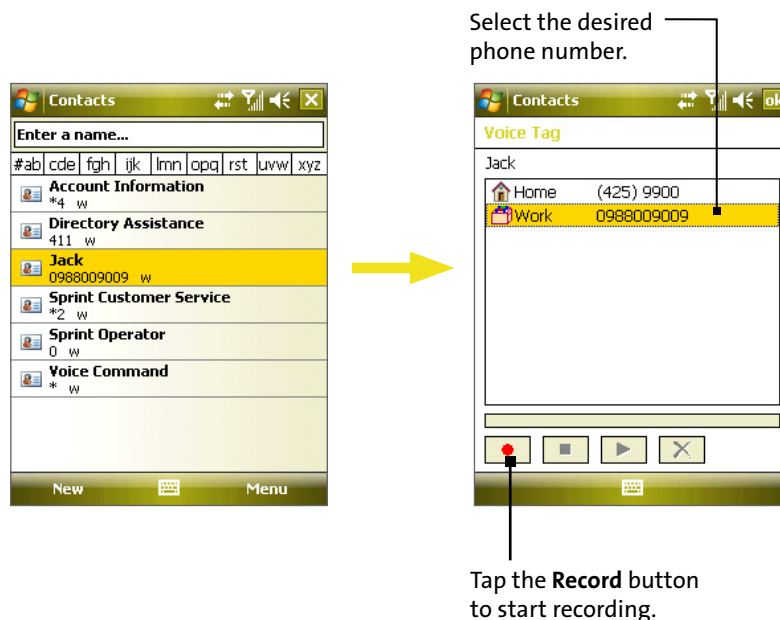
To create a voice tag for a phone number:

1. Tap **Contacts** on the Today screen to open the Contacts list.
2. Do one of the following:
 - Tap and hold the desired contact, and then tap **Add Voice Tag**.
 - Select the desired contact, and then tap **Menu > Add Voice Tag**.
 - Tap the desired contact to open the contact's detailed screen, and then tap **Menu > Add Voice Tag**.
3. Select the phone number for which you want to create a voice tag, and then tap the **Record** button ().



4. When recording is completed, a **Voice Tag** icon () will be displayed on the right of the item.
5. When you create a voice tag for the item, you can do any of the following:
 - Tap the **Record** button () to rebuild the voice tag.
 - Tap the **Play** button () to play the voice tag.
 - Tap the **Delete** button () to delete the voice tag.

Tip: To ensure voice recognition accuracy, please record your voice in a quiet place.

To create voice tag for a program:

1. Tap **Start > Settings > Personal tab > Voice Speed Dial**.

Note: The **Application** tab displays a list of all installed programs on your device. The procedure for creating a voice tag for a program is the same as the procedure for creating a voice tag for a phone number.

2. After you have created a voice tag for a program, you can then launch the program by saying the recorded voice tag after pressing the Voice Command Key.



To make a call or launch programs using voice tags:

1. Press the Voice Command Key.
2. After a “beep” sound, say the recorded voice tag that you have assigned to the phone number you want to call or the program you want to launch. The system will repeat the voice tag and then dial out or launch the program automatically.

Note:

If the system cannot recognize your voice tag, please speak clearly and reduce the surrounding noise, and then try again.

To view and test the voice tags you have created

1. Tap **Start > Settings > Personal tab > Voice Speed Dial**.
2. The **Voice Tag** tab displays a list that contains all the voice tags you have created. Select an item in the list, and you can do one of the following:
 - Tap the **Record** button () to rebuild the voice tag.
 - Tap the **Play** button () to play the voice tag.
 - Tap the **Delete** button () to delete the voice tag.

Appendix

In This Section

.....
A.1 Specifications

A.2 Regulatory Notices

A.3 Additional Safety Information
.....



A.1 Specifications

System Information	
Processor	QUALCOMM® MSM7500, 400 MHz
Memory	ROM : 256 MB embedded NAND Flash RAM : 64 MB SDRAM (Figures are the total ROM and RAM memory available for use and storage. Since the memory is shared by the Operating System, applications, and data, the actual available memory is less than what is written.)
Operating System	Windows Mobile® 6.1 Professional
Power	
Battery	Rechargeable Lithium-Ion polymer battery, 1500 mAh
Charging Time	Under 4 hours
AC Phone Charger	Voltage range/frequency: 100 - 240V AC, 50/60 Hz DC output: 5V and 1A
Display	
LCD Type	2.8" transmissive TFT-LCD with backlight LEDs, touch-sensitive screen
Resolution	240 x 320 dot pixels with 64K colors
Alignment	Portrait and Landscape
Cellular Radio Module	
Functionality	CDMA2000 1xEVDO/1xRTT and IS-95A/B voice or data
Mode	Dual-band (800 and 1900 MHz)
Internal Antenna	Yes
Physical	
Dimensions	4.3" (L) x 2.3" (W) x 0.7" (T)
Weight	6.5oz (with battery)
Camera Module	
Type	2 Megapixel color CMOS camera with flash
Resolution	Photo: 1600x1200 (UXGA), 1280x960 (SXGA), 640x480 (VGA), 320x240 (QVGA), 160x120 (QQVGA) Video: 352x288 (CIF), 320x240 (QVGA), 176x144 (QCIF), 128x96
Digital Zoom	Up to 8x

Connections	
Infrared	IrDA SIR
I/O Port	HTC ExtUSB™ : an 11-pin mini-USB and audio jack in one (ExtUSB is a proprietary connection interface that is trademarked by HTC).
Car Antenna Connector	For connecting to an external phone antenna (850MHz and 1900MHz)
Wireless Connections	Bluetooth®, Wi-Fi®
Controls and Lights	
Navigation Buttons	<ul style="list-style-type: none"> • 5-way Navigation Control • Five program buttons : Camera Key, Comm Manager Key, Messaging Key, Web Key, Voice Command Key • Two phone functions : Talk Key and End Key • Start Key • Two OK Keys • Two softkeys • Jog Wheel • Power Key • RESET button • WLAN switch
Hardware Keyboard	QWERTY keyboard with two additional softkeys, and an ambient sensor that detects low light and automatically illuminates the keyboard.
LEDs	<p>The left LED shows the following:</p> <ul style="list-style-type: none"> • A blinking Blue light for Bluetooth system notification of powered-up and ready to transmit radio frequency signal. • A blinking Green light for Wi-Fi status. • When both Bluetooth and Wi-Fi are enabled, their lights blink alternately. <p>The right LED shows Green and Amber lights for CDMA standby and network status, notification, and battery charging status.</p>
Audio	
Audio Controller	AGC
Microphone/Speaker	Built-in/Dual, Hands-free
Audio Formats	MP3/WAV/WMA/AAC/AAC+ codec
Expansion Slots	
Memory Card Slot	microSD™

A.2 Regulatory Notices

Regulatory Agency Identifications

For regulatory identification purposes, your **Mogul** is assigned a model number of TITA100.

FCC ID: NM8TITA100. IC: 4115A-TITA100.

To ensure continued reliable and safe operation of your device, use only the accessories listed below with your **Mogul**.

The Battery Pack has been assigned a model number of TRIN160.

This product is intended for use with a certified Class 2 Limited Power Source, rated 5 Volts DC, maximum 1 Amp power supply unit.

Federal Communications Commission Notice

DECLARATION OF CONFORMITY

UT Starcom hereby declares that this wireless device, **Mogul**, manufactured by High Tech Computer Corp., is in compliance with the essential requirements and other relevant provisions of Directive 1999/5/EC.

This wireless device, **Mogul**, manufactured by High Tech Computer Corp., complies with part 15 of the FCC Rules. Operation is subject to the following two conditions: (1) This device may not cause harmful interference, and (2) this device must accept any interference received, including interference that may cause undesired operation. Responsible Party: High Tech Computer Corp.

This equipment has been tested and found to comply with the limits for a Class B digital device, pursuant to Part 15 of the FCC Rules. These limits are designed to provide reasonable protection against harmful interference in a residential installation. This equipment generates, uses, and can radiate radio frequency energy and, if not installed and used in accordance with the instructions, may cause harmful interference to radio communications. However, there is no guarantee that interference will not occur in a particular installation. If this equipment does cause harmful interference to radio or TV reception, which can be determined by turning the equipment on and off, the user is encouraged to try to correct the interference by one or more of the following measures:

- Reorient or relocate the receiving antenna.
- Increase the separation between the equipment and receiver.
- Connect the equipment into an outlet on a circuit different from that to which the receiver is connected.
- Consult the dealer or an experienced radio or television technician for help.

FCC RF EXPOSURE INFORMATION

In August 1996, the Federal Communications Commission (FCC) of the United States with its action in Report and Order FCC 96-326 adopted an updated safety standard for human exposure to radio frequency electromagnetic energy emitted by FCC regulated transmitters. Those guidelines are consistent with the safety standard previously set by both U.S. and international standards bodies. The design of this device complies with the FCC guidelines and these international standards.

BODY-WORN OPERATION

Your **Mogul** smart device was tested for typical body-worn operations with the back of the device kept 1.5 cm from the body. To comply with FCC RF exposure requirements, a minimum separation distance of 1.5 cm must be maintained between the user's body and the back of the device, including the antenna. Third-party belt-clips, holsters and similar accessories containing metallic components should not be used. Body-worn accessories that cannot maintain 1.5 cm separation distance between the user's body and the back of the device, and have not been tested for typical body-worn operations may not comply with FCC RF exposure limits and should be avoided.

When carrying the device on you, turning the display in towards the body will minimize RF exposure and maximize antenna efficiency.

Modifications

The FCC requires the user to be notified that any changes or modifications made to the device that are not expressly approved by High Tech Computer Corporation may void the user's authority to operate the equipment.

FCC Hearing-Aid Compatibility (HAC) Regulations for Wireless Devices

On July 10, 2003, the U.S. Federal Communications Commission (FCC) Report and Order in WT Docket 01-309 modified the exception of wireless phones under the Hearing Aid Compatibility Act of 1988 (HAC Act) to require digital wireless phones be compatible with hearing-aids. The intent of the HAC Act is to ensure reasonable access to telecommunications services for persons with hearing disabilities.

While some wireless phones are used near some hearing devices (hearing aids and cochlear implants), users may detect a buzzing, humming, or whining noise. Some hearing devices are more immune than others to this interference noise, and phones also vary in the amount of interference they generate.

The wireless telephone industry has developed a rating system for wireless phones, to assist hearing device users find phones that may be compatible with their hearing devices. Not all phones have been rated. Phones that are rated have the rating on their box or a label located on the box.

The ratings are not guarantees. Results will vary depending on the user's hearing device and hearing loss. If your hearing device happens to be vulnerable to interference, you may not be able to use a rated phone successfully. Trying out the phone with your hearing device is the best way to evaluate it for your personal needs.

M-Ratings: Phones rated M3 or M4 meet FCC requirements and are likely to generate less interference to hearing devices than phones that are not labeled. M4 is the better/higher of the two ratings. **Mogul** is rated M3.

Hearing devices may also be rated. Your hearing device manufacturer or hearing health professional may help you find this rating. Higher ratings mean that the hearing device is relatively immune to interference noise. The hearing aid and wireless phone rating values are then added together. A sum of 5 is considered acceptable for normal use. A sum of 6 is considered for best use.

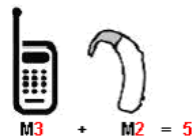

In the above example, if a hearing aid meets the M2 level rating and the wireless phone meets the M3 level rating, the sum of the two values equal M5. This should provide the hearing aid user with “normal usage” while using their hearing aid with the particular wireless phone. “Normal usage” in this context is defined as a signal quality that is acceptable for normal operation.

The M mark is intended to be synonymous with the U mark. The T mark is intended to be synonymous with the UT mark. The M and T marks are recommended by the Alliance for Telecommunications Industries Solutions (ATIS). The U and UT marks are referenced in Section 20.19 of the FCC Rules. The HAC rating and measurement procedure are described in the American National Standards Institute (ANSI) C63.19 standard.

For information about hearing aids and digital wireless phones

FCC Hearing Aid Compatibility and Volume Control:

<http://www.fcc.gov/cgb/dro/hearing.html>

Gallaudet University, RERC:

<http://tap.gallaudet.edu/DigWireless.KS/DigWireless.htm>

SAR Information

SAR: 1.130 W/kg @1g (USA)

THIS MODEL DEVICE MEETS THE GOVERNMENT'S REQUIREMENTS FOR EXPOSURE TO RADIO WAVES.

For body-worn operation, this phone has been tested and meets the FCC RF exposure guidelines when used with the High Tech Computer Corp. accessories supplied or designated for this product. Use of other accessories may not ensure compliance with the FCC RF exposure guidelines.

Your wireless mobile CDMA phone is a radio transmitter and receiver. It is designed and manufactured not to exceed the emission limits for exposure to radio frequency (RF) energy set by the Federal Communications Commission of the U.S. Government. These limits are part of comprehensive guidelines and establish permitted levels of RF energy for the general population. The guidelines are based on the safety standards previously set by both U.S. and international standards bodies:

- American National Standards Institute (ANSI) IEEE. C95.1-1992.
- National Council on Radiation Protection and Measurement (NCRP). Report 86. 1986.
- International Commission on Non-Ionizing Radiation Protection (ICNIRP) 1996.
- Ministry of Health (Canada), Safety Code 6. The standards include a substantial safety margin designed to assure the safety of all persons, regardless of age and health.

The exposure standard for wireless mobile CDMA phone employs a unit of measurement known as the Specific Absorption Rate, or SAR. The SAR limit set by the FCC is 1.6W/kg*. Tests for SAR are conducted with the device transmitting at its highest certified power level in all tested frequency bands. Although the SAR is determined at the highest certified power level, the actual SAR level of the device while operating can be well below the maximum value. This is because the device is designed to operate at multiple power levels so as to use only the power required to reach the network. In general, the closer you are to a wireless base station antenna, the lower the power output. Before a device model is available for sale to the public, it must be tested and certified to the FCC that it does not exceed the limit established by the government adopted requirement for safe exposure. The tests are performed in positions and locations (e.g., at the ear and worn on the body) as required by the FCC for each model.

The highest SAR value for this model device when tested for use at the ear is 1.130 W/Kg @ 1g and when worn on the body, as described in this user guide, is 0.922 W/Kg @ 1g. (Body-worn measurements differ among device models, depending upon available accessories and FCC requirements). While there may be differences between the SAR levels of various devices and at various positions, they all meet the government requirement for safe exposure.

The FCC has granted an Equipment Authorization for this model device with all reported SAR levels evaluated as in compliance with the FCC RF exposure guidelines. SAR information on this model device is on file with the FCC and can be found under the Display Grant section of <https://gulfoss2.fcc.gov/prod/oet/cf/eas/reports/GenericSearch.cfm> after searching on FCC ID: NM8TITA100. Additional information on Specific Absorption Rates (SAR) can be found on the Cellular Telecommunications & Internet Association (CTIA) Web site as <http://www.phonefacts.net>.

* In the U.S. and Canada, the SAR limit for mobile CDMA phone used by the public is 1.6 Watts/kg (W/kg) averaged over one gram of tissue. The standard incorporates a substantial margin of safety to give additional protection for the public and to account for any variations in usage.

Normal condition only to ensure the radiative performance and safety of the interference. As with other mobile radio transmitting equipment, users are advised that for satisfactory operation of the equipment and for the safety of personnel, it is recommended that no part of the human body be allowed to come too close to the antenna during operation of the equipment.

FCC Enhanced 911 (E911) Rules

BACKGROUND

The Federal Communications Commission (FCC) requires wireless carriers to transmit specific latitude and longitude location (Automatic Location Identification = ALI) information as well as “911” calls to Public Safety Answering Points (PSAPs) to identify the location of the caller in case of emergency.

Generally, the rules require that carriers identify an E911 caller’s location within 50 meters of the actual location for 67 percent of calls and within 150 meters of the actual location for 95 percent of calls.

Mogul’s ALI CAPABILITY

The **Mogul** is an ALI-capable smart device equipped with a GPS (Global Positioning System) receiver supporting a satellite-based GPS ALI-capable network to comply with the FCC’s ALI requirements.

The network compliance with the above FCC requirements is dependent on: (a) the use of digital technology by the wireless network; (b) GPS satellite signals being able to reach the handset (such transmissions do not always work indoors, for example) ; and (c) handset signals reaching wireless “base stations” (atmospheric and environmental conditions may cause variations in handset receiving signal strength).

Also the transmission of the ALI information is subject, in part, to system constraints within the wireless network to which the E911 signal is transmitted and over which UT Starcom has no control.

Finally, customers are advised that the **Mogul’s** ALI capability is to be used for E911 purposes only.

For more information about placing emergency calls, see Section 3.

Compliance with Other FCC Regulations

OPERATING PROCEDURES

Never violate any of the following Rules and Regulations of the FCC when using your device. Such violations are punishable by fine, imprisonment or both.

- Never use obscene, indecent, or profane language.
- Never use your device to send false distress calls.
- Never wiretap or otherwise intercept a phone call, unless you have first obtained the consent of the parties participating in the call.
- Never make any anonymous calls to annoy, harass, or molest other people.
- Never charge another account without authorization, to avoid payment for service.
- Never willfully or maliciously interfere with any other radio communications.
- Never refuse to yield the line when informed that it is needed for an Emergency Call. Also, never take over a line by stating falsely that it is needed for an emergency.

IC Statement

Operation is subject to the following two conditions:

1. This device may not cause interference; and
2. This device must accept any interference, including interference that may cause undesired operation of the device.

Important Note

IC Radiation Statement:

This equipment complies with IC radiation exposure limits set forth for an uncontrolled environment. End users must follow the specific operating instructions for satisfying RF exposure compliance.

This Class B digital apparatus complies with Canadian ICES-003.

WEEE Notice

The Directive on Waste Electrical and Electronic Equipment (WEEE), which entered into force as European law on 13th February 2003, resulted in a major change in the treatment of electrical equipment at end-of-life.

The purpose of this Directive is, as a first priority, the prevention of WEEE, and in addition, to promote the reuse, recycling and other forms of recovery of such wastes so as to reduce disposal.



The WEEE logo (shown at the left) on the product or on its box indicates that this product must not be disposed of or dumped with your other household waste. You are liable to dispose of all your electronic or electrical waste equipment by relocating over to the specified collection point for recycling of such hazardous waste. Isolated collection and proper recovery of your electronic and electrical waste equipment at the time of disposal will allow us to help conserving natural resources. Moreover, proper recycling of the electronic and electrical waste equipment will ensure safety of human health and environment. For more information about electronic and electrical waste equipment disposal, recovery, and collection points, please contact your local city center, household waste disposal service, shop from where you purchased the equipment, or manufacturer of the equipment.

RoHS Compliance

This product is in compliance with Directive 2002/95/EC of the European Parliament and of the Council of 27 January 2003, on the restriction of the use of certain hazardous substances in electrical and electronic equipment (RoHS) and its amendments.

Important Health Information and Safety Precautions

When using this product, the safety precautions below must be taken to avoid possible legal liabilities and damages. Additional safety information can be found in the Appendix at the end of the user manual.

Retain and follow all product safety and operating instructions. Observe all warnings in the operating instructions on the product.

To reduce the risk of bodily injury, electric shock, fire, and damage to the equipment, observe the following precautions.

ELECTRICAL SAFETY

This product is intended for use when supplied with power from the designated battery or power supply unit. Other usage may be dangerous and will invalidate any approval given to this product.

SAFETY PRECAUTIONS FOR PROPER GROUNDING INSTALLATION

CAUTION: Connecting to an improperly grounded equipment can result in an electric shock to your device.

This product is equipped with a USB Sync cable for connecting the product to a desktop or notebook computer. Be sure your computer is properly grounded (earthed) before connecting the product to the computer. The power supply cord of a desktop or notebook computer has an equipment-grounding conductor and a grounding plug. The plug must be plugged into an appropriate outlet which is properly installed and grounded in accordance with all local codes and ordinances.

SAFETY PRECAUTIONS FOR POWER SUPPLY UNIT

- **Use the correct external power source**

A product should be operated only from the type of power source indicated on the electrical ratings label. If you are not sure of the type of power source required, consult your authorized service provider or local power company. For a product that operates from battery power or other sources, refer to the operating instructions that are included with the product.

- **Handle battery packs carefully**

This product contains a Li-Ion Polymer battery. There is a risk of fire and burns if the battery pack is handled improperly. Do not attempt to open or service the battery pack. Do not disassemble, crush, puncture, short external contacts or circuits, dispose of in fire or water, or expose a battery pack to temperatures higher than 60°C (140°F).



WARNING: Danger of explosion if battery is incorrectly replaced. To reduce risk of fire or burns, do not disassemble, crush, puncture, short external contacts, expose to temperature above 60°C (140°F), or dispose of in fire or water. Replace only with specified batteries. Recycle or dispose of used batteries according to the local regulations or reference guide supplied with your product.



SAFETY PRECAUTIONS FOR DIRECT SUNLIGHT

Keep this product away from excessive moisture and extreme temperatures. Do not leave the product or its battery inside a vehicle or in places where the temperature may exceed 60°C (140°F), such as on a car dashboard, window sill, or behind a glass that is exposed to direct sunlight or strong ultraviolet light for extended periods of time. This may damage the product, overheat the battery, or pose a risk to the vehicle.

PREVENTION OF HEARING LOSS

CAUTION: Permanent hearing loss may occur if earphones or headphones are used at high volume for prolonged periods of time.

Turn down the volume before using headphones or other audio devices. An excessive sound volume level could cause damage to your hearing.

SAFETY IN AIRCRAFT

Due to the possible interference caused by this product to an aircraft's navigation system and its communications network, using this device's phone function on board an airplane is against the law in most countries. If you want to use this device when on board an aircraft, remember to turn off the phone by switching to Flight Mode.

EXPLOSIVE ATMOSPHERES

When in any area with a potentially explosive atmosphere or where flammable materials exist, the product should be turned off and the user should obey all signs and instructions. Sparks in such areas could cause an explosion or fire resulting in bodily injury or even death. Users are advised not to use the equipment at refueling points such as service or gas stations, and are reminded of the need to observe restrictions on the use of radio equipment in fuel depots, chemical plants, or where blasting operations are in progress. Areas with a potentially explosive atmosphere are often, but not always, clearly marked. These include fueling areas, below deck on boats, fuel or chemical transfer or storage facilities, and areas where the air contains chemicals or particles, such as grain, dust, or metal powders.

ROAD SAFETY

Vehicle drivers in motion are not permitted to use telephony services with handheld devices, except in the case of emergency. In some countries, using hands-free devices as an alternative is allowed.

SAFETY PRECAUTIONS FOR RADIO FREQUENCY (RF) EXPOSURE

- Avoid using your device near metal structures (for example, the steel frame of a building).
- Avoid using your device near strong electromagnetic sources, such as microwave ovens, sound speakers, TV and radio.
- Use only original manufacturer-approved accessories, or accessories that do not contain any metal.
- Use of non-original manufacturer-approved accessories may violate your local RF exposure guidelines and should be avoided.

INTERFERENCE WITH MEDICAL EQUIPMENT FUNCTIONS

This product may cause medical equipment to malfunction. The use of this device is forbidden in most hospitals and medical clinics.

If you use any other personal medical device, consult the manufacturer of your device to determine if it is adequately shielded from external RF energy. Your physician may be able to assist you in obtaining this information.

Turn the phone off in health care facilities when any regulations posted in these areas instruct you to do so. Hospitals or health care facilities may be using equipment that could be sensitive to external RF energy.

HEARING AIDS

Some digital wireless phones may interfere with some hearing aids. In the event of such interference, you may want to consult your service provider, or call the customer service line to discuss alternatives.

NONIONIZING RADIATION

This product should be operated in the suggested normal condition only to ensure the radiative performance and safety of the interference. As with other mobile radio transmitting equipment, users are advised that for satisfactory operation of the equipment and for the safety of personnel, it is recommended that no part of the human body be allowed to come too close to the antenna during operation of the equipment.

GENERAL PRECAUTIONS

- **Heed service markings**
Except as explained elsewhere in the operating or service documentation, do not service any product yourself. Service needed on components inside the device should be done by an authorized service technician or provider.
 - **Damage requiring service**
Unplug the product from the electrical outlet and refer servicing to an authorized service technician or provider under the following conditions:
 - Liquid has been spilled or an object has fallen into the product.
 - The product has been exposed to rain or water.
 - The product has been dropped or damaged.
 - There are noticeable signs of overheating.
 - The product does not operate normally when you follow the operating instructions.
 - **Avoid hot areas**
The product should be placed away from heat sources such as radiators, heat registers, stoves, or other products (including, but not limited to, amplifiers) that produce heat.
 - **Avoid wet areas**
Never use the product in a wet location.
 - **Avoid using your device after a dramatic change in temperature**
When you move your device between environments with very different temperature and/or humidity ranges, condensation may form on or within the device. To avoid damaging the device, allow sufficient time for the moisture to evaporate before using the device.
- | | |
|--------------|--|
| Note: | When taking the device from low-temperature conditions into a warmer environment or from high-temperature conditions into a cooler environment, allow the device to acclimate to room temperature before turning on the power. |
|--------------|--|
- **Avoid pushing objects into product**
Never push objects of any kind into cabinet slots or other openings in the product. Slots and openings are provided for ventilation. These openings must not be blocked or covered.
 - **Mounting accessories**
Do not use the product on an unstable table, cart, stand, tripod, or bracket. Any mounting of the product should follow the manufacturer's instructions, and should use a mounting accessory recommended by the manufacturer.
 - **Avoid unstable mounting**
Do not place the product with an unstable base.
 - **Use product with approved equipment**
This product should be used only with personal computers and options identified as suitable for use with your equipment.
 - **Cleaning**
Unplug the product from the wall outlet before cleaning. Do not use liquid cleaners or aerosol cleaners. Use a damp cloth for cleaning, but NEVER use water to clean the LCD screen.

A.3 Additional Safety Information

This section provides more safety information in addition to the information at the beginning of the user manual.

When Driving

Do Not Use The PC Functions Of Your Smart Device While Driving Or Walking

Never use the personal computer functions of your device while driving an automobile or any other moving vehicle. Always pull out of traffic and come to a stop in a legally permissible and safe location before using your device. Failure to do so could result in serious bodily injury in a traffic accident.

When driving:

- Always secure your device in its leather pouch.
- Never place your device on the passenger seat or anyplace else in the car where it can become a projectile during a collision or stop.
- An air bag inflates with great force. DO NOT place objects, including either installed or portable wireless equipment, in the area over the air bag or in the air bag deployment area. If in-vehicle wireless equipment is improperly installed and the air bag inflates, serious injury could result.

Never store or transport flammable liquids, flammable gases, or explosive materials in the same compartment of your automobile as the device or any of its accessories, as possible sparking in the device could cause ignition or explosion.

Never use your device while walking. Usage while walking could result in bodily injury caused by inattention to automobile traffic or other pedestrian hazards.

Using The Phone Function Of Your Smart Device While Driving Is Extremely Dangerous

Talking on or using your smart device's phone while driving is extremely dangerous and is illegal in some states. Remember, safety comes first. Check the laws and regulations on the use of phones in the areas where you drive. Always obey them.

If you must use the phone function while driving, please:

- Give full attention to driving. Driving safely is your first responsibility.
- Use hands-free operation and/or one-touch, speed dialing, and auto answer modes.
- Pull off the road and park before making or answering a call.

WARNING: Failure to follow these instructions could lead to serious personal injury and possible property damage.

When Using Your Device Near Other Electronic Devices

Your wireless handheld portable pocket PC phone is a low power radio transmitter and receiver. When it is ON, it receives and also sends out radio frequency (RF) signals.

Most modern electronic equipment is shielded from RF energy. However, certain electronic equipment may not be shielded against the RF signals from your wireless pocket PC phone; therefore, use of your pocket PC phone must be restricted in certain situations.

In addition, the computer portion of your device produces low levels of RF energy due to the generation of digital timing pulses by its clock oscillator circuits. Your device has been equipped with internal shielding to minimize stray emissions of RF energy. However, use of the computer functions of your device must be restricted in certain situations.

PACEMAKERS

The Health Industry Manufacturers Association recommends that a minimum separation of six (6) inches be maintained between a handheld wireless phone and a pacemaker to avoid potential interference with the pacemaker. These recommendations are consistent with the independent research by and recommendations of Wireless Technology Research.

Never come closer than six (6) inches to a person with a heart pacemaker implant when using your device. Doing so could result in interference with the function of the pacemaker.

Persons with pacemakers:

- Should ALWAYS keep the phone more than six inches from their pacemaker when the phone is turned ON.
- Should not carry the phone in a breast pocket.
- Should use the ear opposite the pacemaker to minimize the potential for interference.

Note:

This is not necessary if the smart device's phone is not held to the ear.

- If you have any reason to suspect that interference is taking place, turn the phone OFF immediately.

HEARING AIDS

Some digital wireless phones may interfere with some hearing aids. In the event of such interference, you may want to consult your service provider, or call the customer service line to discuss alternatives.

For more regulatory information about hearing devices, see "FCC Hearing-Aid Compatibility (HAC) Regulations for Wireless Devices."

OTHER MEDICAL DEVICES

If you use any other personal medical device, consult the manufacturer of your device to determine if it is adequately shielded from external RF energy. Your physician may be able to assist you in obtaining this information.

HOSPITALS AND HEALTH CARE FACILITIES

Turn your device OFF in health care facilities when any regulations posted in these areas instruct you to do so. Hospitals or health care facilities may be using equipment that could be sensitive to external RF energy.

ELECTRONIC DEVICES IN VEHICLES

RF signals may affect improperly installed or inadequately shielded electronic systems in motor vehicles. Check with the manufacturer or its representative regarding your vehicle. You should also consult the manufacturer of any equipment that has been added to your vehicle.

POSTED FACILITIES

Turn your device OFF where posted notices so require.

Turn Off Your Device Before Flying

AIRCRAFT

FCC regulations prohibit using the transmitting and phone functions of your device while in the air. In addition, most airline regulations prohibit the on-board use of portable PCs (and all other portable electronic devices that could potentially emit stray RF energy), particularly during take-offs and landings, to prevent any possible interference with the reception of signals by airborne electronic navigational devices.

Turn your device OFF before boarding an aircraft. Always request and obtain prior consent and approval of an authorized airline representative before using your device aboard an aircraft. Always follow the instructions of the airline representative whenever using your device aboard an aircraft, to prevent any possible interference with airborne electronic equipment.

Turn Off Your Device in Dangerous Areas

BLASTING AREAS

To avoid interfering with blasting operations, turn your device OFF when in a “blasting area” or in areas posted “Turn off two-way radio.” Obey all signs and instructions.

POTENTIALLY EXPLOSIVE ATMOSPHERES

Turn your device OFF when in any area with a potentially explosive atmosphere and obey all signs and instructions. Sparks in such areas could cause an explosion or fire resulting in bodily injury or even death.

Areas with a potentially explosive atmosphere are often, but not always, clearly marked. They include fueling areas such as gas stations; below deck on boats; fuel or chemical transfer or storage facilities; vehicles using liquefied petroleum gas (such as propane or butane); areas where the air contains chemicals or articles, such as grain, dust, or metal powders; and any other area where you would normally be advised to turn off your vehicle's engine.

General Safety

Your pocket PC is a high quality piece of equipment. Before operating, read all instructions and cautionary markings on the product, battery and adapter/charger.

Failure to follow the directions below could result in serious bodily injury and/or property damage due to battery liquid leakage, fire or rupture.

DO NOT use or store this equipment in a place where it will be exposed to high temperatures, such as near an open flame or heat-emitting equipment.

DO NOT drop your device or subject it to severe shock. When not using, lay down the unit to avoid possible damage due to instability.

DO NOT expose this equipment to rain or spilled beverages.

DO NOT use unauthorized accessories.

DO NOT disassemble the device or its accessories. If service or repair is required, return unit to an authorized UT Starcom cellular service center. If the unit is disassembled, the risk of electric shock or fire may result.

Never allow metallic objects, such as staples and paper clips, to get into the inside of your device.

Never touch the liquid that might leak from a broken liquid crystal display. Contact with this liquid could cause a skin rash. If the crystal display liquid should come into contact with the skin or clothing, wash it immediately with clean water.

In the event that the device emits an unusual odor or sound or generates smoke, immediately disconnect the AC phone charger from the power outlet, and then remove the battery.

Antenna Safety

Use only the supplied or an approved replacement antenna. Unauthorized antennas, modifications, or attachments could impair call quality, damage your device, or result in violation of FCC regulations. Please contact your local dealer for replacement antenna.

Do not use the device with a damaged antenna. If a damaged antenna comes into contact with the skin, a minor burn may result. Please contact your local dealer for replacement antenna.

Battery Safety

Your device uses a removable and rechargeable lithium ion battery. Please contact customer service for assistance should you need a replacement battery.

DOs

- Only use the battery and charger approved by the manufacturer.
- Only use the battery for its original purpose.
- Try to keep batteries in a temperature between 41°F (5°C) and 95°F (35°C).
- If the battery is stored in temperatures above or below the recommended range, give it time to warm up or cool down before using.
- Completely drain the battery before recharging. It may take one to four days to completely drain.
- Store the discharged battery in a cool, dark, and dry place.
- Purchase a new battery when its operating time gradually decreases after fully charging.
- Properly dispose of the battery according to local regulations.

DON'Ts

- Don't attempt to disassemble the battery – it is a sealed unit with no serviceable parts.
- Don't expose the battery terminals to any other metal object (e.g., by carrying it in your pocket or purse with other metallic objects such as coins, clips and pens). This can short circuit and critically damage the battery.
- Don't leave the battery in hot or cold temps. Otherwise, it could significantly reduce the capacity and lifetime of the battery.
- Don't dispose of the battery into a fire.

Lithium-ion batteries are recyclable. When you replace the removable battery, please request the repair center to recycle the battery in accordance with RBRC standards. When disposing of the battery by yourself, please call RBRC at (800) 822-8837 for proper disposal tips.

Never touch any fluid that might leak from the built-in battery. Such liquid when in contact with the eyes or skin, could cause injury to the skin or eyes. Should the liquid come into contact with the eyes, irrigate the eyes thoroughly with clean water and immediately seek medical attention. In the event the liquid comes into contact with the skin or clothing, wash it away immediately with clean water.

AC Phone Charger

Use the Correct External Power Source

A product should be operated only from the type of power source indicated on the electrical ratings label. If you are not sure of the type of power source required, consult your authorized service provider or local power company. For a product that operates from battery power or other sources, refer to the operating instructions that are included with the product.

The AC phone charger designed by UT Starcom for this unit requires the use of a standard 120 V AC power source for device operation.

Never attempt to disassemble or repair an AC phone charger. Never use an AC phone charger if it has a damaged or worn power cord or plug. Always contact a UT Starcom authorized service center, if repair or replacement is required.

Never alter the AC cord or plug on an AC phone charger. If the plug will not fit into the available outlet, have a proper outlet installed by a qualified electrician.

Never allow any liquids or water to spill on an AC phone charger when it is connected to an AC power source.

Always use the authorized UT Starcom AC phone charger to avoid any risk of bodily injury or damage to your cellular phone or battery.

Never attempt to connect or disconnect the AC phone charger with wet hands. Always unplug the AC phone charger from the power source before attempting any cleaning. Always use a soft cloth dampened with water to clean the equipment, after it has been unplugged.

Handling the cord on this product or cords associated with accessories sold with this product, will expose you to lead, a chemical known to the State of California to cause birth defects or other reproductive harm. Wash hands after handling.

Always disconnect the travel charger or desktop charger from the power source when it is not in use.

Index



A

- About licenses and protected media 152
- ActiveSync
 - overview 19
- Add and remove programs 158
- Adobe Reader LE
 - overview 19
 - use 117
- Appointment 78
- Assign pictures to contacts 150

B

- Battery
 - battery information 12
 - charge battery 12
 - install battery 12
 - save battery power 126
- Beam
 - via infrared 149
- Block Recognizer 28
- Bluetooth
 - beam 132
 - create partnership 131
 - hands-free headset 132
 - overview 130
 - stereo headset 132
 - turn on/off 130
- Burst capture mode 138
- Button controls and LEDs 173

C

- Calculator 19
- Calendar 78
- Calibrate 14
- Call
 - from Call History 35
 - from Contacts 35
 - from Phone 35
 - Speed Dial 36
- Call Forwarding 40
- Camera
 - capture modes 138
 - controls 139
 - file formats 139
 - icons 139
 - overview 19
 - settings 144
 - specifications 172
- Clock & Alarms 21
- Comm Manager 22
- Conference call 41
- Connection
 - connect to Internet 125
 - connect to private network 128

- Contacts 76
- Contacts Picture capture mode 138
- Copy
 - pictures and video clips from PC to device 147

D

- Delete pictures and videos 148
- Digital Rights Management (DRM) 152
- Dimensions and weight 172

E

- Edit picture 149
- Excel Mobile 19

F

- File Explorer 19

G

- Games 19
- GIF animation 147

H

- Handwriting 29
- Hardware keyboard 24
- Help 3, 19

I

- In-call options 41
- Indicators 17
- Infrared (IR)
 - beam picture or video 149
- Input methods
 - Symbol Pad 30
- Input Panel 25
- Internet Explorer Mobile 129
 - overview 19
- Internet Sharing 19

J

- Java
 - create folders 167
 - install MIDlets/MIDlet suites from device 166
 - install MIDlets/MIDlet suites from Internet 166
 - manage MIDlets/MIDlet suites 167
 - move MIDlet to another folder 167
 - rename MIDlet or folder 167
 - set MIDlet permission settings 167
 - uninstall MIDlets 167
 - update a MIDlet/MIDlet suite 167

K

Keyboard

- hardware keyboard 24
- onscreen keyboard 26

Keypad tone 43

L

Letter Recognizer 27

Library screen (Windows Media Player Mobile) 152

Live Messenger 110

- personalize 112
- send instant messages 111

M

Memory 172

Messaging

- overview 20

MIDlet/MIDlet suite 166

N

Network settings 128

Notes 19, 31, 82

Now Playing screen (Windows Media Player Mobile) 152

O

Onscreen keyboard 26

Open PDF file 117

P

Panorama capture mode 138

PDF 117

Phone 19

Phone settings 43

Pictures & Videos

- assign pictures to contacts 150
- delete 148
- edit picture 149
- file formats 147
- overview 20
- play GIF animation 147
- play videos 148
- sort 148
- view pictures 147
- view slideshows 148

Picture Theme capture mode 138

Playback screen (Windows Media Player Mobile) 152

Playlists 154

Play GIF animation 147

Play media 153

Play videos 148

PowerPoint Mobile 19

Programs

- ActiveSync 19
- Adobe Reader LE 19, 117
- AudiblePlayer 19
- Calculator 19
- Camera 19, 138
- Comm Manager 22
- Excel Mobile 19
- File Explorer 19
- Games 19
- GetGood 19
- Help 19
- Internet Explorer Mobile 19
- Internet Sharing 19
- Java 19, 166
- Messaging 20
- Messenger 20
- Notes 19
- On Demand 19
- Phone 19
- Pictures & Videos 20, 147
- PowerPoint Mobile 19
- Search 20
- Software Store 20
- Tasks 20
- Voice SpeedDial Switch 20
- Voice Speed Dial 20, 169
- Windows Live 20
- Windows Media Player Mobile 20, 151
- Word Mobile 19
- ZIP 20, 121

R

Regulatory notices 174

Reset device 162

Review screen (Camera) 142

Ring tone 43

Ring type 43

S

Search 20

Search information 32

Send pictures and videos via email 149

Settings (Connections tab)

- Beam 22
- Bluetooth 22
- Connections 22
- USB to PC 22
- Wi-Fi 22
- Wireless LAN 22

Settings (Personal tab)

- Buttons 21
- Input 21
- Lock 21
- Menus 21

- Owner Information 21
- Phone 21
- Sounds & Notifications 21
- Today 21

Settings (System tab)

- About 21
- Backlight 21
- Certificates 21
- Clear Storage 21
- Clock & Alarms 21
- Customer Feedback 21
- Device Information 21
- Encryption 21
- Error Reporting 22
- Key Lock 22
- Memory 22
- Power 22
- Regional Settings 22
- Remove Programs 22
- Screen 22

Set picture as Today screen background 149

Shortcuts 65

Sliding keyboard 24

Smart Dialing 38

Specifications 172

Sports capture mode 138

Start up 14

Still image capture modes 141

Storage card 32

Symbol Pad 30

System information 172

T

Tasks 20, 80

Text size 64

Transcriber 29

Troubleshoot Windows Media Player 154

U

USB modem 134

V

Video capture mode 141

View

- photo slideshows 148
- pictures 147

Voice mail 36

Voice Speed Dial

- overview 20, 169

Voice tags

- create for phone numbers 169
- create for programs 169
- use 170

W

Windows Live 108

- interface 108
- Live Search Bar 109
- set up 108

Windows Media Player Mobile

- file formats 151
- menus 152
- overview 20
- playlists 154
- troubleshoot 154

Word Mobile 19

Z

ZIP

- create archive 121
- open zip file and extract files 121
- overview 20, 121

Zoom (Camera) 143

Free Manuals Download Website

<http://myh66.com>

<http://usermanuals.us>

<http://www.somanuals.com>

<http://www.4manuals.cc>

<http://www.manual-lib.com>

<http://www.404manual.com>

<http://www.luxmanual.com>

<http://aubethermostatmanual.com>

Golf course search by state

<http://golfingnear.com>

Email search by domain

<http://emailbydomain.com>

Auto manuals search

<http://auto.somanuals.com>

TV manuals search

<http://tv.somanuals.com>