

---

Service Manual  
for PDA PHONE II  
Andes

---

HTC Proprietary  
Confidential Treatment Requested

**Rev. 2.0**  
Jan 5 , 2005

**HTC Corp.**  
*Engineering Mobility*

## TITLE: Service Manual for PDA PHONE II

REV. NO.	DATE	CONTENTS	DEP.	REVISED	APP'D	STGE.PER.
1.0	Oct 06,2003		TSD	Henry_Lai		
1.5	Oct 13,2003		TSD	Henry_Lai		
1.6	Oct 20,2003		TSD	Henry_Lai		
1.7	Nov 07,2003		TSD	Henry_Lai		
1.8	Dec 22,2003		TSD	Henry_Lai		
1.9	2004/6/3	Camera defect to lead to audio function( P64)	TSD	HB_Chen		
2.0	2005/1/26	Leakage current measurement	TSD	HB_Chen		

## Table of contents

1. INTRODUCTION.....	5
2. PRODUCT SPECIFICATIONS.....	5
2.1 PRODUCT CONFIGURATION.....	5
2.2 SPECIFICATIONS OF PDA PHONE II .....	6
2.3 SPECIFICATIONS OF AC ADAPTER .....	6
2.4 GSM/GPRS FUNCTIONAL BLOCK PART .....	6
3. SYSTEM BLOCK DIAGRAM .....	11
4. LABELING .....	12
5. SERVICING TOOLS .....	14
6. ASSEMBLING AND DISASSEMBLING .....	15
6.1 DISASSEMBLING.....	15
6.2 ASSEMBLING.....	22
6.3 Camera Replacement assembly .....	29
6.4 Connector, Back up battery replacement .....	30
7. PROBLEM DIAGNOSTICS.....	31
7.1 LIST OF TEST JIGS .....	31
7.2 H/W REQUIREMENT FOR PC.....	31
7.3 SOFTWARE REQUIREMENT .....	31
8. DIAGNOSTIC PROGRAMS .....	32
8.1 LIST OF TEST ITEMS .....	32
8.2 TEST ITEMS OPERATION .....	32
9. BATTERY TEST/JUDGEMENT PROCEDURE .....	36
10.LCM INSPECTION CRITERIA .....	41
11.RF .....	43
11.1 RF TEST REQUIREMENT.....	43
11.2 RF TEST PICTURE .....	43
11.3 RF ANTENNA TEST SPEC. ....	44
12. OS UPGRADE AND GSM CODE UPGRADE .....	46
12.1 RUU.....	47
12.2 RSU .....	47
12.3 COMPLETE PROCEDURE FOR SD REFLASH .....	51
12.4 Procedure for Unit Re-flash .....	56
13. CLASSIFICATION OF NON CONFIRMITY .....	58
14.TROUBLE SHOOTING AND REPAIR .....	59
15 EXPLODED DIAGRAMS& SPARE PART LIST .....	65

15.1 Exploded Diagrams.....	65
15.2 LIST OF SPAR PARTS.....	66
15.3 Spare Parts list with picture	67
<b>14.APPENDIX.....</b>	<b>70</b>
A. CUSTOMER, RETAILER MISJUDGMENT .....	70
B. Repair Trouble Shooting Guide	73
4END .....	73

## 1. Introduction

This manual provides the technical information to support the service activities of the PDA PHONE II.

This document contains highly confidential information, so any or all of this document should not be revealed to any third party.

## 2. Product Specifications

### 2.1 Product Configuration

#### Standard Package

ITEM	CONTAINS
1	Main Unit
2	USB Cradle
3	Stylus
4	AC Adapter
5	Earphone
6	Pouch, Leather Case
7	Service Kit
8	Quick Start Guide
9	User's Manual
10	Battery Pack

## 2.2 Specifications of PDA PHONE II

Item	Specification
Platform	<ul style="list-style-type: none"> <li>● Microsoft Pocket PC 2003 phone edition - English, French, German, Italian, Spanish, Portuguese.</li> <li>● Combined GSM/GPRS and PDA.</li> <li>● 2 logical block (PDA and GSM/GPRS) solution, layout is integrated into one module</li> <li>● GSM/GPRS can be turned off to let PDA to run alone</li> </ul>
Outside Dimensions	● 69.9mm(W) x 130mm(H) x 19mm (T)
Weight	● 190g
Battery	<ul style="list-style-type: none"> <li>● Removable rechargeable Lithium Polymer battery</li> <li>● 1200 mAh (Typical)</li> <li>● Data retention time : 72 hrs</li> <li>● Separated Back up battery(25 mAh,rechargeable), data retention time above 0.5 hrs</li> <li>● Battery Life : 15 hrs of PDA</li> <li>● Talk time : 2.5 ~ 4 hrs</li> <li>● Standby : 180 hrs</li> </ul>

## 2.3 Specification of AC Adapter

AC Adapter	<ul style="list-style-type: none"> <li>● AC input 100 ~ 240 Vac, 50/60 HZ</li> <li>● AC input current : 0.2 A max</li> <li>● Output voltage : 5V dc</li> <li>● Output current : 2A (typical)</li> </ul>
------------	---

## 2.4 GSM/GPRS Functional Block

GPRS/GSM (Tri-band) module	<ul style="list-style-type: none"> <li>● GSM900: 880-915, 925-960MHz</li> <li>● DCS1800 1710 ~ 1785, 1805 ~ 1880 MHz</li> <li>● PCS1900 1850 ~ 1910, 1930 ~ 1990MHz</li> </ul>
Antenna Generic GSM Service	<ul style="list-style-type: none"> <li>● Internal Antenna</li> <li>● Call forwarding</li> <li>● Explicit Call Transfer</li> <li>● Spool Icon</li> <li>● Wave ring tone download /compose</li> <li>● Long message (640 characters)</li> <li>● SIM LOCK</li> <li>● Network lock</li> </ul>
GPRS functionality	<ul style="list-style-type: none"> <li>● GPRS Class B,</li> <li>● Multi-slot Class 10</li> </ul>
Memory FLASHROM	<ul style="list-style-type: none"> <li>● 64 MB</li> </ul>
SDRAM	<ul style="list-style-type: none"> <li>● 128MB</li> </ul>
SIM	<ul style="list-style-type: none"> <li>● 3V SIM Operation</li> </ul>
2.5 PDA Functional Block	
Processor	TI Calypso + IOTA, GSM/GPRS solution Intel PXA263 CPU (Low power, High Performance, 32 bit)
Clock Speed	<b>400MHz</b>
LCD Module	Transflective TFT-LCD with back light LEDs, 240 x 320 x 64K Sensitive Touch Screen
Graphic Controller	MPEG4 decoder 2D Graphic accelerator

Interface	<ul style="list-style-type: none"> <li>● One Infrared port IrDA SIR</li> <li>● One 22 pin individual Port for signals (for USB, Serial, Car Kit, Power and Audio)</li> <li>● One SIM card slot</li> <li>● One SDIO/MMC card slot (B-Square SDIO driver)</li> <li>● One 34 pin Back pack connector</li> <li>● One Audio Jack (2.5 <math>\phi</math>)</li> </ul>
Stylus	<ul style="list-style-type: none"> <li>● Lock type mechanism</li> </ul>
Keyboard/Button/Switch	<ul style="list-style-type: none"> <li>● One five way navigation button</li> <li>● One Power button(wake-up key)</li> <li>● One volume control button(up &amp; down)</li> <li>● Two phone button, SEND(Yes) &amp; END(No) (Wake-up keys),with LED backlight</li> <li>● Two programmable AP buttons(Wake up key)</li> <li>● Camera (Side button) Press to launch camera capture utility, and take picture for 2<sup>nd</sup> press</li> <li>● Voice command/Voice recorder (side button) <ul style="list-style-type: none"> <li>➤ Press for voice command</li> <li>➤ Press and hold for Voice recorder</li> </ul> </li> <li>● Reset Switch</li> <li>● Key lock function support by software</li> </ul>
Notification	<ul style="list-style-type: none"> <li>● One Bi-color LED for GSM standby, GSM message, GSM network status, PDA notification, PDA Charging status.</li> <li>● One Blue LED for Bluetooth system notification of powered –ON and ready to transmit RF signal.</li> <li>● Notification by sound, Message, Vibration on the display.</li> </ul>



Audio	<ul style="list-style-type: none"> <li>● Microphone build in</li> <li>● Software Echo cancellation</li> <li>● Receiver</li> <li>● Hardware AGC</li> <li>● Hardware Full duplex</li> <li>● WAV/WMA/MP3 stereo</li> <li>● 16 bits with 8KHz, 11 KHz, 16KHz, 22KHz, 44.1 KHz, 48 KHz sampling rate</li> </ul>
CMOS Camera	<ul style="list-style-type: none"> <li>● Color CMOS camera module</li> <li>● VGA (480x640) resolution with JPEG encoder</li> <li>● ALC (Auto Light Control)</li> <li>● AWB (Auto White Balance)</li> <li>● Preview Mirror on battery cover</li> <li>● Camcorder QCIF, 15 fps(min), (in live mode)( max 15 seconds per clip)</li> <li>● Operating in 5 Lux(Min)</li> </ul>
Cradle	<ul style="list-style-type: none"> <li>● Cradle connector connected to main unit</li> <li>● Audio jack (2.5 <math>\phi</math>)</li> <li>● Microphone</li> <li>● 2 slots, one for main unit + battery, another is capable of charging 2<sup>nd</sup> battery</li> <li>● Serial or USB cable between cradle and PC</li> <li>● LED indicator for 2<sup>nd</sup> battery charging</li> </ul>
Bluetooth	<ul style="list-style-type: none"> <li>● Bluetooth 1.1 compliant</li> <li>● Power class 2</li> <li>● Support Profile <ul style="list-style-type: none"> <li>➤ Generic access</li> <li>➤ Generic object Exchange</li> </ul> </li> </ul>

Accessories	<ul style="list-style-type: none"> <li>● Retractable sync. Cable (USB/Serial)</li> <li>● Cradle (USB, Serial)</li> <li>● AC adapter</li> <li>● Car adapter</li> <li>● Stylus</li> <li>● AC adapter with power plug</li> <li>● Detacheable LCD protector</li> <li>● Car Kit</li> <li>● Stereo wired headset with mono microphone, volume control, Pick up/Hang up the incoming/Outgoing call, Call waiting, conference call, microphone mute.</li> <li>● Mono Wired headset</li> <li>● Stereo Bluetooth headset</li> <li>● Option Battery (1200 mAh)</li> <li>● Keyboard</li> <li>● TTY Adaptor (Stereo &gt; Mono in audio jack)</li> <li>● Remote controller for VGA output</li> <li>● Back pack : CF + TV/VGA out (within cable) + 600 mAh battery</li> </ul> <p>CF Slot support</p> <ul style="list-style-type: none"> <li>➤ Wireless LAN</li> <li>➤ GPS CF card</li> <li>➤ Micro drive</li> <li>➤ CDMA CF Card</li> <li>➤ I/O card (Barcode reader,etc)</li> </ul>
Regulatory	<ul style="list-style-type: none"> <li>● PTCRB (For North America Market)</li> <li>● R&amp;TTE</li> <li>● FCC</li> <li>● USB V1.1 Compliance test</li> </ul>

### 3.SYSTEM BLOCK DIAGRAM

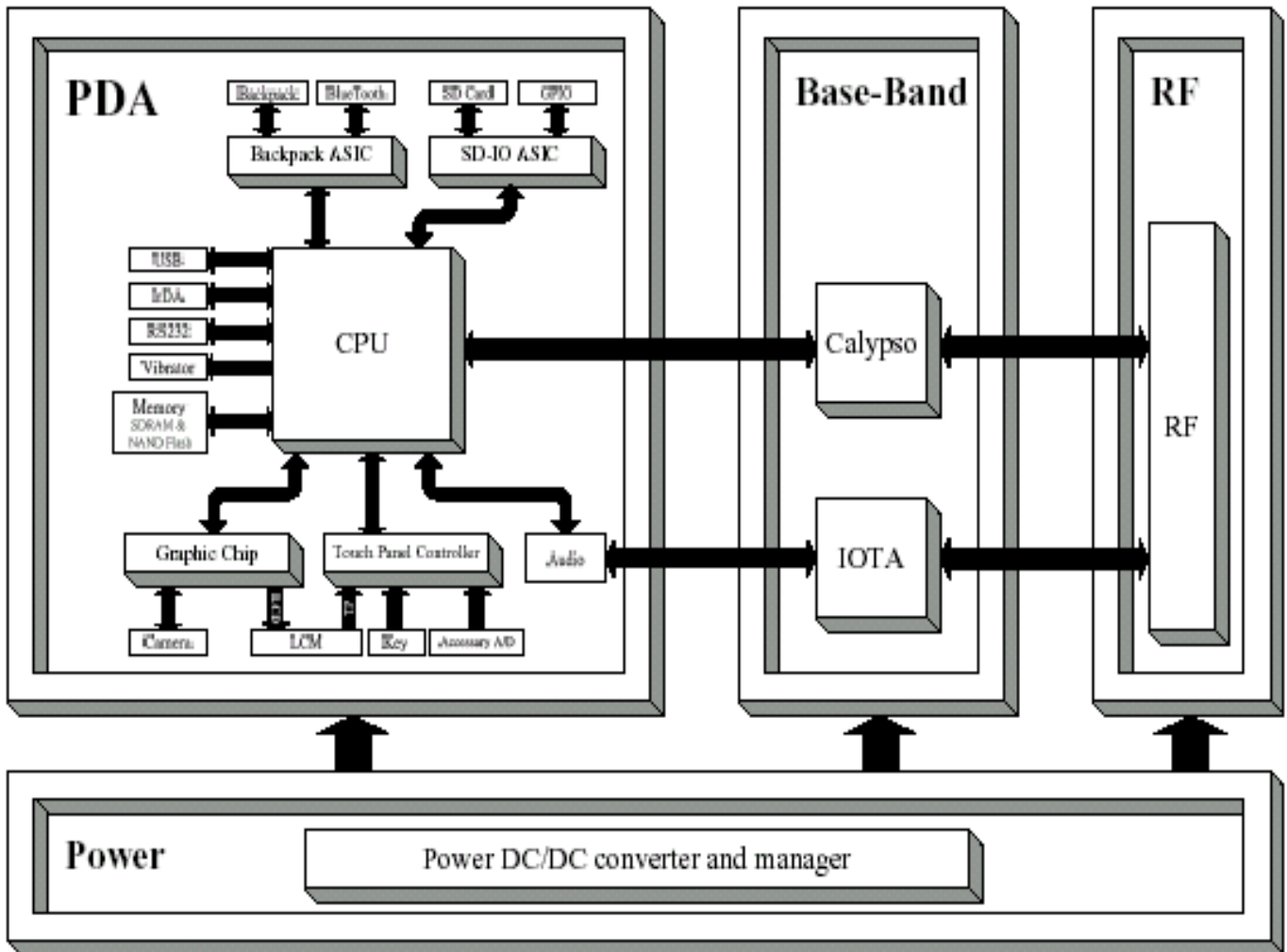

## 4. Labeling

### 4.1 Main unit *Regulatory label (on the rear housing of main unit)*

It includes

- ◆ Unit IMEI Number & Barcode
- ◆ Unit Serial Number & Barcode
- ◆ Simplified Part Number in Text

Image file name: Main\_UNIT\_REGULATION

Please note: 1. The brand name is shown on Bezel.

2. All bar codes must be code 128 symbology.

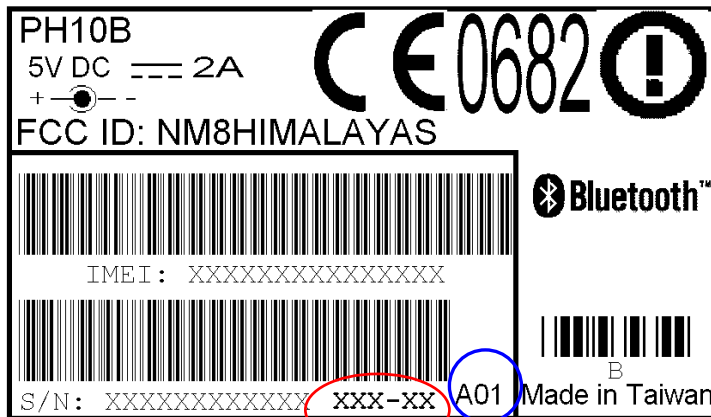
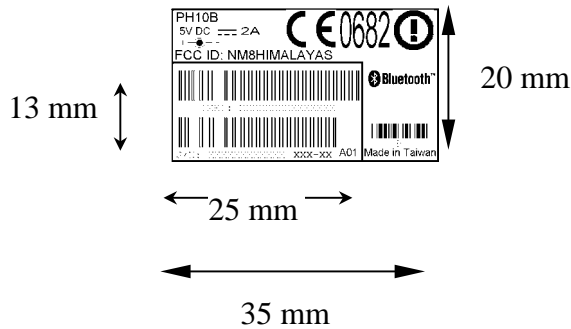

Simplified Part No.

System Rev.

Service Center is required to reprint the label in case of MB replacement with new IMEI no, or in case of housing replacement with unchanged Serial No and Part No.

## 4.2 Serial No description

For S/N: SSYWWPPZZZZZ

SS: SITE CODE --> HT

Y: Year Last Digital of the Year.

WW: Week Code : **01 ~ 54**

PP: Product Code : **TBD**

ZZZZZ: Serial Number (00001 ~ 99999) Use Base 10

For MODEL: PH10B is for label vendor's ID.

Label Characteristic :

Material: polyester

Color:pantone 422c

Ink:pantone 425c

Label example:



The Printing method is not much different to PDA Phone 1.

If you experienced with PDA phone 1, it almost same type, the attitude of label has been increased to 13 mm for easy printing.

---

HTC confidential

© 2001, HTC Corporation. All rights reserved.

TOTAL 77 CONT.ON. 14 PAGE NO. 13

## 5. Servicing Tools





This chapter provides information for the servicing tools for PDA PHONE II.

### List of Servicing Tools

No.	Item	Use	Remark
1	USB or Serial Cradle	Check for Cradle I/F (Serial communication only)	
2	USB DATA interface Cable	Check for Cradle I/F (USB communication only)	
3	Special Made Plastic Stick	Disassembling for	
4	SD Memory Card	For SD card test	
5	Earphone Headset	For Audio test.	
6	AC Adapter	Power supply to PDA PHONE II.	







## 6. Assembling and Disassembling

### 6.1 Disassembling

	<p>Tools needed for Assembling and Disassembling the <b>PDA PHONE II</b></p> <ol style="list-style-type: none"> <li>1. Lens Cleaning Tissue.</li> <li>2. Flat Screw Driver 2.4mm</li> <li>3. Philip Screw Driver #0.</li> <li>4. Torex Screw Driver T6X40</li> <li>5. Special Made Plastic Stick.</li> <li>6. Tweezers.</li> </ol>
	<p>Remove the Stylus, SD Card slot Filler, and the Car antenna connector cover.</p>
	<p>Next, Remove the Back cover by releasing the fixing lock as step 1. Then slightly push backward the back cover as step 2.</p>
	<p>Once Back cover is removed, you will find the battery on it.</p>

	<p>Press Unlock and release the battery</p>
	<p>Remove the battery from unit</p> <p> <b>Warning:</b> To reduce risk of fire or burns, do not disassemble, crush, puncture, short external contacts, or dispose of in fire or water. Replace only with specified batteries. Recycle or dispose of used batteries properly.</p> 
	<p>To separate the housing , Use the plastic stick to open the housing . Insert and gently twist into the gap between stylus hole and antenna cover.</p>
	<p>To separate the antenna cover, use the hook of plastic stick to release three hooks of antenna cover.</p>

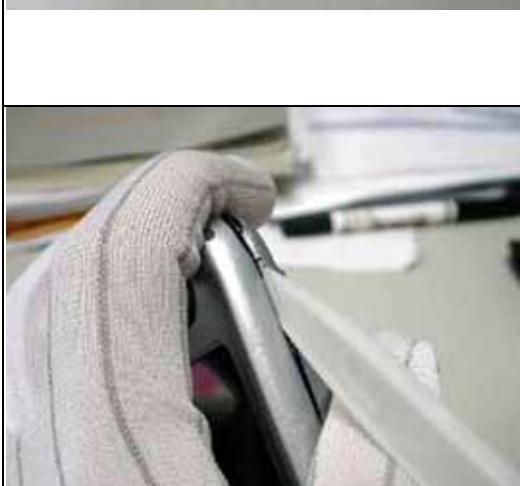

	<p>There are three hooks which fix the antenna cover and bezel. Insert to the gap and slightly pull upward from right to left to release the hooks.</p>
	<p>Antenna cover is removed. Remove two screws which fix the antenna to MB. Screw P/N:72H00339-00</p> 
	<p>Remove 6 screws which fixed the housing and bezel. There are two types of screw</p>  Screw 1~4 P/N 72H00338-00  Screw 5,6 P/N 72H00339-00
	<p>Now separating the housing. Use plastic stick to slide along the gap (Right side of unit, near stylus hole)</p>



Gently open the housing



Turn over the housing to the other side as shown on picture.

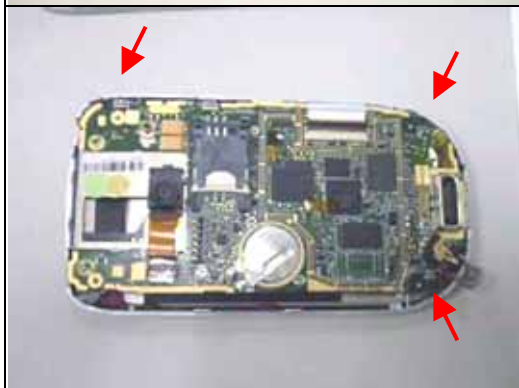

Once the housing is removed, next to remove 3 screws which fix the MB into bezel.



P/N 72H00401-00



Gently and carefully release the LCM FPC by litting the connector lock upward using your finger or soft plastic tweezers.



Then remove the Camera module by slightly releasing its FPC(1) and camera which is stuck with Double side tap on MB (2)

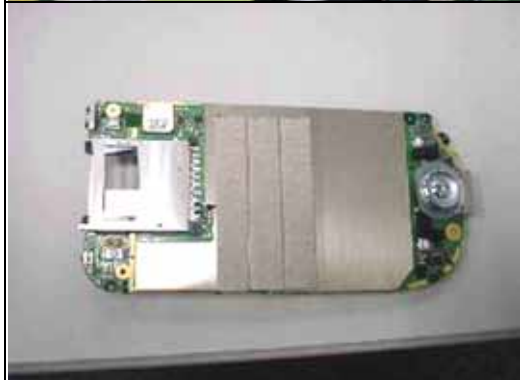

Turn MB to the other side and remove the Navigation button by pulling up.



Correct position of Navigation button



Use tweezers to remove the Vibrator



The LCM, Speaker , MIC is located on upper part (Bezel side).



Speaker

Before disassembly LCM, It is required to unscrew two screws of the speaker, and remove it from its place.

**P/N: 72H00401-00**

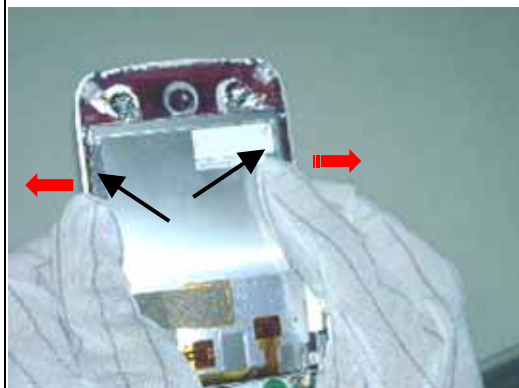

**To Disassembly LCM module**

Hold the entire assembly as seen on the picture , push aside the bezel and push the panel from front side simultaneously . Notice the starting location. Doing this to release the LCM from 4 hooks which located 2 at its right and left respectively.



Then, gently pull out the LCM from its lower part hook .



If MIC need to be replaced, just take it out from its place slightly by using tweezers.



Take out the MB and disassembly procedure is done.

The disassembly procedure is finished.

## 6.2 Assembling

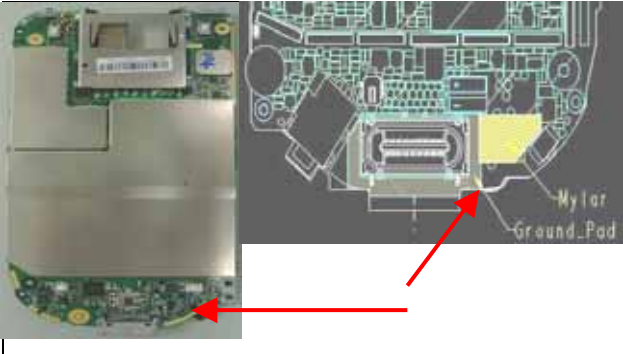
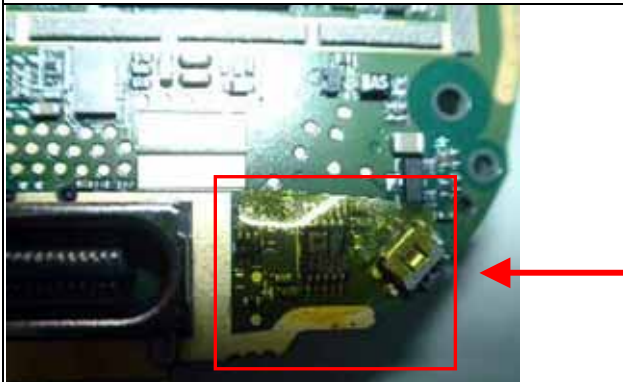
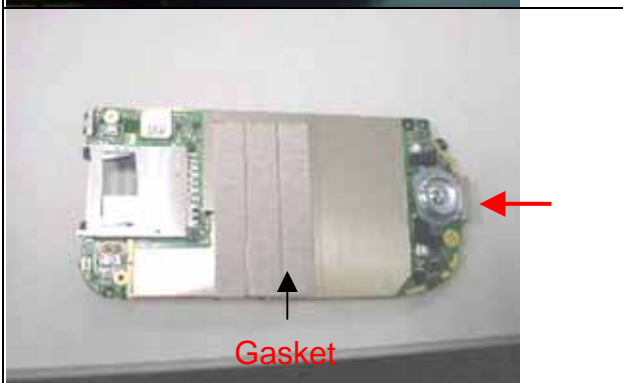
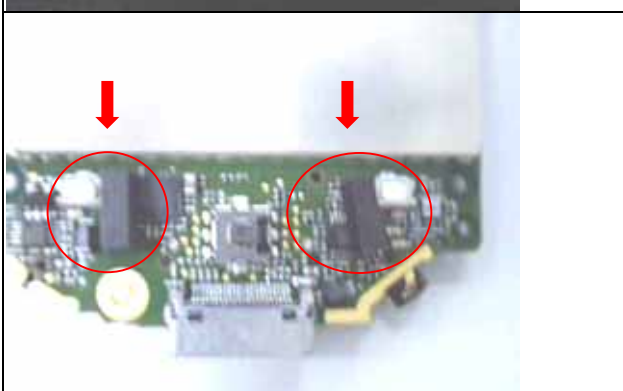
	<p><b>MB Pre-assembly:</b> There are 4 items need to be applied to MB , which are:</p> <p><b>1. Insulation tape</b> on lower right corner of MB , as shown on picture. Insulation tape P/N: <b>76H00469-00</b></p>
	<p>P/N for this insulation tape : 76H00469-00</p>
	<p><b>2. Gasket on shielding cover.</b> Need to apply 3 gasket on shielding cover. P/N: <b>72H00411-00</b></p> <p>Remember to insert <b>navigation button</b> to its place.</p>
	<p><b>3. Black poron of Send/End button</b> Next to paste 2 EA Poron (black) aside to <b>SEND</b> and <b>END</b> switch on MB. P/N: <b>76H00473-00</b></p> <p><b>Caution:</b> This is to focus the brightness of <b>LED</b> on <b>Send</b> and <b>Receive</b> button</p>

	<p><b>4.Black poron for volume button.</b> Next to apply one black poron on the volume button. The PN of this poron is <b>76H00483-00</b>.</p> <p>Note : Please make sure you have applied all of them on the MB.</p>
	<p>Install the MIC into its place.</p>
	<p>Before Assemble LCM , be noticed to apply stylus poron on the rear side of LCM Be noticed that the poron should not exceed the edge and interfere to bezel hooks.</p> <p><b>Note:</b> Be carefull especially during LCM replacement.</p>
	<p>Insert the LCM starting from lower bottom part and insert into the rib. Make sure Poron should not exceed the edge to prevent interfere to the bezel's hook and cause gap &amp; stylus stuck after assembly.</p>



Next Push aside the bezel and insert the LCM to click into 2 hooks located on right and left respectively.

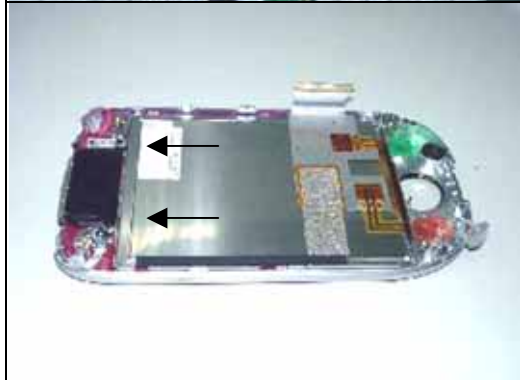

Assembly the speaker and fix two screws on it.

Screw P/N: **72H00401-00**

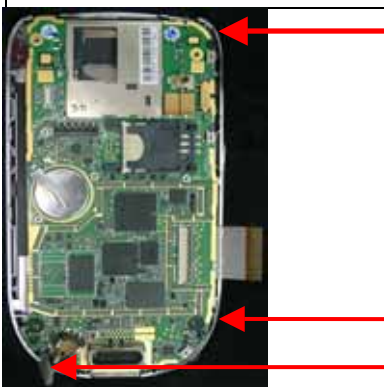

Apply 3 screws on MB

Screw P/N:72H00401-00

Torque : 0.8 kg-cm



Then insert the LCM FPC into the connector , make sure the FPC is fully inserted , then lock it by pressing the cover down.



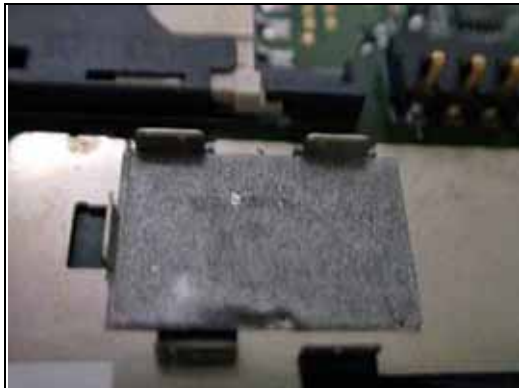

- Next Camera module assembly.
1. Make sure the Aluminium foil is clean and workable.
  2. Put the Camera on it.

Notice: In case of



Place the Camera into correct position and fix it.

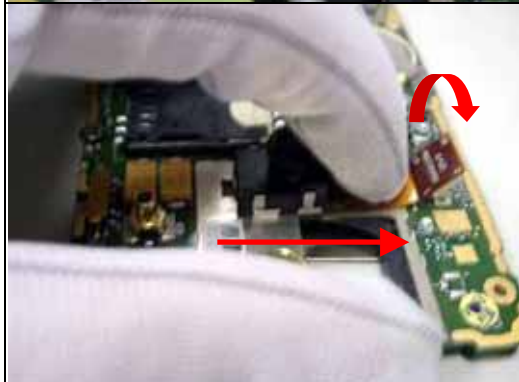

Important Notice:  
Before inserting the FPC into its connector, use your finger to flat the FPC first (as shown on picture) the lock it. (The FPC is fragile , to prevent break )



Make sure Camera is fixed correctly.



Next Close the Rear Housing to upper part starting from left side (with Volume button)



**TIPS:**  
Adjust the volume button to its center first before full closing the Housing .



**Antenna Assembly**  
Put the antenna into its place, starting from upper part, then press and insert its two ribs correctly to the housing.



Then fasten two screws of the antenna. Continuing with 2 screws at the lower bottom of housing.





**P/N: 72H00339-00**

Torque : 1.2 kg-cm

Next four screws at the middle part of housing ,

**P/N:72H00338-00**

Torque : 0.8 kg-cm



	<p><b>FIX Antenna Cover</b> Put the antenna cover and fix it starting from unit left side (side with volume button)</p>
	<p><b>Warranty Seal (Security Label)</b> Be sure to apply new Warranty seal once the unit has been repaired before sending back to customer. P/N: <b>77H00083-00</b></p>
	<p>In case of MB replacement, since the IMEI has to follow new MB IMEI, repair site is required to re-print Regulatory label to change IMEI no, but Serial No. should remain unchanged.</p>
	<p>Put the Battery into its place and lock it.</p>

	<p>Put back the battery cover.</p>
	<p>Put back the stylus, SD filler and Car antenna connector cover back into the unit.</p>
	<p>Now The unit is ready for performing TEST.</p>

The Unit Assembly is done ready for further tests.



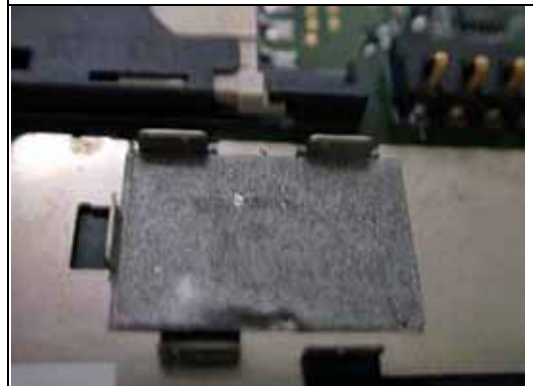

### 6.3 Camera Replacement assembly

In case of Camera defective, before replacing with new camera from Stock, please be noticed to add necessary pre-assembly part into MB and camera in advance.

	<p>Apply Aluminium foil on the MB as shown on figure. The upper layer paper of foil need to be removed before fixing camera on it.</p>
	<p>Next, apply insulation tape on it</p>
	<p>Then, paste the conductive tape on it .</p>
	<p>The upper layer paper of foil need to be removed before fixing camera on it.  Please follow above procedure of Camera fix on MB.</p>

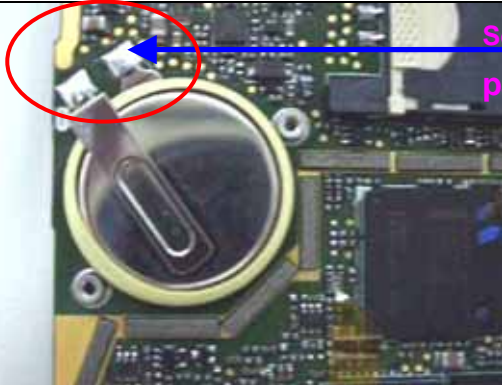
## 6.4 Connector, Back up battery replacement.

If you are authorized by HTC for component replacement, you could do below replacement with following notice:

	<p>Back up battery replacement.</p> <p>In case of back up battery defective, and need to be replaced, please be noticed to soldering requirement:</p> <ol style="list-style-type: none"> <li>1. Soldering Spec must be within <b>350 °C</b> / 5 seconds.</li> <li>2. Never touch the two pin in short circuit ,release one by one.</li> </ol>
	<p><b>Warranty Seal (Security Label)</b></p> <p>Be sure to apply new Warranty seal once the unit has been repaired before sending back to customer.</p> <p>P/N: <b>77H00083-00</b></p>
	<p>In case of MB replacement, since the IMEI has to follow new MB IMEI, repair site is required to re-print Regulatory label to change IMEI no, but Serial No. should remain unchanged.</p>
	<p>Put the Battery into its place and lock it.</p>

## 7. Problem Diagnostics

### 7.1 List of Test Jigs

Item Name	Usage	Remark
RS-232 Serial Cable/Cradle	For data port test	Use specified for PDA Phone II
USB Cable/Cradle	For data port test	Use specified for PDA Phone II
Special Plastic Tool	For unit disassembly	Share with PDA phone I
AC Adapter	For battery recharge and power related tests	Use specified for PDA Phone II
Earphone with Microphone	For audio test	Use specified for PDA Phone II
SD Card or MMC Card	For write protect, read and write test	Share with PDA phone I
SD card with <b>diagnostic</b>	For Function test diagnostic	Use specified for PDA Phone II
Personal Computer (PC)	Use for Communication/Synchronization test	Refer requirement below

### 7.2 <Hardware Requirement for PC>

- O.S.: Windows 98/ME/2000
- CPU: Pentium 166MHz or above
- Memory: 64MB~128MB

### 7.3 < Software Requirement>

- Microsoft Active Sync **version 3.7**
- Diagnostic Program loaded on SD card.

## 8. Diagnostic Program

### 8.1. List of Test Items

No.	Item	Description	Remark
1	RAM Test	RAM Check Size/Write/Read/Comparison test.	
2	Display Test	Test the LCD display quality.	
3	Touch Test	Touch screen alignment test. Suggest to test in WinCE	
4	Playback Test	Play sound with 8KHz simulation wave.	
5	Record Test	Record audio sound and playback it(INT/EXT)	
6	Button Test	Test every most of button.	
7	Checksum Test	To show checksum value after Code reflash	
8	B Light Test	Back light ON with in different brightness level.	
9	LED Test	Test the message LED.	
10	Battery Test	Check the status of battery and AC power.	
11	Vibrater Test	Test the function of the vibrater.	
12	SD Test	SD card Write/Read/Write Protect test.	
13	Clean Talk Time	Clean Talk time(Air time) & Format PIM storage <b>CAUTION:</b> This item is applied for refurbishment case only. For same unit repair back to customer is not necessary.	
14	USB Test	Suggest to test in Windows CE	
15	Sir Test	Suggest to test in Windows CE	
16	Serial Test	Suggest to test in Windows CE	

### 8.2 Test Items Operation

#### How to Enter Test Mode

>Insert SD card (with Diagnostic program pre loaded ,sent by HTC) into SD slot of unit.

>Power on the unit. While **press** and **hold** the **Power Button, Action button** and **Reset** the unit with the Stylus, release RESET button first about 1 second to enter the Test Mode. You will find the display as following:



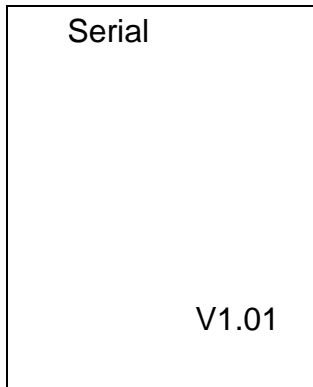

Then, wait about 10 seconds, the display will show :

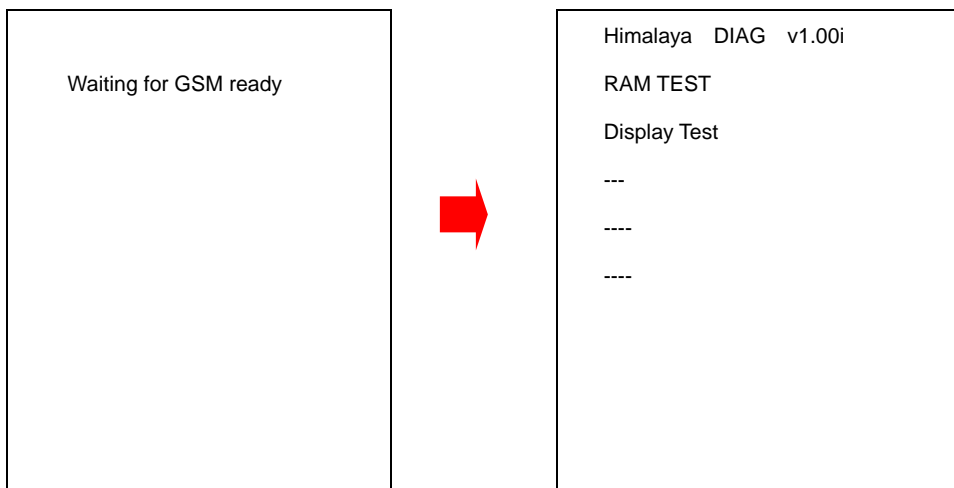

**How to select test item:**

Using navigation button -"Up" or "Down" to select the test items

How to execute the test program: Press "**Action**" to start the test

No.	Item	Description	Possible cause if fail
1	RAM Test	Display Size and read/write test. It will show <b>OK if pass.</b> <b>Stop on fail.</b>	Could be M/B issue
2	Disp Test	Unit prompts for different display page to detect the defect of LCD, lines or dots. <b>First display is WHITE screen,</b> <b>Press left to DARK screen</b> <b>Press UP to Multiple Color</b> <b>Press RIGHT for back to MENU</b>	Could be LCD issue

3	Touch Test	Tap the cross mark (+) with stylus on the correct location. Fail if no reaction Calibrate the screen following the + mark. Press ACTION to exit.	Could be LCM issue
4	Play Test	Play the tone with 8KHz/L-channel, then Hear the sound and notice if bad sound quality happens	Could be speaker or M/B issue
5	Record Test	Select this item to record test, then press Action to start recording. It will automatically playback it. Then connect with earphone or external speaker and press action to check the record function is OK or not thru ext speaker.	Could be MIC or M/B issue
6	Button Test	Press each button to know if it works. Follow the instruction shown on the screen to finish the test item Stop on fail.	Could be switch or MB issue
7	Checksum	Verifies the checksum of the code.	
8	B Light Test	Back Light turns ON and Off, Check the light change Starting from Level 3 Press Action button to enter Level 2 Press Action button again to enter Level 1 Press Action again to enter Level 0 Action again for back to MENU	Could be M/B or LCM issue
9	LED Test	The message LED will show starting with RED Press Action LED will change to GREEN Press Action LED will change to AMBER Press Action Key LED will ON (YES & END) Press again Action will back to MENU	Could be LED or M/B issue
10	Battery Test	Test main battery and AC power source. Insert AC power CUR will show "+ " means charging , remove AC power CUR will show "-" means internal power. <b>Note: The Battery capacity shown is only for reference</b>	Could be main battery or M/B
11	Vibrator Test	Press action, units should vibrate. Press Action again back to MENU	Check the vibrator

12	SD Test	Insert SD card (Enable Write Protect) and start test. Pull out the SD card if you see the message< "Pluck OK ><Locked > Please remove locked SD . Adjust lock switch to unlock site (Disable Write Protect), and insert it. The program will read & write to SD card for test. Once finished, display will show Please remove SD card. Press Action back to MENU	Could be M/B issue
13	Clean Talk Time	Select this item to clean AIR TIME (Talk time) and Customer PIM data.	<b>Use this item only for REFURBISHMENT CASE</b>
14	USB Test	Plug USB cable to connect PDA to PC then and check for the connection in WinCE.	Could be M/B issue
15	SIR Test	Prepare another unit as 'supporting' site. On test unit, please choose 'Test Target' and press action button to start test. Before test, make the IR ports of them face to each other.	Could be M/B issue Suggest to test it in Windows CE mode.
16	Serial Port Test	Check this item in Windows CE mode.	Could be M/B issue

## 9. Main Battery Test / Judgement procedure

### A. Main Battery only

#### 9.1 Requirement:

- PC with Windows 2000
- Taylor Made Battery test fixture
- Battery Test program (DS2760K) , install CD package to your PC.

This program is used only if the battery failed on charging via Main unit, ie. Power Bar does not response to charge via AC adapter, Battery suspected to defective.

#### 9.2 Program Installation

-Click SET UP to Install, once entering the program,

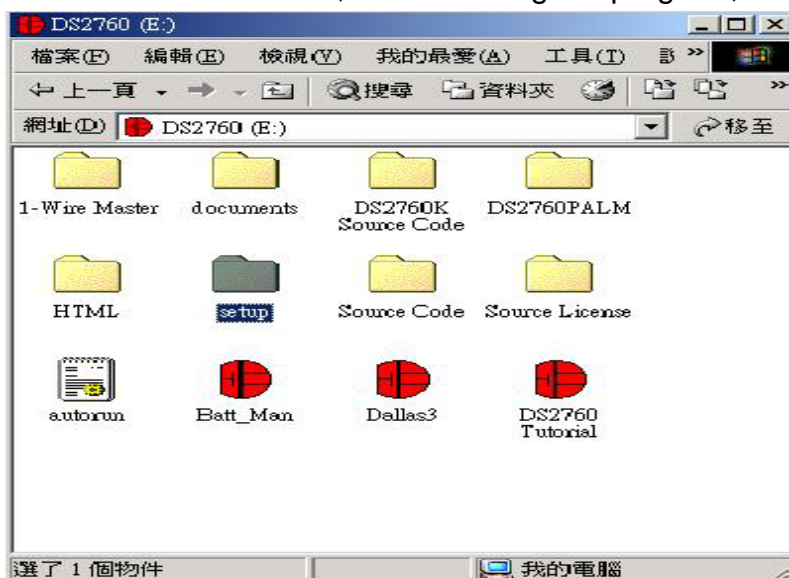

- 1.Connect the battery test fixture , one side to PC Com port, the other side (with two pin head) to the main battery pin 2 and 3 (counted from left ) as shown on figure.

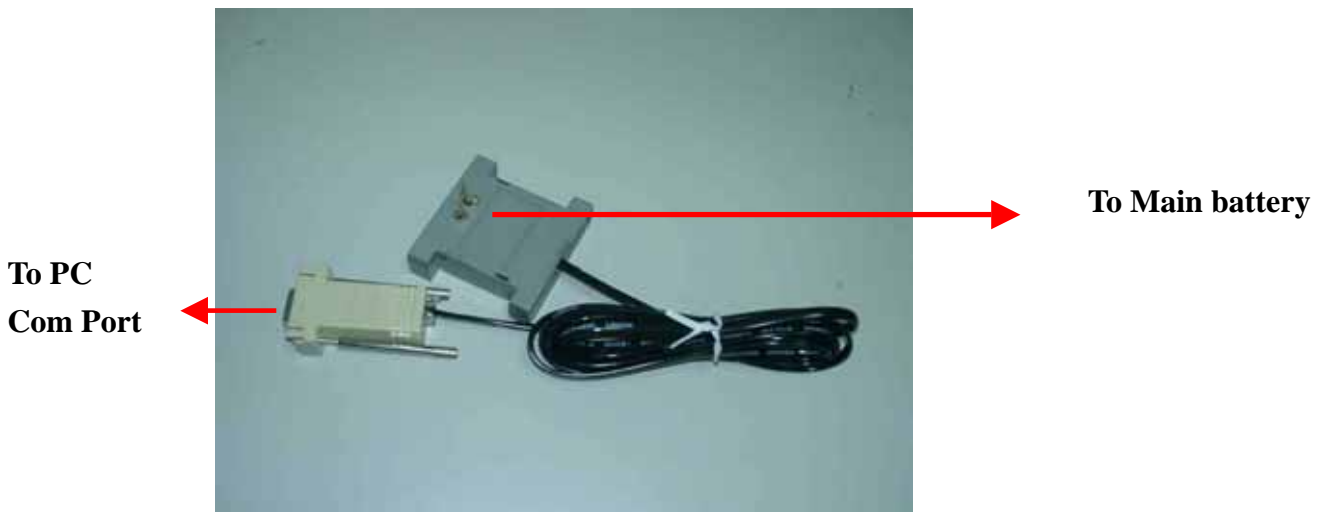

-2. Set and press the thimble to touch the main battery pad Pin 2 & 3 (counted from left to right), be noticed not to touch (short circuited) each other.

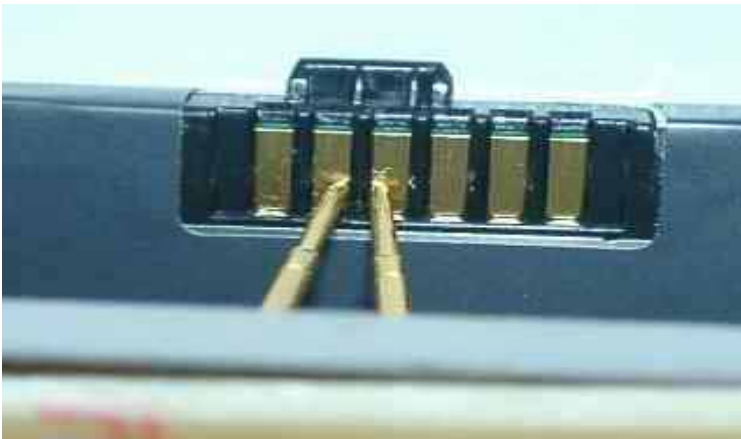

-3. Check **Voltage** on DS2760K program

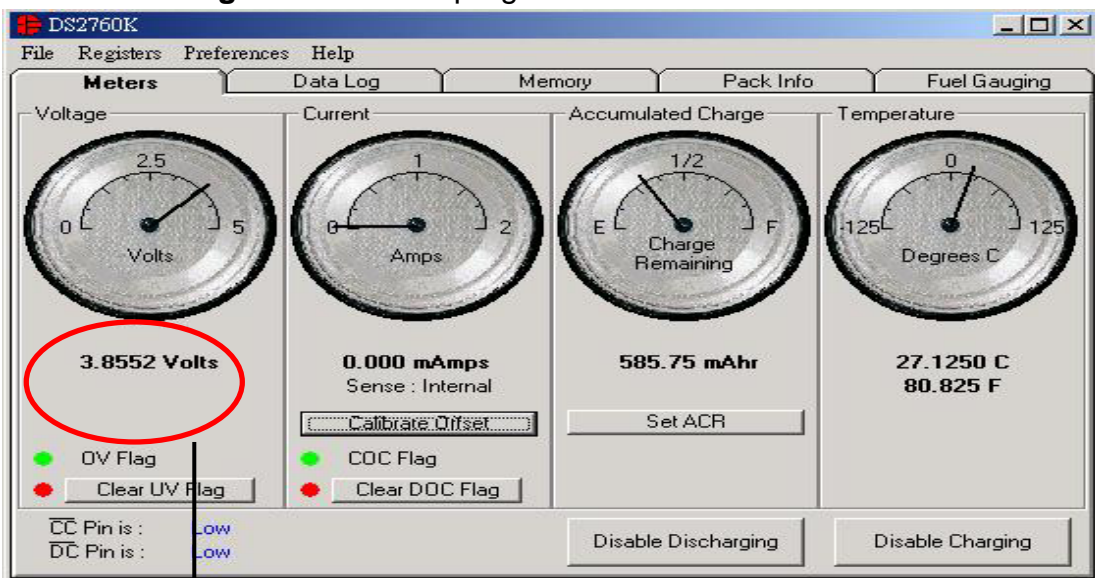

**Voltage > 2.5 V**  
Voltage should Exceed 2.5 V

-4. Current measurement .

Measured value should be within the range:-3.125 ~ +3.125 V.

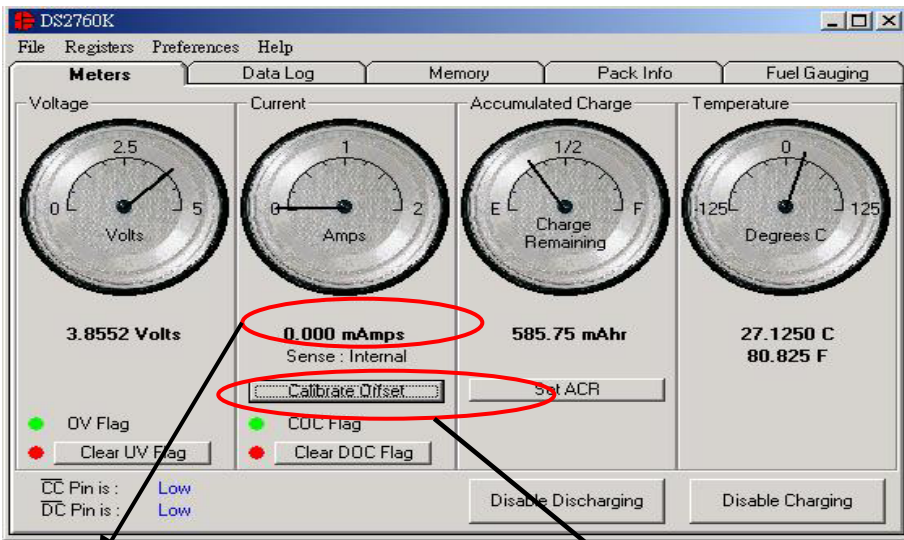

**1.Current mesurement**  
It should have the value within  
+ 3.125~ -3.125 mAh

**2. If value incorrect, need to Click "Calibrate Offset" button first for double confirmation.**  
**The value will be calibrated automatically. (it may takes about 15~ 20 seconds)**

5- CC and DC status Check

Both Pin should be in **LOW** , otherwise it is judged as defective.

Following table is the criteria for Voltage and current status:

ITEM	Description	Measurement status
1	Battery <b>VOLTAGE</b>	Voltage should be <b>2.5 V</b> Above. If the voltage is under 2.5, it means that the battery is over discharged and defective.
2*	Battery <b>Current</b>	Current should be between <b>-3.125 ~ + 3.125 mA</b>

3	<b>CC &amp; DC Pins status</b>	Both should be on <b>LOW</b> . If on HIGH, means the battery is defective.
---	--------------------------------	--

Note: \* If the current value is incorrect, Please click “Calibrate offset” to calibrate the value (it takes about 15 seconds) and check again.

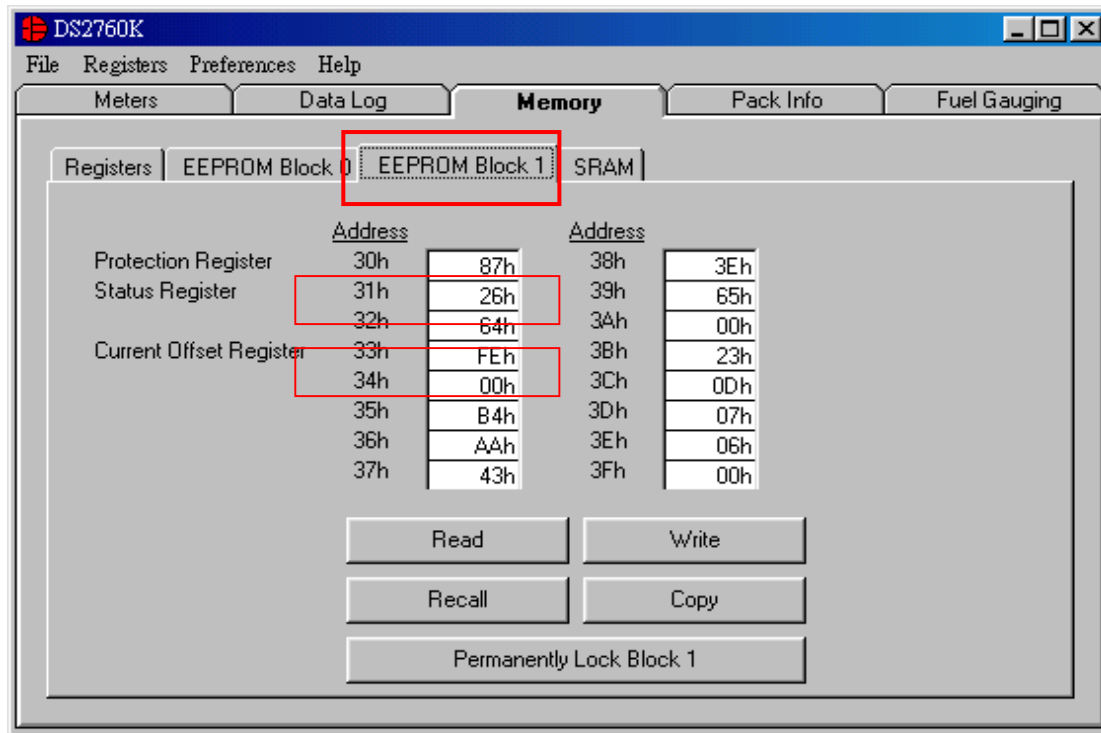

**Criteria for EEPROM (Block 1) Status:**

ITEM	Description	Measurement status
1	Address <b>31h</b>	Register address Should be <b>26h</b>
2	Address <b>34h</b>	Register address Should be <b>00h</b>

**If the register address is incorrect, it means that the EEPROM is defective.**

**B. Battery Performance on unit with Run Down Program**

**B1. Requirement:**

- PC with Windows 2000.
- USB cable
- ActiveSync 3.7
- Run Down Test Program from HTC
- Criteria

**B2. Procedure:**

- Establish The connection between your PC and PDA phone.
- Copy Run Down software to your PDA phone (My Document)
- It is required to **turn off Bluetooth** setting manually before executing the Run down.
- Execute Run Down and choose 1 hr , the program will stop automatically after one hour.
- After one hour, find the Power cap.txt file on **FILE Explorer >My device> Power cap** to check battery capacity after running one hour.

Notes: The result on Power cap will be re-write to new one once you execute the Run down again.

**-Criteria :** The battery capacity should be above 50 % after running Run down.

<b>Criteria on running Run Down Test Program</b>	
Battery capacity after Run down <b>one</b> hour	<b>Capacity    50 %</b>



### 9.3 Current consumption measurement



**1. Equipment requirement**

- A. Power Supply (set at 4 V /1A).
- B. Micro-Current Meter (support 0.5mA ~ 1A st least).

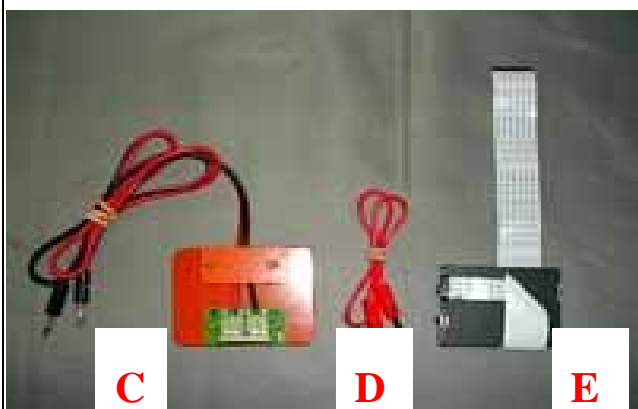

**2. Fixture requirement**

- C. Current series jig.( with black and red cable)
- D. Cable
- E. Battery with extension cable



- 3. Connect cable (D) to positive polarity of power supply (A) and current meter (B)

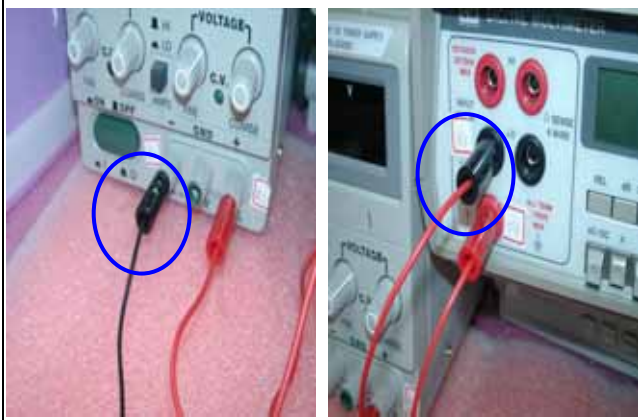

- 4. Connect cable of fixture( C ) to negative polarity of power supply (A) and current meter (B)

Note : black cable to power supply (A) and red cable to current meter (B)



**5. Ready for testing**  
(Don't turn on power at this moment)



**6. Install battery fixture (E) to unit**  
**7. Turn on power supply ( 4V)**  
**8. Turn on current meter ( 2A)**



**9. Press Power button to turn on the unit**  
**10. In "main page", Check phone status, Click "Turn on flight mode"**

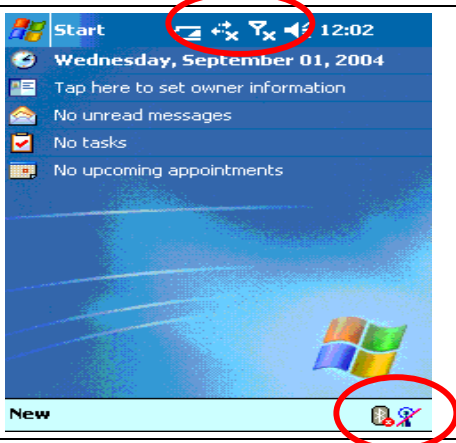

**11. Make sure all the RF function is closed already**



12. Press and hold power button until turn off back light, the current will be showing on current meter, this status is so called "idle mode" ,

**The criteria is as follows**

**$\leq 86.5 \text{ mA}$**

Unit is turn on and no back light







13. After idle current checked, press power button then release soon, the screen will be off, this status is so called "sleep mode"

**The criteria is as follows**

**$\leq 3.75 \text{ mA}$**

Unit is turn off and no display

**10.LCM Inspection Criteria (New part only)**

Inspection Defects		Acceptance Level
Bright dots	Single dots 	<p><b>Red+Green+Blue <math>\leq 5</math></b></p> <p><b>Total number of Red, Green and Blue dots should be less or equal to 5.</b></p> <p><b>Green <math>\leq 2</math></b></p> <p><b><u>Total number of Green dots</u> should be less or equal to 2.</b></p> <p><b>S <math>\geq 5</math> mm</b></p> <p><b><u>Distance</u> between any two bright dots should be greater than or equal to 5mm.</b></p>
	2 adjacent dots 	<p><b>N <math>\leq 2</math></b></p> <p><b>Total number of 2 adjacent bright dots should be less or equal to 2.</b></p>
	3 or more adjacent dots. 	<p><b>N = 0</b></p> <p><b>None of 3 or more adjacent dots is allowed.</b></p>
Dark dots	Single 	<p><b>N <math>\leq 5</math></b></p> <p><b><u>Total number of Dark dots</u> should be less or equal to 5.</b></p> <p><b>S <math>\geq 5</math> mm</b></p> <p><b><u>Distance</u> between any two dark dots should be greater than or equal to 5mm.</b></p>
	2 adjacent dot 	<p><b>N <math>\leq 2</math></b></p> <p><b>Total number of 2 adjacent dark dots should be less or equal to 2.</b></p>
Dark or Bright lines		<b>0</b>

	<b>All allowable defect dots</b>	<b>Total Number <math>\leq 8</math></b> <b><math>S \geq 5</math> mm</b>
<b>Foreign scratch, Object or lints (Power Off status)</b>	<b>Scratch</b>	<b><math>0.03 &lt; W \leq 0.1</math> (mm)</b> <b><math>0.3 &lt; L \leq 3</math> (mm)</b> <b><math>N \leq 6</math></b>
	<b>Lint ( linear foreign objects)</b>	<b><math>0.03 &lt; W \leq 0.1</math>(mm)</b> <b><math>0.3 &lt; L \leq 3</math> (mm)</b> <b><math>N \leq 5</math></b>
	<b>Spots</b>	<b><math>0.1 &lt; D \leq 0.25</math> (mm)</b> <b><math>N \leq 5</math></b>
	<b>Fish eye on film</b>	<b><math>0.15 &lt; D \leq 0.4</math> (mm)</b> <b><math>N \leq 3</math></b>
	<b>Breakage on film surface</b>	<b>Not acceptable</b>
	<b>Total acceptable defect quantity <math>\leq 10</math></b>	
<p><b>NOTES:</b>  <b>S</b> = Distance between each dot; <b>W</b>=Width ; <b>L</b>=Length ; <b>N</b>= Number(quantity);   <b>D</b>=Diameter</p>		

Inspection done at least 30cm away from inspector's eyes at a  $\pm 45$  degrees of viewing angle for a duration of 5 seconds with an Ambient illumination of 500-1000 Lux (Incandescent lamp)

1. Bright dot: A pixel that is always lit no matter display changes. It could be red, green or blue normally.
2. Dark dot: A pixel that is always off (no emitting light) no matter display changes.

## 11.RF

### 11.1RF TEST REQUIREMENT.

For RF antenna test, you need to set up your mobile tester , Antenna coupler and Shielding box to meet HTC specification and requirement.

### 11.2 Hardware Requirement:

1. Mobile Tester.
2. Plane Antenna
3. Test Jig.
4. Shielding Box
5. RF golden sample
6. RF cable

### 11.3 RF test Picture (refer attached picture)

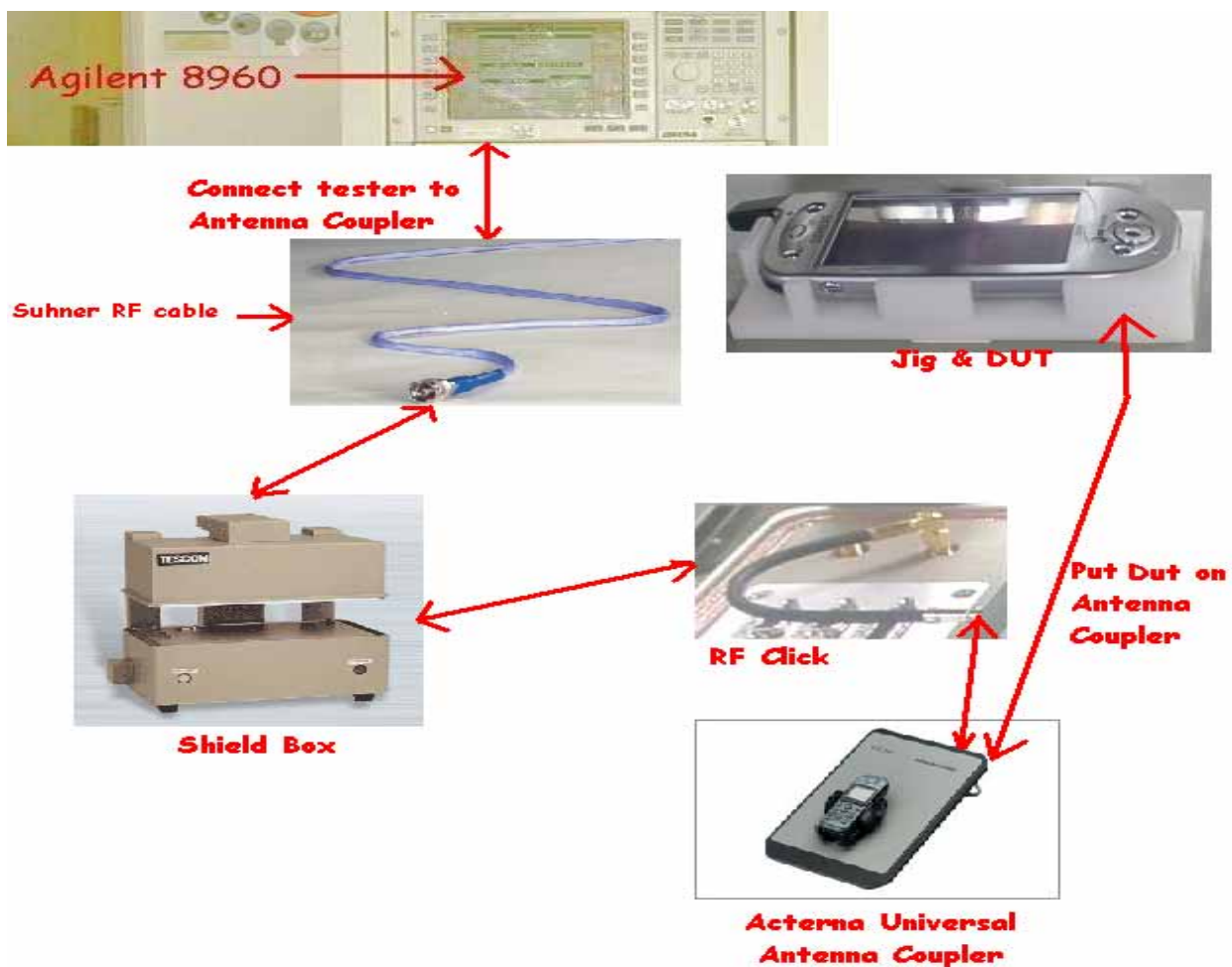

### 11.3 RF Antenna Spec.

	<b>PDA Phone2</b>	<b>RF Antenna Test Spec</b>	Revision 1.0 11/04/2003
---	-------------------	-----------------------------	----------------------------

Item	Test Name	Tx level	TCH	1 <sup>st</sup> Download cell power	Note
1	Camp @DCS Band	0	512	-75	BCH=600
2	BS Originate call	0	512	-75	
<b>GSM 900 RECEIVER TEST</b>					
3	Fast Bit Error Rate	5	975	-104	
4	Fast Bit Error Rate	5	40	-104	
5	Fast Bit Error Rate	5	124	-104	
<b>GSM 900 Transmitter TEST</b>					
6	TX Phase RMS Error	5	975	-104	
7	TX Phase Peak Error	5	975	-104	
8	TX Frequency Error	5	975	-104	
9	TX Phase RMS Error	5	40	-104	
10	TX Phase Peak Error	5	40	-104	
11	TX Frequency Error	5	40	-104	
12	TX Phase RMS Error	5	124	-104	
13	TX Phase Peak Error	5	124	-104	
14	TX Frequency Error	5	124	-104	
15	Check TX Power	5	975	-104	
16	Check TX Power	5	40	-104	
17	Check TX Power	5	124	-104	

### DCS 1800 Receiver Test

1	Fast Bit Error Rate	0	512	-104	
2	Fast Bit Error Rate	0	698	-104	
3	Fast Bit Error Rate	0	885	-104	

### DCS 1800 Transmitter Test

4	TX Phase RMS Error	0	512	-104	
5	TX Phase Peak Error	0	512	-104	
6	TX Frequency Error	0	512	-104	
7	TX Phase RMS Error	0	698	-104	
8	TX Phase Peak Error	0	698	-104	
9	TX Frequency Error	0	698	-104	
10	TX Phase RMS Error	0	885	-104	
11	TX Phase Peak Error	0	885	-104	
12	TX Frequency Error	0	885	-104	
13	Check TX Power	0	512	-104	
14	Check TX Power	0	698	-104	
15	Check TX Power	0	885	-104	

### PCS 1900 Receiver Test

1	Fast Bit Error Rate	0	512	-104	
2	Fast Bit Error Rate	0	662	-104	
3	Fast Bit Error Rate	0	810	-104	

### PCS 1900 Transmitter Test

4	TX Phase RMS Error	0	512	-104	
5	TX Phase Peak Error	0	512	-104	
6	TX Frequency Error	0	512	-104	
7	TX Phase RMS Error	0	662	-104	
8	TX Phase Peak Error	0	662	-104	
9	TX Frequency Error	0	662	-104	



10	TX Phase RMS Error	0	810	-104	
11	TX Phase Peak Error	0	810	-104	
12	TX Frequency Error	0	810	-104	
13	Check TX Power	0	512	-104	
14	Check TX Power	0	662	-104	
15	Check TX Power	0	810	-104	

## 12.OS Upgrade and GSM code Upgrade.

### 12.1 RUU (Rom Upgrade Utility)

OS upgrade is performed via RUU download from customer web.

### 12.2 RSU (Radio Stack Upgrade)

GSM Upgrade is performed via RSU download from customer web.

For OS Upgrade and GSM upgrade , it is different if compare to PDA phone 1 model .

The Upgrade method is different compare to previous model due to security issue . Service center is required to make the first master unit via RUU (Rom Upgrade Utility) and RSU (Radio Stack Upgrade) method .RUU & RSU upgrade package could be download from HTC FTP or customer web with some easy step . Make sure your master unit is fully charged before starting to download.

Based on this mechanism, service center is recommended to prepare some 64 MB SD card in advance for SD download purpose.

Attached step will lead you how to build your master unit via :

1. RUU mechanism.
2. New sample unit

Also the procedure to create your own SD card for reflash purpose,then for each repair unit, you only need to do reflash via SD card. You could decide how many SD card you need for this purpose depend on your need.

## 1. Execute RUU

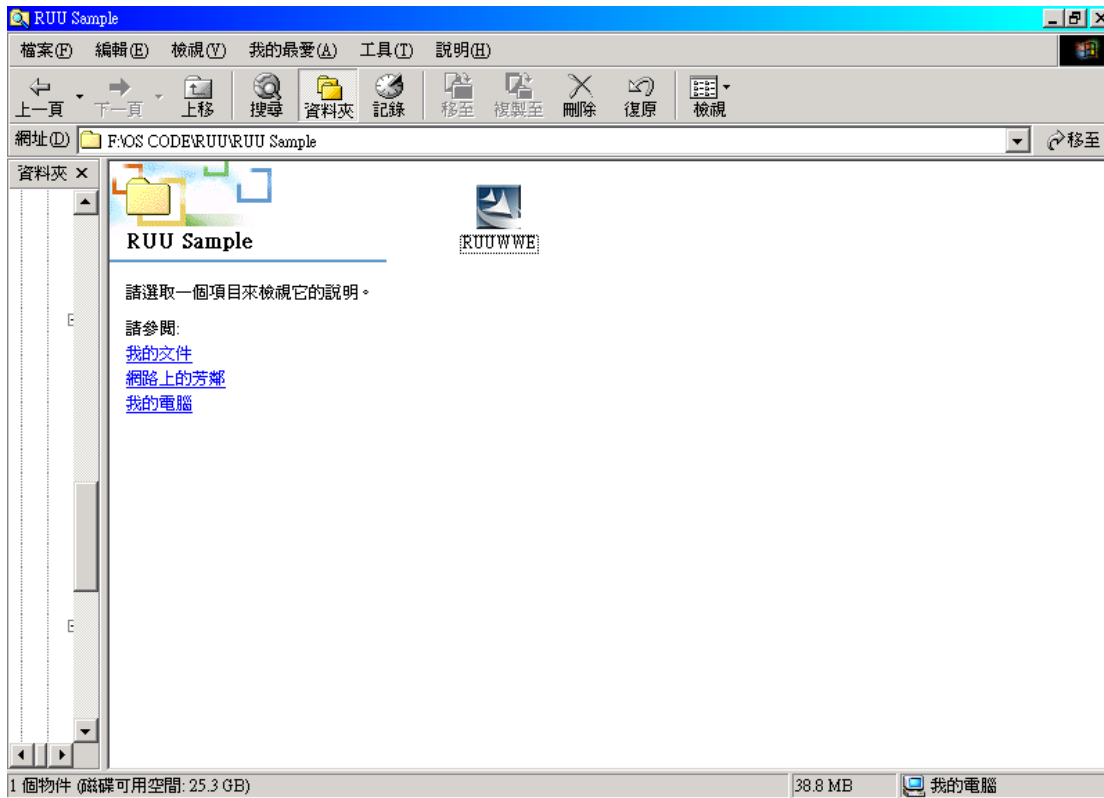

2. Following display will show on screen:

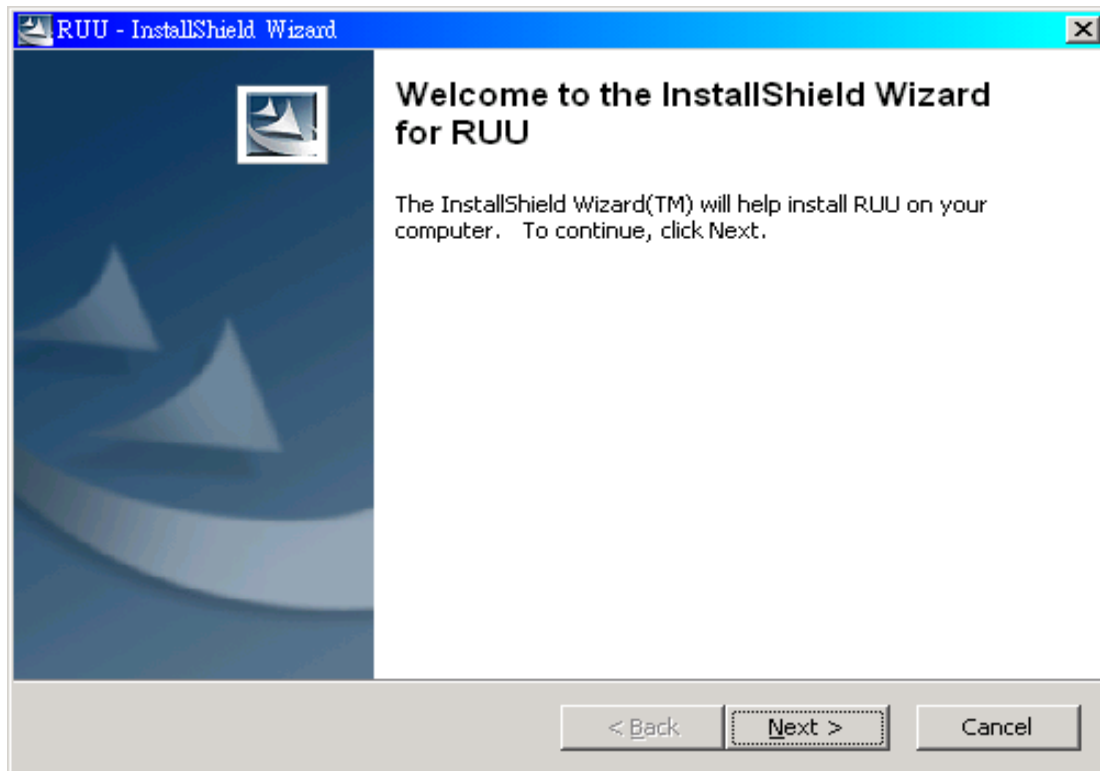

### 3.Type Next

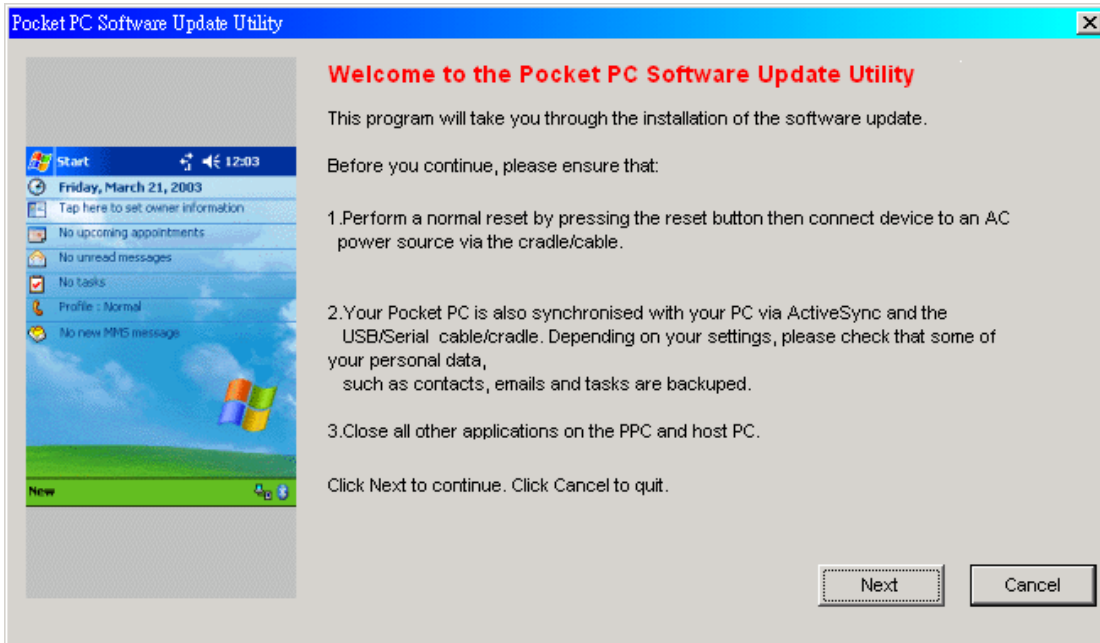

4.Follow the instruction on PC and make sure Active Sync connection is established before go to **NEXT**

5.Following will show on display:

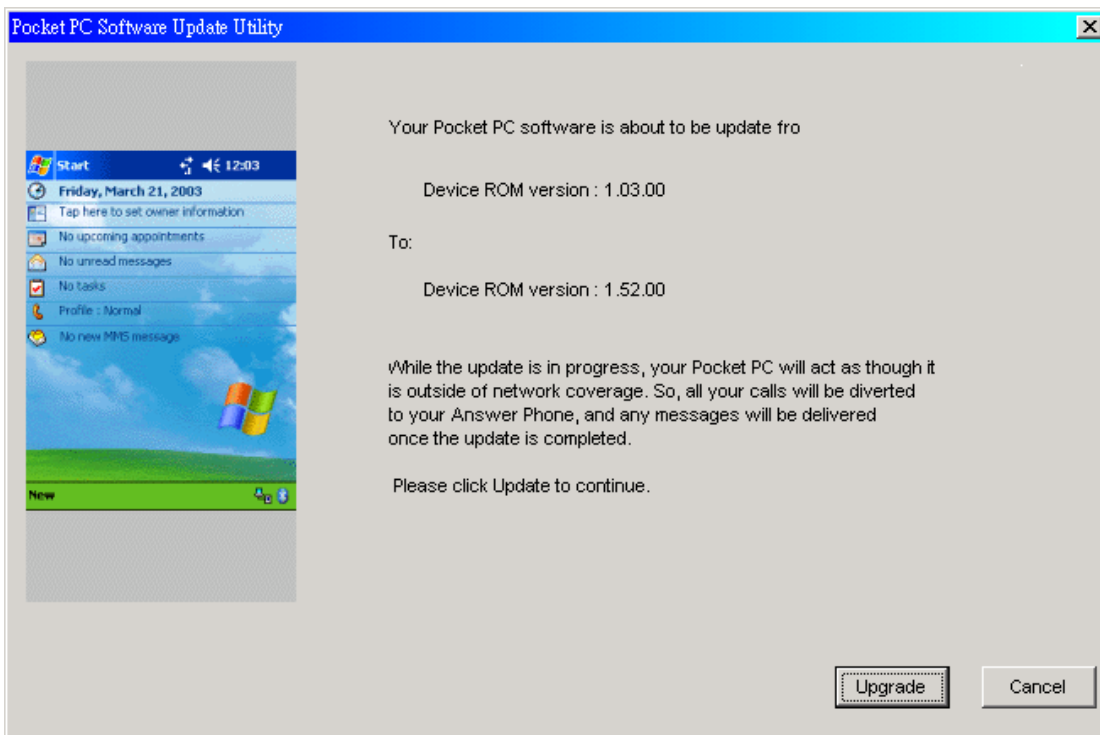

6.Select **UPGRADE** and wait until process completed.

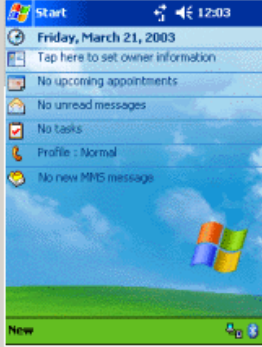

Start Friday, March 21, 2003 12:03

Tap here to set owner information

No upcoming appointments

No unread messages

No tasks

Profile : Normal

No new MMS message

Stage1: Erasing ROM image. Please wait ...

26 %

The current software is now being erased from your Pocket PC. This will only take a few minutes.

Totally, the update should take about 30 minutes.

**Remember, please don't disconnect your Pocket PC from your PC or the power supply until the upgrade is complete.**

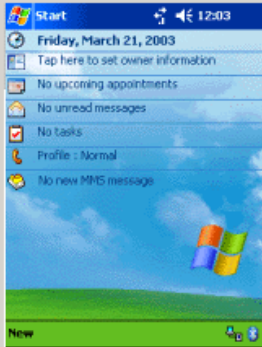

Start Friday, March 21, 2003 12:03

Tap here to set owner information

No upcoming appointments

No unread messages

No tasks

Profile : Normal

No new MMS message

Stage2: Upgrade ROM image. Please wait ...

11 %

The current ROM image is now being updated from your Pocket PC. For the USB connection, the process will take approximately 30 minutes.

**Remember, please don't disconnect your Pocket PC from your PC or the power supply until the upgrade is complete.**

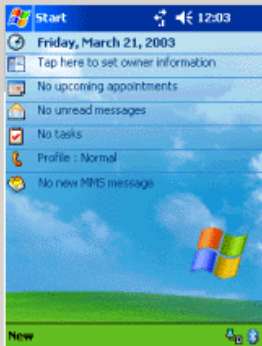

Start Friday, March 21, 2003 12:03

Tap here to set owner information

No upcoming appointments

No unread messages

No tasks

Profile : Normal

No new MMS message

Stage3: Upgrade Extended ROM. Please wait ...

6 %

The current ROM image is now being updated from your Pocket PC. For the USB connection, the process will take approximately 30 minutes.

**Remember, please don't disconnect your Pocket PC from your PC or the power supply until the upgrade is complete.**

7. Once completed, Display will show as below, follow the instruction on PC .

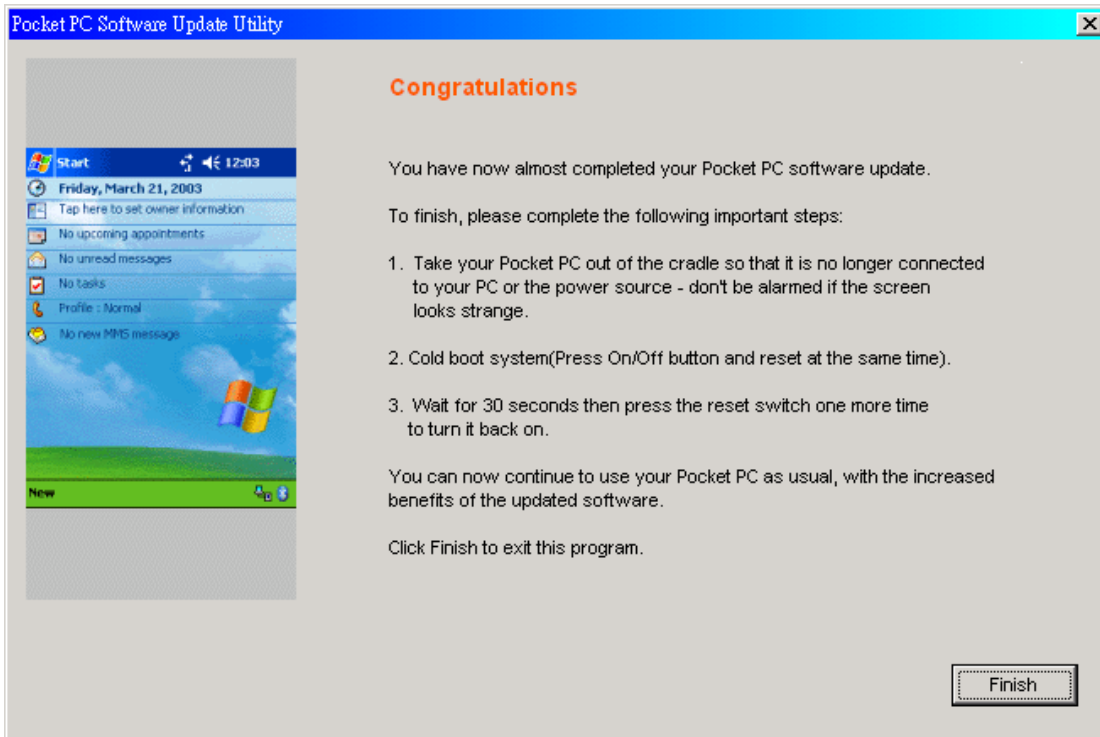

## 8.DONE.

### 12.3. Following is the complete procedure for SD reflash.

	<b>PDA Phone2</b>	<b>OS, Radio &amp; Ext. Rom Firmware Upgrade Procedure</b>	Revision 1.0 11/04/2003
--	-------------------	--	----------------------------

#### System Requirement:

- Windows 2000
- USB Cable or Cradle
- MTTY.exe
- Master Unit with most update Rom Code
- 64 MB SD/MMC card.

**Caution:** The unit must have at least 70% of battery capacity before starting the re-flash process. Charge the battery in advance if necessary.

**Note :** For the master unit, you could prepare it on these following ways:

- Take one from Swap unit with most update Rom Code.
- Build one first by connecting to HTC FTP or customer web for OS Upgrade/ Download via RUU/RSU.

#### *A. Upload most update code from master unit to SD /MMC card.*

**(You Only need to do this ONCE when New Update is received)**

**Requirement:** (1) Mtty.exe tool ver.1.10 or above (2) USB cable or USB cradle (3) Window2000 or above (4) Master unit with most update OS ROM Image

#### 1. Execute MTTY.exe and set into USB Port

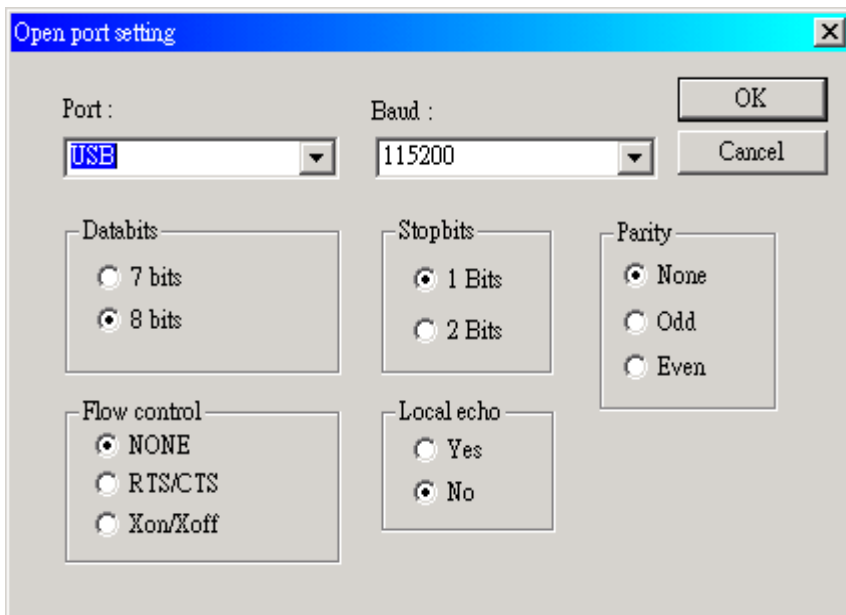

2. Uncheck USB and COM1 in Connection Settings in ActiveSync if you have installed the ActiveSync in your PC and make sure the USB port is available.

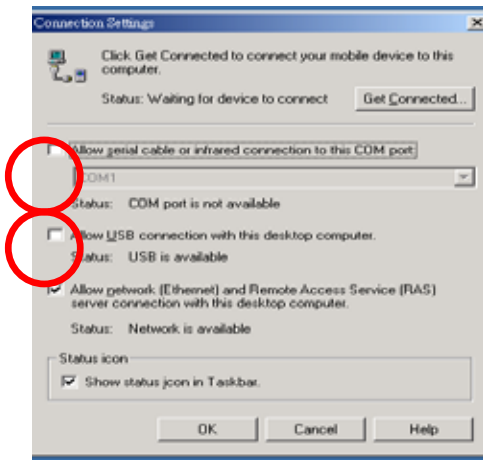

3. Set the Unit into Bootloader Mode (While Press & Hold Power, Action, and Reset the units), wait for Serial on display. Message on PDA Screen:

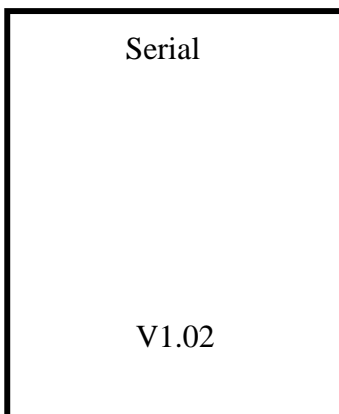

4. Connect the unit to the PC with **USB cable or USB cradle**, unit display will change to **USB**

5. Insert 64 MB SD or MMC card into SD slot of PDA Phone

6. On the PC side, Select OK and press ENTER.

7. Following display will appear:

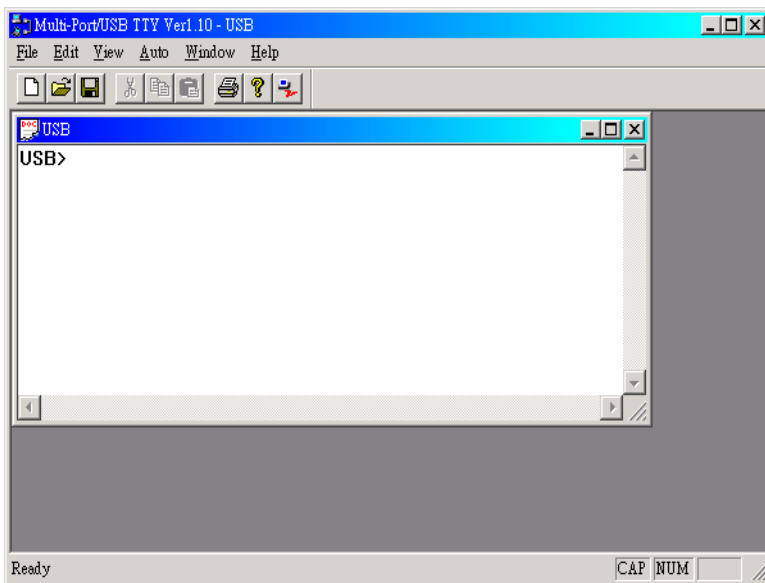

**8. The prompt “USB>” will appear , then to UPLOAD PDA Image , Type:**

**USB>d2s 80000000**

(means to upload PDA image code to SD card by typing d2s command, note there is a blank space between d2s and the address), then Press **ENTER**

**The following display will be shown on PC display .....**

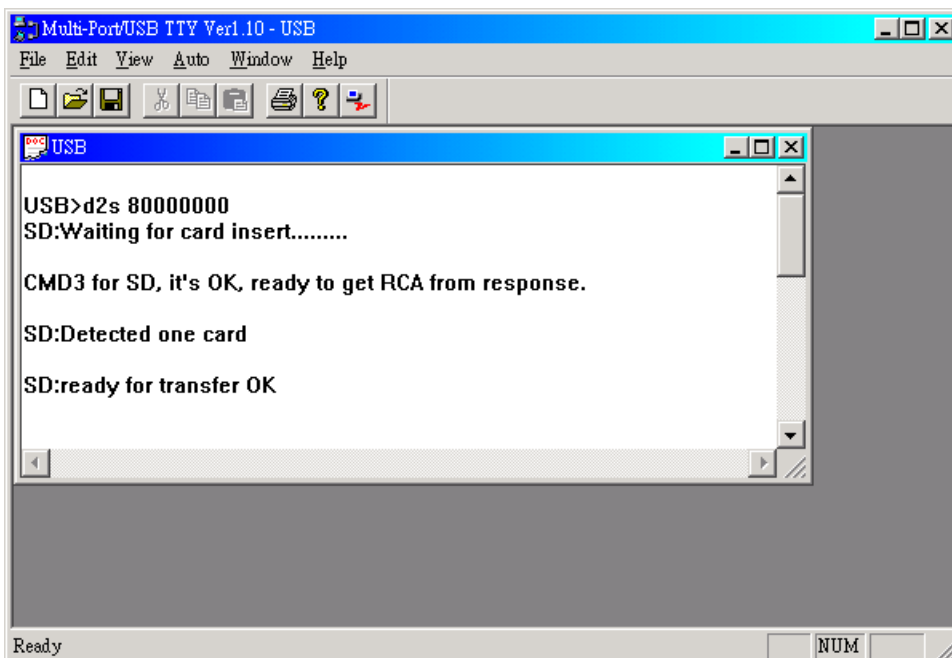

The process begins and wait for 5 to 6 minutes until it shows **Done**.



**CAUTION! DO NOT REMOVE THE USB CABLE FROM THE PC OR PDA, FAIL TO DO SO MAY CAUSE DEVICE UNIT FAIL TO BOOT.**

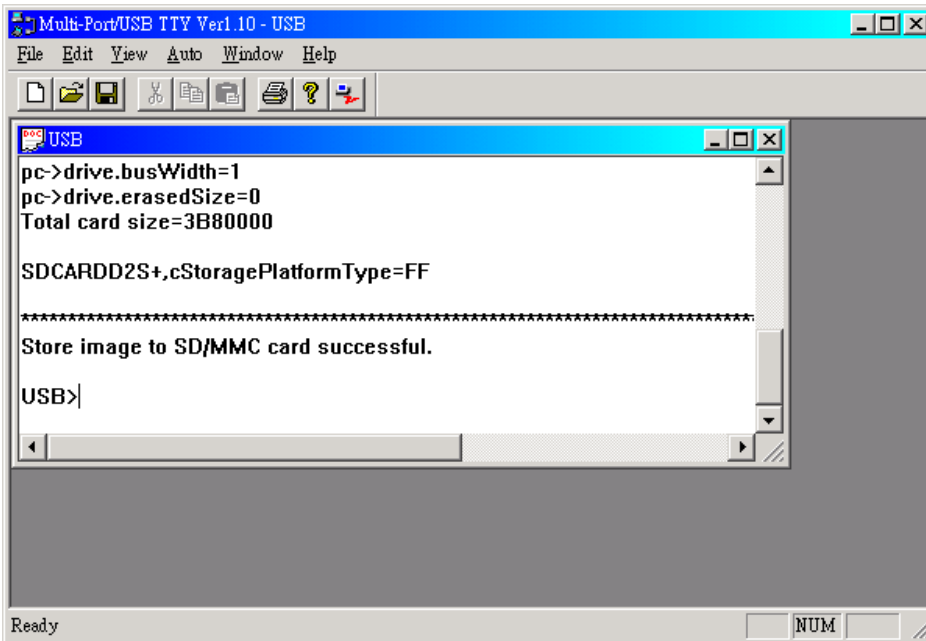

Once done, above display will be shown on PC display, while on PDA phone , a message of: 100% Checksum is OK .

**9. Next, continue to upload **Radio part** by typing:**

USB>d2s 60000000 300000 sd a

(Please notice the blank space between d2s and address, sd and a .)

Then press ENTER, following display will be shown:

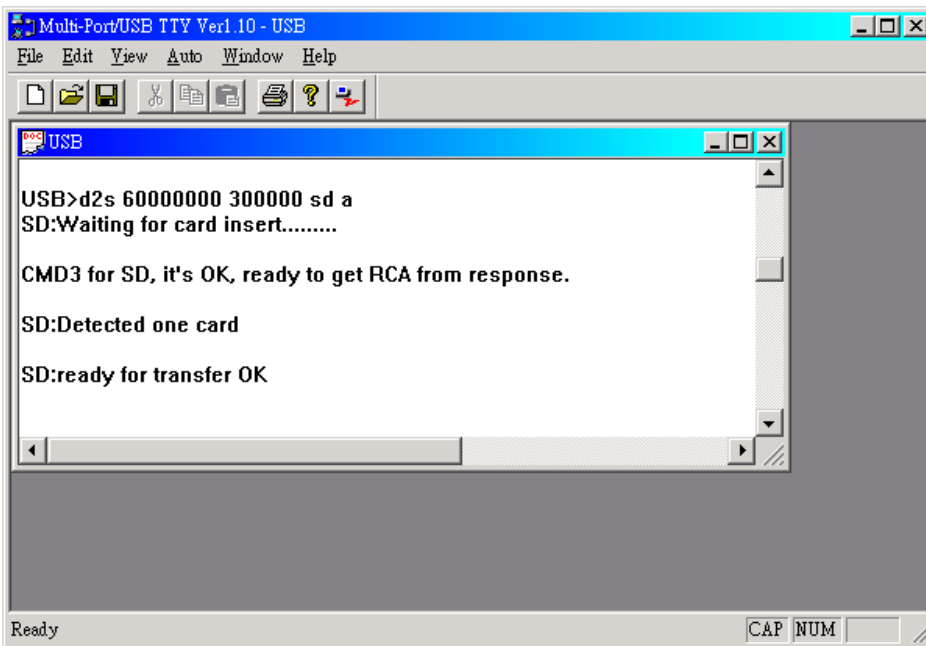

Again, on PDA phone will show message :  
100% Checksum is OK .

#### 10. Continue with M-SYSTEM part.

USB>d2s 70010000 1070000 sd a

Then press **ENTER**

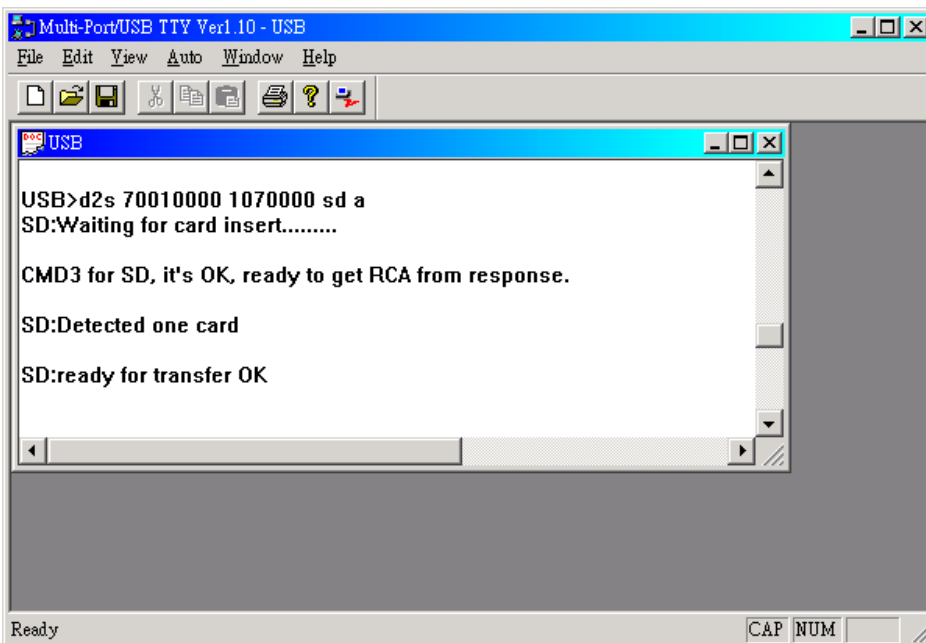

PDA Phone display will show:  
100% Checksum is OK .

HTC confidential

© 2001, HTC Corporation. All rights reserved.

TOTAL 77 CONT.ON. 59 PAGE NO. 58

When it is Done, PC display will show:

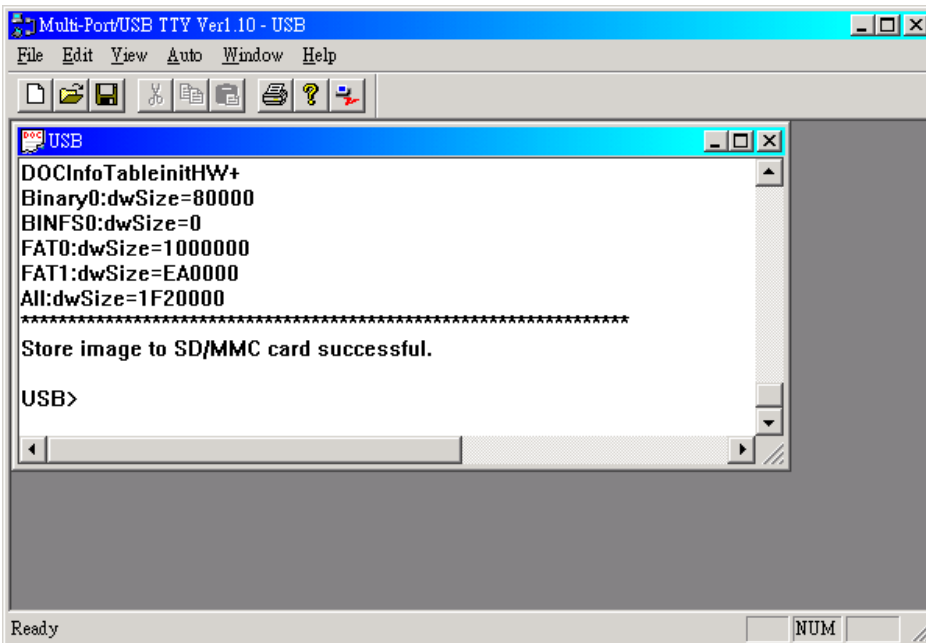

11. Take out the SD card from PDA phone and mark it according to the Language you build for.

#### 12.4 Procedure to Upgrade code/Re-Flash Unit.

*Use Pre-loaded SD card to Re-flash Unit.*

1. Insert Pre-loaded SD card to the unit . **Please pay attention not to format the SD card.**
2. Reset the unit and enter the boot loader mode , by pressing **Power + Action** key simultaneously and **Reset** the unit. Display will show....

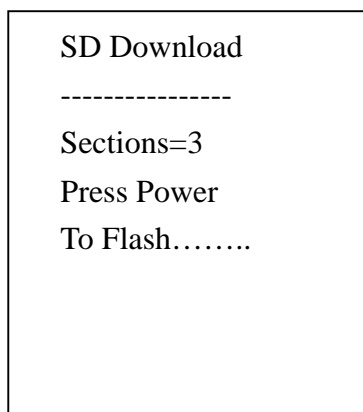

3. Follow the instruction on PDA phone by pressing Power to start flash.

4. Once it is Done, display will show

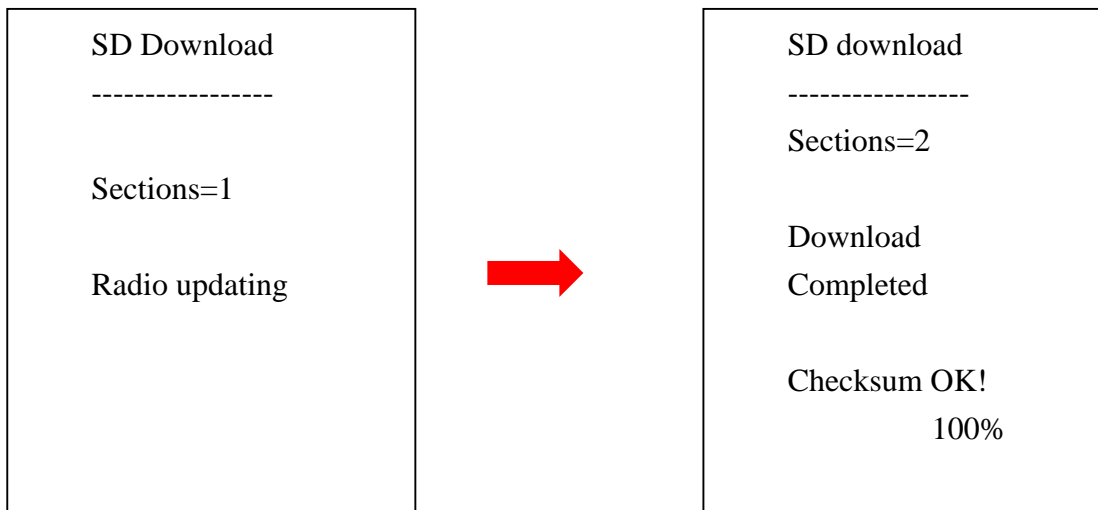

5. Take out the SD card and RESET the device (unit).

Now the upgrade procedure is **Done**.

**Note :** *Due to security issue, it is not allowed to re-flash different customer ID .*

### 13. Classification of Non-Conformity

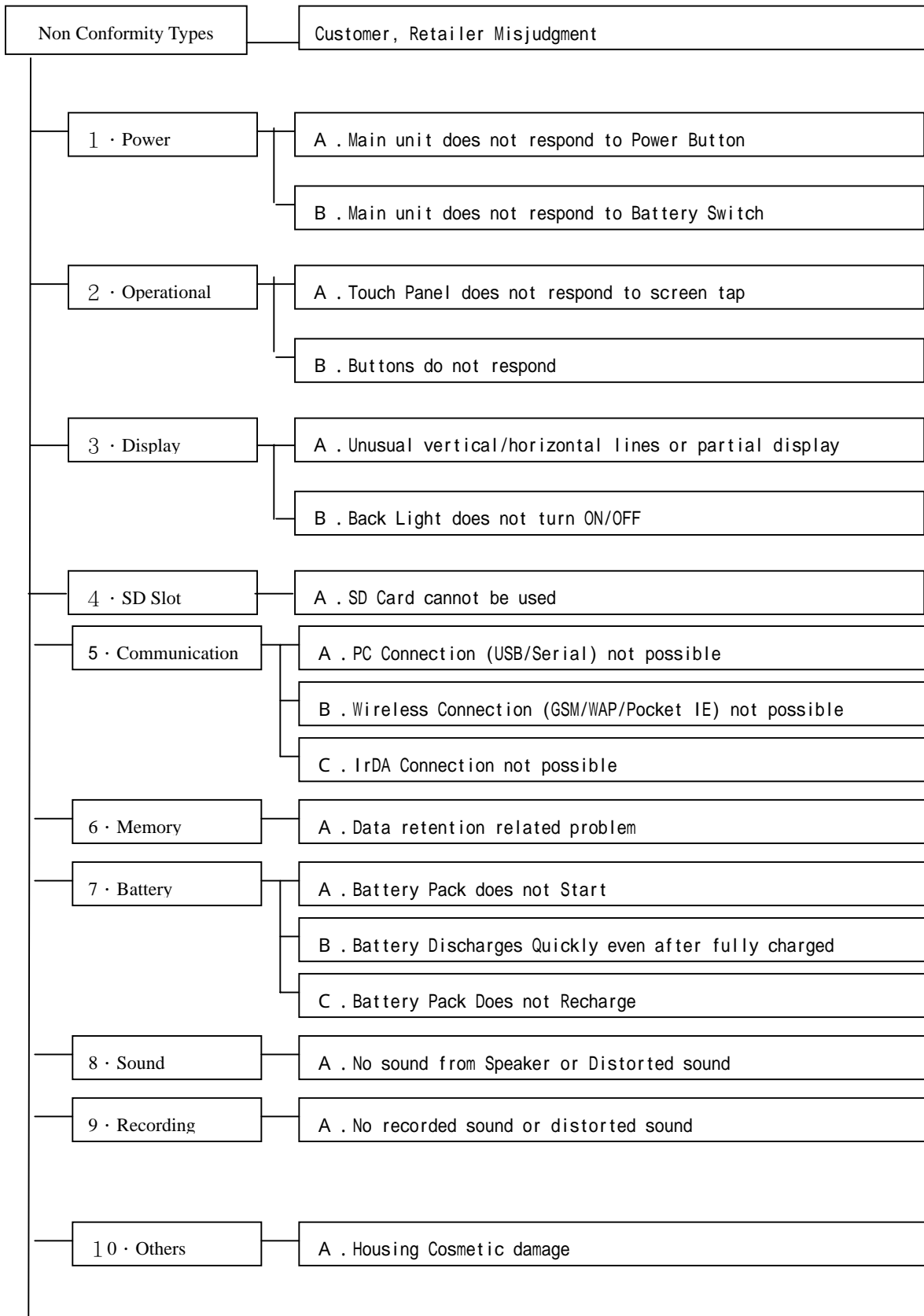

## 14. Troubleshooting & Repair

Before repairing , please try to duplicate if the symptom exist or Customer mishandling .

**1 – A · Main Unit Does Not Respond to Power Button**

**1 – B · Main Unit Does Not Respond to Battery Switch**

- (1) Make sure the Battery is installed properly to activate the battery pack.
- (2) Connect the AC Adapter, maybe the battery pack is exhaust.
- (3) Check the Battery lock is close properly.
- (4) Try with another battery pack.
- (5) Replace battery pack if necessary.
- (6) Try to enter boot loader mode, Perform Re-flash OS if successfully.
- (7) CMOS Camera is not assembled properly.
- (8) Check all connections including LCD FPC to Main Board. Try with another Main Board.
- (9) Fuse blown .
- (10) Customer abuse caused the power button fallen off
- (11) Both item 9 & 10 , MB replacement is necessary unless you are authorized to do board level repair.
- (12) Once the defective part has been identified, verify it again with the defective part whether the symptom could be duplicated.

**2 – A · Touch Panel Does Not Respond to Screen Tap**

- (1) Dismantle the unit, check the perimeter of Display between Front Bezel and Touch Panel surface for unusual foreign objects. Clean it, reassemble the unit and check the panel's function again.
- (2) Check the connection of LCM FPC whether is properly connected.
- (3) Try with another LCM.
- (4) Try with another Main Board.
- (5) Replace LCM if necessary
- (6) Replace Main Board if necessary.
- (7) Once the defective part has been identified, verify it again with the defective part whether the symptom could be duplicated.

### **2– B · Buttons Do Not Respond**

- (1) Dismantle the unit, check the status of switches on the Main Board and the plastic parts of button of the Button not responding.
- (2) Try with another Main Board or Front Bezel.
- (3) Replace Main Board or Front Bezel if necessary.
- (4) Once the defective part has been identified, verify it again with the defective part whether the symptom could be duplicated.
- (5) Hard Reset The unit.

### **3– A · Unusual Vertical / Horizontal lines or partial display**

- (1) Check the connection of LCM FPC whether is properly connected.
- (2) Try with another LCM.
- (3) Try with another Main Board.
- (4) Replace LCM if necessary
- (5) Replace Main Board if necessary.
- (6) Once the defective part has been identified, verify it again with the defective part whether the symptom could be duplicated.

### **3– B · Back Light Does Not Turn ON/OFF**

- (1) Check the connection of FPC whether is properly connected.
- (2) Try with another LCM.
- (3) Try with another Main Board.
- (4) Replace LCM if necessary
- (5) Replace Main Board if necessary.
- (6) Once the defective part has been identified, verify it again with the defective part whether the symptom could be duplicated.

#### **4– A · SD Card cannot be used**

- (1) Check whether SD or MMC Card is fully inserted to the slot until you hear a click.
- (2) Try with another SD / MMC Card and Check whether it is Write Protected.
- (3) Try with another Main Board.
- (4) Replace Main Board if necessary.
- (5) Once the defective part has been identified, verify it again with the defective part whether the symptom could be duplicated.

#### **5– A · PC Connection (USB / Serial) not possible**

- (1) Check whether "Connection Settings" in the MS ActiveSync is properly set.
- (2) Check whether it connects with other cables or cradle, customer's cable might be damaged.
- (3) Check the external appearance of the connector on the unit whether it is physically damaged.
- (4) Replace Main Board if necessary.
- (5) Once the defective part has been identified, verify it again with the defective part whether the symptom could be duplicated.

#### **5– B · Wireless Connection (GSM / WAP / GPRS) not possible**

- (1) Make sure the user has been contacting the Carrier for SIM Card validation and activation.
- (2) Make sure the Wireless Connection Settings has been properly set.
- (3) Make sure the SIM Card is properly inserted to the SIM compartment. Make a life call or test it with the RF Test Station (Antenna Test).
- (4) Dismantle the Main Unit and check whether the Antenna is properly installed.
- (5) Try with another Antenna.
- (6) Try with another Main Board if necessary.
- (7) Once the defective part has been identified, verify it again with the defective part whether the symptom could be duplicated.

#### **5– C · IrDA Connection not possible**

- (1) Make sure the IrDA port settings on the Notebook or PC are properly set.
- (2) Make sure the IrDA function is properly activated on the Pocket PC and on the other device.
- (3) Make sure there's no obstruction between the two devices in connection and within the distance.



- (4) Check the IrDA window whether it is broken or cracked. Replace Front Bezel if necessary.
- (5) Replace Main Board if necessary.
- (6) Once the defective part has been identified, verify it again with the defective part whether the symptom could be duplicated.

#### **6— A · Data Retention related problem**

- (1) Back up battery is rechargeable, to retention purpose when main battery power is used up or when changing the main battery, Make sure to charge the unit if not use for a while.
- (2) Data introduced by User might be lost when Battery has drained completely.
- (3) Ask user to charge the Main Unit when latest warning message pops up.
- (4) Ask users to back up their data to the PC or SD card when expect stop using the unit for long period of time, for example, more than one week.
- (5) Charge the Main Unit and check if data loses even the Battery pack is charged or at least The unit still can be powered on without AC Adapter.
- (6) Check whether AC Adapter is functioning properly.
- (7) Check whether the condition of Battery Charging status is correct.
- (8) Check the appearance of Battery Pack.
- (9) Replace Battery Pack if necessary
- (10) Replace Main Board if necessary.
- (11) Once the defective part has been identified, verify it again with the defective part whether the symptom could be duplicated.

#### **7— A · Battery Pack does not start**

- (1) Make sure the Battery lock is closed properly. Data introduced by User might be lost when Battery has drained completely.
- (2) Connect to the AC Adapter and see if it takes charge. Also check AC Adapter condition.
- (3) Ask users to back up their data to the PC or SD card when expect stop using the unit for long period of time, for example, more than one week.
- (4) Charge the Main Unit and check if data loses even the Battery pack is charged or at least The unit still can be powered on without AC Adapter.
- (5) Check whether AC Adapter is functioning properly.

- (6) Check whether the condition of Battery Charging status is correct.
- (7) Dismantle the unit and check the appearance of Battery Pack.
- (8) Try with another Battery Pack or Replace Battery Pack if necessary
- (9) Try with another Main Board or Replace Main Board if necessary.
- (10) Once the defective part has been identified, verify it again with the defective part whether the symptom could be duplicated.

#### **7– B · Battery discharges quickly even after fully charged**

- (1) Make sure the Battery Pack takes fully charge with AC Adapter.
- (2) Check whether the condition of Battery Charging status is correct.
- (3) Dismantle the unit and check the appearance of Battery Pack.
- (4) Try with another Battery Pack or Replace Battery Pack if necessary
- (5) Try with another Main Board or Replace Main Board if necessary.
- (6) Once the defective part has been identified, verify it again with the defective part whether the symptom could be duplicated.

#### **7– C · Battery Pack does not recharge**

- (1) Make sure the Battery Pack takes fully charge with AC Adapter.
- (2) Check whether the condition of Battery Charging status is correct. Charge should be done in no more than 3 hours.
- (3) Dismantle the unit and check the appearance of Battery Pack.
- (4) Try with another Battery Pack or Replace Battery Pack if necessary
- (5) Try with another Main Board or Replace Main Board if necessary.
- (6) Once the defective part has been identified, verify it again with the defective part whether the symptom could be duplicated.

#### **8– A · No Sound from Speaker or Distorted sound**

- (1) Check “Sound & Notifications” Settings in the unit for Sound Enabling.
- (2) Make sure it’s not MUTED.
- (3) Dismantle and Check whether the Speaker is properly installed (Orientation)
- (4) Make sure the connection point between MB and Speaker is free from contamination or dust.
- (5) Replace Speaker if necessary.

- (6) Replace Main Board if necessary.
- (7) Once the defective part has been identified, verify it again with the defective part whether the symptom could be duplicated.
- (8) Replace Camera if camera function was defect at the same time.

#### **9— A · No Recorded Sound or Distorted sound**

- (1) Check “Sound & Notifications” Settings in the unit for Sound Enabling.
- (2) Make sure it's not MUTED.
- (3) Dismantle and Check whether the Microphone is properly installed (check or missing rubber)
- (4) Replace Microphone if necessary.
- (5) Replace Main Board if necessary.
- (6) Once the defective part has been identified, verify it again with the defective part whether the symptom could be duplicated.
- (7) Replace Camera if camera function was defect at the same time.

#### **10— A · Housing Cosmetic damage**

- (1) Unless it is for Refurbishment, all housing replacement due to cosmetic damage shall be subject to be charged.

## 15. Exploded Diagrams & Spare part list

### 15.1 Exploded diagram

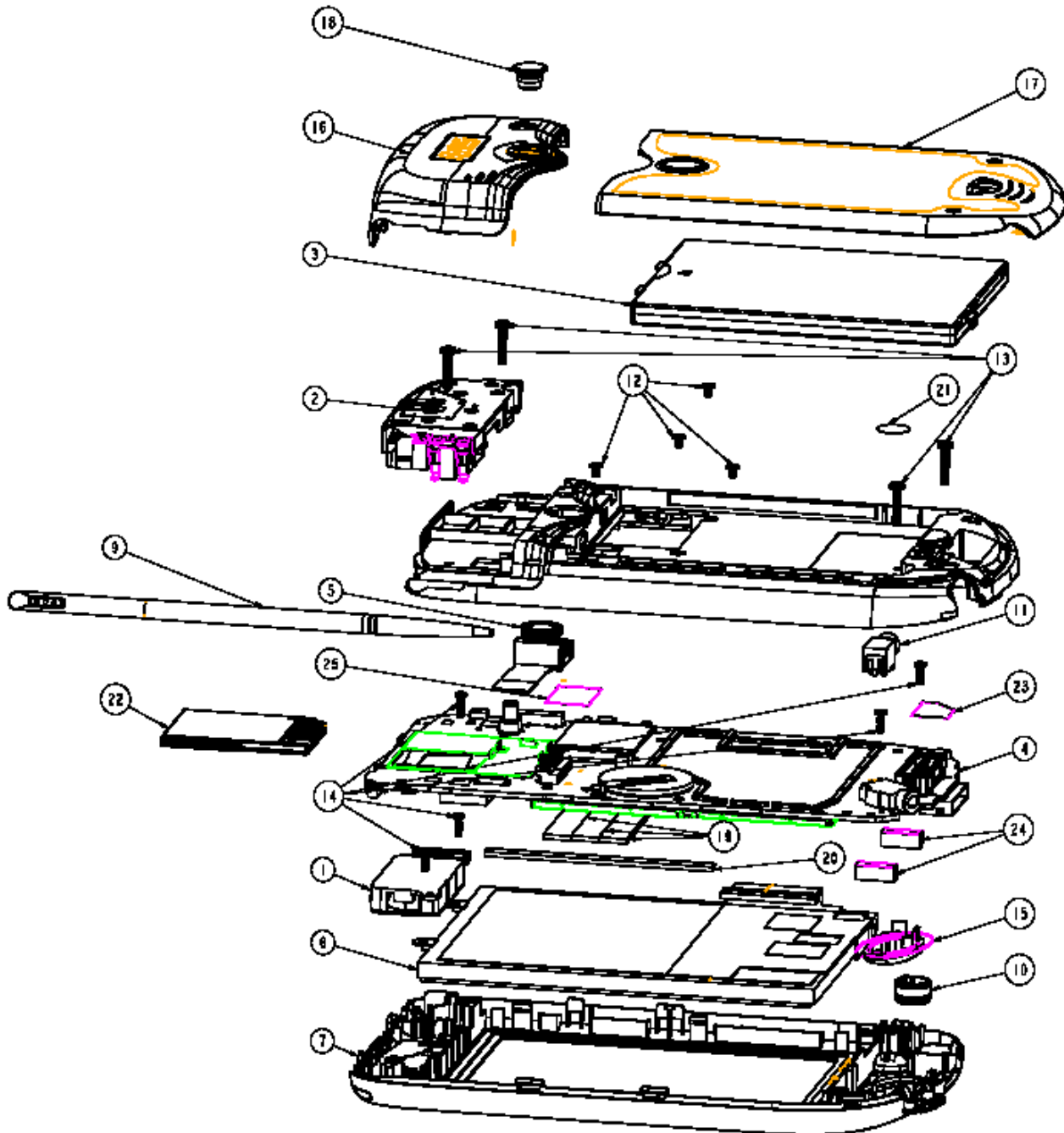

## 15.2 Spare part list

Item	Description	HTC P/N	Using Q'ty
1	Speaker,	36H00177-00	1
2	GSM ANTENNA	36H00158-00	1
3	RECHARGEABLE BATTERY,LI-ION polymer,3.7V,1200m	35H00020-01	1
4	FRU, Main Board, Phone, (Different Country has different P/N)	99HXXXX-XX	1
5	CMOS Camera Module	54H00063-00	1
6	LCM, ACX502AKN,SONY	60H00011-00	1
7	BEZEL, PRE-ASSY ,HIMALAYAS	74H00170-01	1
8	HOUSING, PRE-ASSY, HIMALAYAS	74H00171-03	1
9	STYLUS, HIMALAYAS	74H00187-00	1
10	MICROPHONE ASSY,MD6022ARC-9,W/RUBBER BOOT,EMKA	36H00132-00	1
11	Vibrator,Cylinder type,A4A-05-WTB-3,C.I.Kasei,	36H00180-00	1
12	SCREW,PH,FLAT,M1.4X2.5,NYLOK,L1.5	72H00338-00	4
13	SCREW,TOREX, M1.6x8,NYLOK,L4.5	72H00339-00	4
14	SCREW,PH,FLAT,1.4X4,PT,BLACK	72H00401-00	5
15	JOYPAD,PRE-ASSY,HIMALAYAS	74H00202-00	1
16	COVER,ANTENNA,PRE-ASSY,HIMALAYAS	74H00218-00	1
17	COVER,BATTERY,PRE-ASSY,HIMALAYAS	74H00219-00	1
18	RUBBER-COVER,ANTENNA-CONN,HIMALAYAS	76H00398-00	1
19	CONDUCTIVE-FABRIC,PCB,HIMALAYAS	72H00411-00	3
20	PORON,STYLUS,HIMALAYAS	76H00453-00	1
21	SECURITY LABEL,HIMALAYAS (WARRANTY SEAL)	77H00083-00	1
22	DUMMY, SD, CARD, HIMALAYAS	71H00651-00	1
23	INSULATOR,TAPE,PCB,HIMALAYAS	76H00469-00	1
24	PORON , PCB ,	76H00473-00	2
25	ALUMINUM-FOIL,CAMERA,HIMALAYAS ,stick on MB	72H00412-00	1

Besides of shown on exploded diagram, there are some more parts as following:

1	Conductive fabric, use on camera	72H00410-00	1
2	Insulation-tape, use on camera	76H00471-00	1

For More complete Spare Part List, Please visit HTC FTP or List Provided by HTC Logistic team, or contact with our Service Program Management.

HTC confidential

© 2001, HTC Corporation. All rights reserved.

TOTAL 77 CONT.ON. 70 PAGE NO. 69

**15.3 Spare Part List with Picture**

		
<p>1.Cover, Battery, 74H00219-00</p>	<p>2.GSM, Antenna, 36H00158-00</p>	<p>3.COVER, ANTENNA, 74H00218-00</p>
		
<p>4.Main Battery, 35H00020-01</p>	<p>5.Camera module, 54H00063-00</p>	<p>6. CONNECTOR, ADAPT, 75H00298-00</p>
		
<p>7. HOUSING, 74H00171-03</p>	<p>8.Main Board, 99HY2XXX-00 FRU,MB,ENG,GSM/GPRS, PDA PHONE.</p>	<p>9.FRU Unit,, 99HY2XXX-00 FRU,ENG,GSM/GPRS, PDA PHONE,</p>

		
<p>10.Regulatory label (Depend on model)</p>	<p>11. DUMMY, SD,CARD, 71H00651-00</p>	<p>12. STYLUS, 74H00187-00</p>

		
<p>13. LCM, 60H00011-00</p>	<p>14. MIC, 36H00132-00</p>	<p>15.JoyPad 74H00203-00</p>
		
<p>16.SCREW, TORX,M1.6x8 72H00339-00</p>	<p>17. Screw , 72H00338-00</p>	<p>18.SCREW, PH,FLAT,1.4X4 72H00401-00</p>
		
<p>19. Speaker, 36H00177-00</p>	<p>20.Vibrator, 36H00180-00</p>	<p>21.Back up battery, 35H00016-00</p>

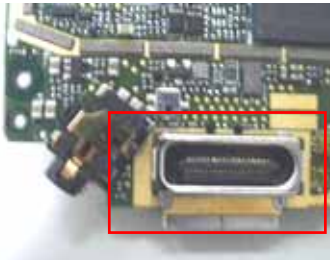
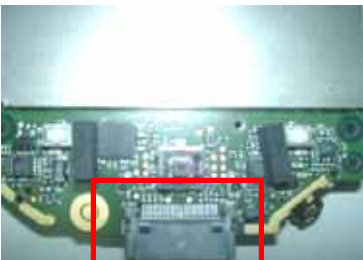
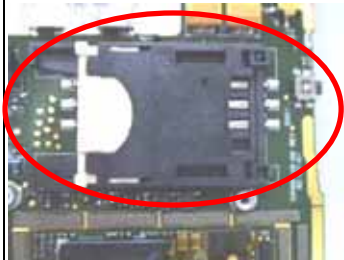
		
<p>22. Connector Docking,34P 75H00313-00</p>	<p>23. CONNECTOR-M,B-B, 22 PIN 75H00098-00</p>	<p>24.SIM Connector, 75H00319-00</p>

		
<p>25.CONDUCTIVE-FABRIC 72H00411-00</p>	<p>26.ALUMINUM-FOIL,CAMERA 72H00412-00</p>	<p>27.INSULATOR, TAPE, PCB, 76H00469-00</p>
		
<p>28. PORON, PCB 76H00473-00</p>	<p>29. AC ADAPTER, 79H00028-0X (depends on country)</p>	<p>30.RUBBER-COVER, ANTENNA, 76H00398-00</p>
		
<p>31. MYLAR,VOLUME button, 76H00483-00</p>	<p>32. Warning Label of SIM Conn 77H00119-00</p>	<p>33.SECURITY-LABEL (Warranty seal) 77H00083-00</p>



	35.	36.
34. Earphone 36H00169-00		

## 16. Appendix

### A. Customer, Retailer Misjudgment

Before attempt repairing the unit, make sure the type of reported failure could be clearly reproduced; otherwise, check with the customer or distributor once again to identify the problem correctly.

The following are failure symptoms that are typical by misjudgment

No.	Item	Possibility
1	No Power even the power button is pressed	Main Battery low power exhausted.
		While Back Light is turned OFF, the surrounding lighting will be reflected on the panel and in a dim location, it looks like the unit is turned OFF.
		According to the Power Management settings, the units will be switched OFF automatically.
2	Battery discharges quickly	The battery life depends on the devices being used in SD Card Slot, and frequency of use of the Back light. These functions consume a lot of energy.

		Operating with front light ON, or using high energy consumption devices such as SD Memory Card will drain out the battery pack faster.
3	Battery cannot be charged	<p>Using AC adapter that is NOT supplied with the unit.</p> <p>Charging the battery while operating the unit with heavy loadings could cause the temperature inside the unit to build up which could cause the unit stop charging. At this moment, the LED indicator will flash Yellow to notify user that the charging has been stopped. Or the temperature is extremely low will also stop charging.</p> <p>Since the extreme high or low temperature will cause the battery to discharge quickly, it has been designed to cut battery charge below 0°C and above 35~40°C to protect the battery pack.</p>
4	Cannot make communications via mobile phones through exclusive cable.	If the unit could pass the test with Loop back Interface card, the possibility of unit malfunction becomes low. Then the following items could be the reason of problem such as location, timing, signal strength, service provider's mixed up, or problem with the mobile itself. Or could be incompatibility issue.
5	Cannot use SD/CF Memory Card	<p>Cards which are not being pre-formatted.</p> <p>SD card has been switched to Write Protect mode.</p> <p>Card not inserted completely, or bad contact between connector contacts.</p>
6	Black or White dot on the screen.	For LCD panel's normal behavior, it is hard to find a panel without any bad pixel. Once the numbers of dots and the distance between them are within the specifications, it is allowed.

7	Touch Screen or Program Buttons are not reacting.	Could be wrong operation.
		Screen not properly aligned with the stylus calibration.
8	Front Light dim, cannot turn ON, or shuts OFF automatically.	Check the Front Light settings in Power Management settings
9	Cannot playback music, No sound or volume is low.	When Battery low, the music playback becomes difficult and the volume could become lower.
10	Cannot execute installed application programs	Could be an incompatible software
11	Operation is slow in response	Could be insufficient memory. Check amount of system memory.
12	Hang up	Software being used sometimes is not fully compatible with the system.
		Execute many application programs simultaneously
		Software that requires big amount of memory spaces or the system memory is low or the files being used is fragmented.
13	System Memory is enough, but is shows insufficient.	Software that requires big amount of memory spaces or the system memory is low or the files being used is fragmented.

***\*Note: Nevertheless, the above symptoms could be solved by a warm boot or cold boot, make sure the warm/cold boot has been executed and try to reproduce the symptom reported.***

**How to perform Warm Boot and Cold Boot :**

**Warm Boot :** Reset the unit by pressing reset button.

**Cold Boot :** Press Power button and Reset the unit simultaneously.

**More detail for troubleshooting and repair guide will be shown on training or release via FTP.**

**B. Repair Troubleshooting Guide FLOW.**

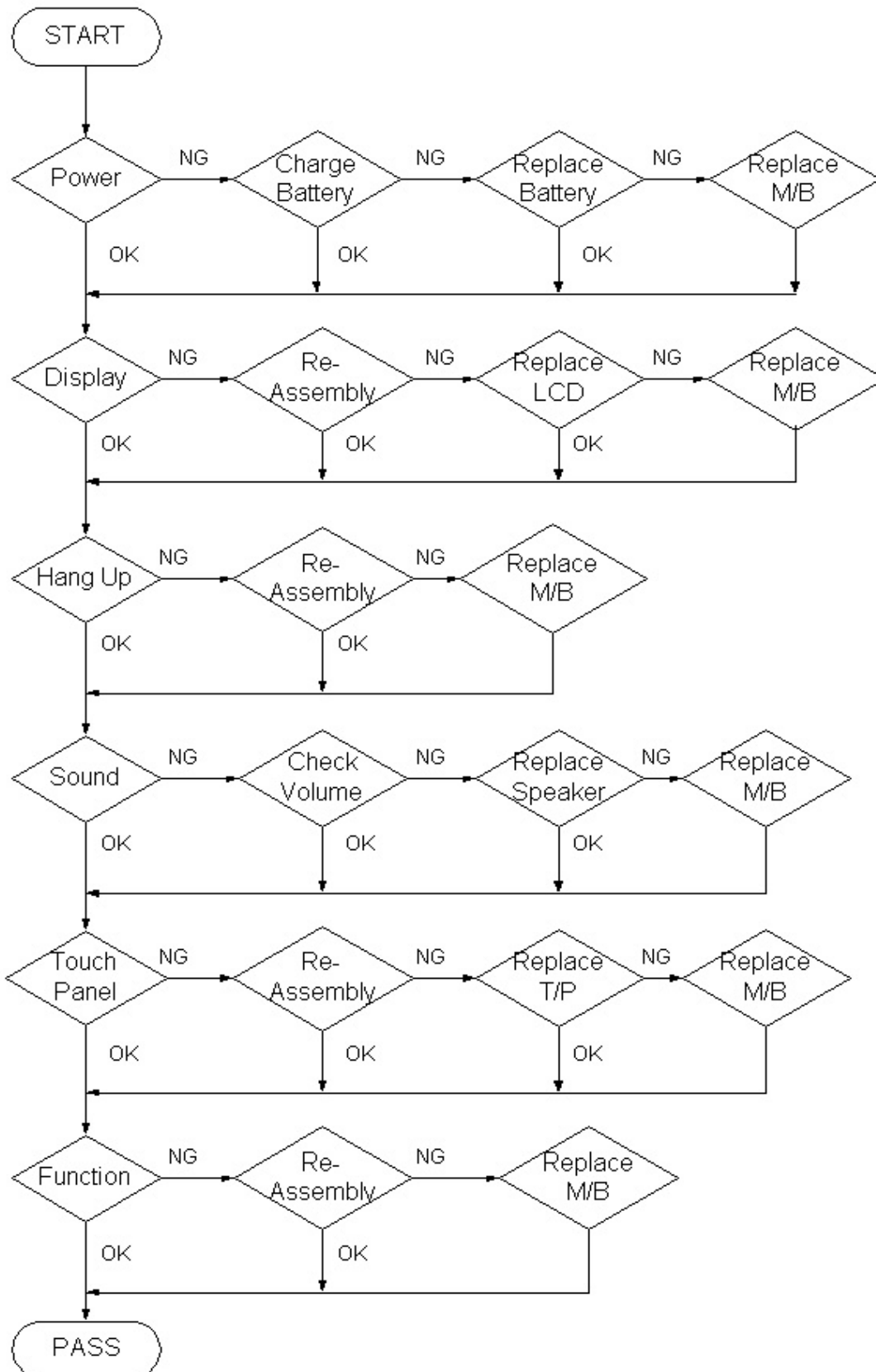



## Free Manuals Download Website

<http://myh66.com>

<http://usermanuals.us>

<http://www.somanuals.com>

<http://www.4manuals.cc>

<http://www.manual-lib.com>

<http://www.404manual.com>

<http://www.luxmanual.com>

<http://aubethermostatmanual.com>

Golf course search by state

<http://golfingnear.com>

Email search by domain

<http://emailbydomain.com>

Auto manuals search

<http://auto.somanuals.com>

TV manuals search

<http://tv.somanuals.com>