



**HUAWEI F685**

---

**Fixed Wireless Terminal**

# **USER GUIDE**

## **Copyright © Huawei Technologies Co., Ltd. 2011. All rights reserved.**

No part of this document may be reproduced or transmitted in any form or by any means without prior written consent of Huawei Technologies Co., Ltd.

The product described in this manual may include copyrighted software of Huawei Technologies Co., Ltd and possible licensors. Customers shall not in any manner reproduce, distribute, modify, decompile, disassemble, decrypt, extract, reverse engineer, lease, assign, or sublicense the said software, unless such restrictions are prohibited by applicable laws or such actions are approved by respective copyright holders under licenses.

### **Trademarks and Permissions**



HUAWEI, HUAWEI, and



are trademarks or registered trademarks of Huawei Technologies Co., Ltd.

Other trademarks, product, service and company names mentioned are the property of their respective owners.

### **Notice**

Some features of the product and its accessories described herein rely on the software installed, capacities and settings of local network, and may not be activated or may be limited by local network operators or network service providers. Thus the descriptions herein may not exactly match the product or its accessories you purchase.

Huawei Technologies Co., Ltd reserves the right to change or modify any information or specifications contained in this manual without prior notice or obligation.

### **NO WARRANTY**

THE CONTENTS OF THIS MANUAL ARE PROVIDED "AS IS". EXCEPT AS REQUIRED BY APPLICABLE LAWS, NO WARRANTIES OF ANY KIND, EITHER EXPRESS OR IMPLIED, INCLUDING BUT NOT LIMITED TO, THE IMPLIED WARRANTIES OF MERCHANTABILITY AND FITNESS FOR A PARTICULAR PURPOSE, ARE MADE IN RELATION TO THE ACCURACY, RELIABILITY OR CONTENTS OF THIS MANUAL.

TO THE MAXIMUM EXTENT PERMITTED BY APPLICABLE LAW, IN NO CASE SHALL HUAWEI TECHNOLOGIES CO., LTD BE LIABLE FOR ANY SPECIAL, INCIDENTAL, INDIRECT, OR CONSEQUENTIAL DAMAGES, OR LOST PROFITS, BUSINESS, REVENUE, DATA, GOODWILL OR ANTICIPATED SAVINGS.

### **Import and Export Regulations**

Customers shall comply with all applicable export or import laws and regulations and will obtain all necessary governmental permits and licenses in order to export, re-export or import the product mentioned in this manual including the software and technical data therein.

# Appearance

## Note:



The figures in this guide are provided for your reference only.

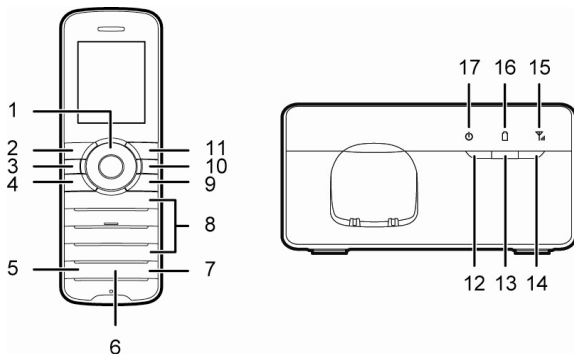

## Front View

Handset







Base



No.	Item	Description
1	Navigation keys ▲ ◀ OK ▶ ▼	<ul style="list-style-type: none"> <li>Access the main menu by pressing the <b>OK</b> key in standby mode.</li> <li>Access a shortcut menu by pressing the corresponding navigation key in standby mode.</li> <li>Adjust the volume by pressing the navigation keys during a call.</li> </ul>
2	Left function key	Select the option displayed in the lower left corner of the screen.
3	Speaker key 	Activate the hands-free mode to answer an incoming call.
4	Call/Send key 	<ul style="list-style-type: none"> <li>Make or answer a call.</li> <li>View the call log in standby mode.</li> </ul>
5	Mute key	Press this key to mute or unmute an ongoing call.
6	Shortcut key	Press this key to access the operator-customized function.
7	Intercommunication key	Press this key to access the list of registered handsets in standby mode.

No.	Item	Description
8	Number and symbol keys	<ul style="list-style-type: none"> <li>• Enter numbers, letters, and symbols.</li> <li>• Number keys (2–9): Speed-dial a user-assigned phone number by pressing and holding a key in standby mode.</li> <li>• # key: Switch between text input methods in editing mode.</li> <li>• * key: Display the symbol list in editing mode.</li> </ul>
9	End key 	<ul style="list-style-type: none"> <li>• End or reject a call.</li> <li>• Press and hold this key to power a handset on or off.</li> <li>• Return to the standby mode.</li> </ul>
10	Clear key 	Press this key to delete the character to the left of the cursor in editing mode.
11	Right function key	Select the option displayed in the lower right corner of the screen.
12	Power key	Press and hold this key to power the base on or off.
13	Page/Register key	<ul style="list-style-type: none"> <li>• Press this key to page a handset. This helps you to locate a handset that has been misplaced.</li> <li>• Press and hold this key to register a handset with the base.</li> </ul>
14	Reset key	Press and hold this key in standby mode to deregister all handsets from the base and restore the registration password to the default value. In this case, the base restarts automatically.
15	Signal indicator	<ul style="list-style-type: none"> <li>• Off: indicates that there is no signal or that the base is searching for a network or being initialized.</li> <li>• Steady on white: indicates that the signal is strong.</li> <li>• Blinking slowly in white: indicates a Subscriber Identity Module (SIM) card–related fault, such as no SIM card inserted, personal identification number (PIN) or PIN unblocking key (PUK) unverified, and SIM card unable to work properly.</li> </ul>
16	Battery indicator	<ul style="list-style-type: none"> <li>• Off: indicates that the battery has sufficient power or that the battery is not installed in the base.</li> <li>• Steady on red: indicates that the battery is being charged.</li> <li>• Blinking slowly in red: indicates that the battery power is insufficient and that you need to charge the battery.</li> <li>• Steady on green: indicates that the battery has been fully charged.</li> </ul>
17	Power indicator	<ul style="list-style-type: none"> <li>• Off: indicates that the base is powered off.</li> <li>• Steady on white: indicates that the base is powered on.</li> <li>• Blinking slowly in white: indicates that the base is in paging state.</li> <li>• Blinking fast in white: indicates that the base is registering a handset.</li> </ul>

## Screen Icons

Icon	Indicates...	Icon	Indicates...
	Signal strength		Battery level
	Alarm clock		Silent mode
	Unread message		Handset connected to the base
	Forwarding of all calls enabled		

## Installation

### Installing the SIM Card

Ensure that the base is powered off and disconnected from the power adapter. When installing the SIM card, ensure that the golden contacts of the SIM card are facing downward and that the beveled edge of the SIM card is properly aligned with that of the SIM card slot. Then check that the SIM card is fully inserted.

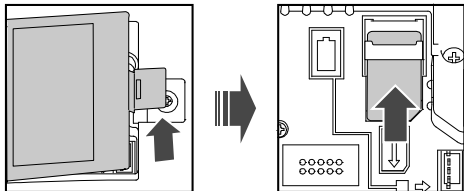

#### Note:

Do not remove or insert the SIM card frequently if the base works properly.

### Installing the Battery

Ensure that the phone is powered off and disconnected from the power adapter. When installing the battery, ensure that the golden contacts of the battery mate securely with those in the battery slot.

#### • Base:

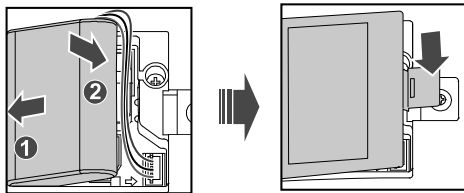

• **Handset:**

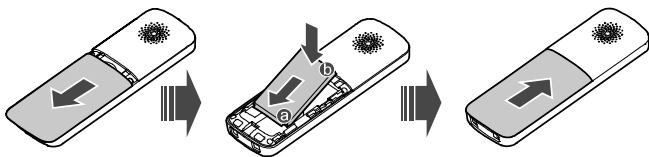

**Note:**

If the phone will not be used for a long time, remove the battery from the phone.

## Connecting the Power Adapter to the Base

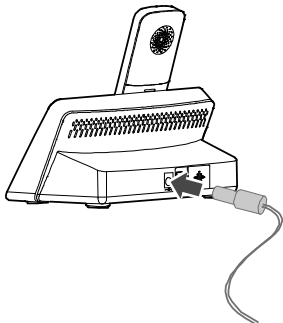

**Note:**

When new phones are delivered, the battery power is low. Therefore, charge the phone for a while and then power on the phone the first time you use it.

## Powering On the Phone

### Powering the Base On

To power the base on, press and hold the power key.

**Note:**

- The base will power on automatically after the power adapter is connected to it.
- To power the base off, press and hold the power key.

### Powering a Handset On

To power a handset on, press and hold the end key until the screen is lit up.

**Note:**

To power a handset off, press and hold the end key.

# Connecting a Handset to the Base

---

## Registering a Handset

Register a handset with the base before using it. Otherwise, you cannot use the handset.

To register a handset, do the following:

1. Press and hold the page/register key on the base until the power indicator blinks fast.
2. On the handset, select **Settings > Handset > Register handset**.
3. Select the base to be connected, and then enter the registration password.
4. Press the **OK** key to register the handset with the base.

### Note:

- The default registration password is **0000**. To change the password, select **Settings > Base > Security > System PIN**.
- When registering a handset with the base, ensure that the handset is near the base. After the handset is registered, use the handset within a certain distance of the base. Otherwise, the handset will display a message and disconnect from the base.
- You can register a maximum of six handsets with the base.

## Deregistering a Handset

To deregister a handset from the base, do the following:

1. Select **Settings > Handset > Deregister handset**.
2. Press the up and down navigation keys to scroll to the handset to be deregistered.
3. Press the **OK** key to deregister the handset from the base. You cannot use the handset after the handset is deregistered.

# Call Functions

---

## Making a Call

1. In standby mode, press the number keys to enter a phone number.
2. Press the call key to dial the number.
3. Press the end key to end the call or cancel the dialing.

### Note:

- In standby mode, press the call key to view the call log. Find the desired number in the call log, and then press the call key dial the number.
- Find the desired number in the contacts, and then press the call key to dial the number.

## Answering or Rejecting a Call

When there is an incoming call, press the call key to answer the call; press the end key to reject the call.

## Initiating an Internal Call

To initiate an internal call, do the following:

1. In standby mode, press the intercommunication key.
2. Press the up and down navigation keys to scroll to the handset to be connected.
3. Press the call key to initiate an internal call.

4. Press the end key to cancel or end the call.

## Transferring a Call

To transfer an ongoing call that is from the outside line to another handset, do the following:

1. Press the intercommunication key to scroll to the handset to which you want to transfer the call.
2. Press the call key to connect to the desired handset.
3. Press the end key to end the call between the current and desired handsets. The call is transferred to the desired handset.

## Messages

### Creating a Message

1. Select **Messages > Create message**.
2. Edit the message.
3. Press the **OK** key and then add a recipient using the following methods:
  - Enter the recipient's phone number.
  - Add the recipient from the contacts.
4. Press the **OK** key to send the message.

### Reading a Message

The phone stores received messages in the inbox.

1. Select **Messages > Inbox**.
2. Press the up or down navigation key to scroll to a message in the list.
3. Press the **OK** key to open and read the message.
4. Press the left function key to manage the message.

## Text Input Methods

### Switching Between Input Methods

In editing mode, press the **#** key to switch between input methods.

#### **Note:**

- In editing mode, you can press the clear key to delete the character to the left of the cursor or press and hold the clear key to delete all characters.
- In predictive or ordinary English input mode, you can press the **0** key to enter a space.
- In any input mode, press the **\*** key to display the symbol list.

### Predictive English Input (T9)

1. Press the keys labeled with the letters required to spell the desired word once according to the spelling sequence of the word.  
As you enter the letters, the handset predicts the desired word and displays candidate words.
2. Press the navigation keys to scroll to the desired word.
3. Press the **OK** key to enter the word followed by a space.



## Traditional English Input ("ABC" or "abc")

In "ABC" or "abc" text input mode, press the number keys to enter letters. Press a number key repeatedly until the desired character appears. If the next letter you want to enter is on the same key as the current one, wait until the current letter is entered, and then enter the next one.

## Number Input

In "123" input mode, enter a desired number by pressing the number key.

## Configuring Settings

---

To configure and customize your phone settings, select **Menu > Settings**.

### Phone Lock

To set the phone lock, select **Settings > Handset > Security > Phone password**. You can change the default phone lock code (**0000**) to a personal password.

#### Note:

Before restoring factory settings, you must enter the correct phone lock code.

### Keypad Lock

In standby mode, press and hold the # key to lock the keypad.

In standby mode, press the left function key and then the \* key to unlock the keypad.

### PIN and PUK

A Personal Identification Number (PIN) protects your SIM card from unauthorized use. A PIN Unlocking Key (PUK) is used to change a blocked PIN. If you enter your PIN incorrectly a number of times consecutively, your SIM card will be locked and the phone asks you to enter the PUK to unlock it. Both the PIN and the PUK are supplied with the SIM card. For details, contact your service provider.

## FAQs

---

If problems occur during the use of the phone, refer to the following sections for a proper solution. If a problem persists, contact your phone vendor.

### Phone Cannot Be Powered On

1. Remove the battery cover and check whether the battery is installed properly.
2. If the battery is properly installed, a possible cause for the problem is that the battery power is low. Charge the battery, and then try to power on the phone.

### No Information Is Displayed on the Phone Screen

If the phone is not used for a long time or the battery runs out of power, the phone may not display any information when it is being charged. This is a normal phenomenon. The phone can be powered on after the battery is charged for a while.

### Battery Cannot Be Charged

1. Check that the handset is properly connected to the base.
2. Check that the base and the power adapter are connected properly.
3. Check that the power adapter and the power socket are connected properly.
4. Replace the power adapter or the battery with a new one of the same model.

## Signal Strength Is Weak

1. Check that the SIM card is installed properly.
2. Place the phone at a location where strong signals can be received.

## Call Volume Is Too High or Too Low

During a call, press navigation keys to adjust the volume.

## Warnings and Precautions

---

This section contains important information pertaining to the operating instructions of your device. It also contains information about how to use the device safely. Read this information carefully before using your device.

### Electronic Device

Power off your device if using the device is prohibited. Do not use the device when using the device causes danger or interference with electronic devices.

### Medical Device

- Follow rules and regulations set forth by hospitals and health care facilities. Do not use your device when using the device is prohibited.
- Pacemaker manufacturers recommend that a minimum distance of 15 cm be maintained between a device and a pacemaker to prevent potential interference with the pacemaker. If you are using a pacemaker, use the device on the opposite side of the pacemaker and do not carry the device in your front pocket.
- Some wireless devices may affect the performance of hearing aids. For any such problems, consult your service provider.

### Potentially Explosive Atmosphere

Power off your device in any area with a potentially explosive atmosphere, and comply with all signs and instructions. Areas that may have potentially explosive atmospheres include the areas where you would normally be advised to turn off your vehicle engine. Triggering of sparks in such areas could cause an explosion or a fire, resulting in bodily injuries or even deaths. Do not power on your device at refueling points such as service stations. Comply with restrictions on the use of radio equipment in fuel depots, storage, and distribution areas, and chemical plants. In addition, adhere to restrictions in areas where blasting operations are in progress. Before using the device, watch out for areas that have potentially explosive atmospheres that are often, but not always, clearly marked. Such locations include areas below the deck on boats, chemical transfer or storage facilities, and areas where the air contains chemicals or particles such as grain, dust, or metal powders. Ask the manufacturers of vehicles using liquefied petroleum gas (such as propane or butane) whether this device can be safely used in their vicinity.

### Traffic Security

- Do not use your device while driving, and observe the local laws and regulations.
- Do not use your device while flying in an aircraft. Power off your device before boarding an aircraft. Using wireless devices in an aircraft may cause danger to the operation of the aircraft and disrupt the wireless telephone network. It may also be considered illegal.

### Operating Environment

- Do not use or charge the device in dusty, damp, and dirty places or places with magnetic fields. Otherwise, it may result in a malfunction of the circuit.

- On a stormy day with thunder, do not use your device, to prevent any danger caused by lightning.
- When you are on a call, do not touch the antenna. Touching the antenna affects the call quality and results in increase in power consumption. As a result, the talk time and the standby time are reduced.
- Use accessories authorized by the manufacturer. Using unauthorized accessories will render the warranty null and void.
- Because the device needs to disperse heat during working, place the device and the power supply in a ventilated and shady place. Never cover the device, put objects on it, or place it near water, fire as well as inflammable and explosive materials.
- For Base station: This device should be installed and operated with a minimum distance of 20 cm between the antenna and all persons.
- Keep the ambient temperature between -10°C and 45°C while the device is being charged. Keep the ambient temperature between -10°C to 55°C for using the device powered by a battery.

## Safety of Children

Comply with all precautions with regard to children's safety. Letting the child play with your device or its accessories, which may include parts that can be detached from the device, may be dangerous, as it may present a choking hazard. Ensure that small children are kept away from the device and accessories.

## Accessories

Choose only batteries, chargers, and accessories approved for use with this model by the device manufacturer. The use of any other type of battery, charger, or accessory may invalidate any warranty for the device, may be in violation of local rules or laws, and may be dangerous. Please contact your dealer for information about the availability of approved batteries, chargers, and accessories in your area.

## Battery and Charger

- Unplug the charger from the electrical plug and the device when not in use.
- Do not connect two poles of the battery with conductors, such as metal materials, keys, or jewelries. Otherwise, the battery may be short-circuited and may cause injuries and burns on your body.
- Do not disassemble the battery or solder the battery poles. Otherwise, it may lead to electrolyte leakage, overheating, fire, or explosion.
- If battery electrolyte leaks out, ensure that the electrolyte does not touch your skin and eyes. When the electrolyte touches your skin or splashes into your eyes, wash your eyes with clean water immediately and consult a doctor.
- If there is a case of battery deformation, color change, or abnormal heating while you charge or store the battery, remove the battery immediately and stop using it. Otherwise, it may lead to battery leakage, overheating, explosion, or fire.
- If the power cable is damaged (for example, the cord is exposed or broken), or the plug loosens, stop using the cable at once. Otherwise, it may lead to an electric shock, a short circuit of the charger, or a fire.
- Do not dispose of batteries in fire as they may explode. Batteries may also explode if damaged.
- Danger of explosion if battery is incorrectly replaced. Recycle or dispose of used batteries according to the local regulations or reference instruction supplied with your device.

## Cleaning and Maintenance

- The device, battery, and charger are not water-resistant. Keep them dry. Protect the device, battery, and charger from water or vapor. Do not touch the device or the charger with a wet hand. Otherwise, it may lead to a short circuit, a malfunction of the device, and an electric shock to the user.
- Do not place your device, battery, and charger in places where they can get damaged because of collision. Otherwise, it may lead to battery leakage, device malfunction, overheating, fire, or explosion.
- Do not place magnetic storage media such as magnetic cards and floppy disks near the device. Radiation from the device may erase the information stored on them.
- Do not leave your device, battery, and charger in a place with an extreme high or low temperature. Otherwise, they may not function properly and may lead to a fire or an explosion.
- Do not place sharp metal objects such as pins near the earpiece. The earpiece may attract these objects and hurt you when you are using the device.
- Before you clean or maintain the device, power off the device and disconnect it from the charger.
- Do not use any chemical detergent, powder, or other chemical agents (such as alcohol and benzene) to clean the device and the charger. Otherwise, parts of the device may be damaged or a fire can be caused. You can clean the device and the charger with a piece of damp and soft antistatic cloth.
- Do not dismantle the device or accessories. Otherwise, the warranty on the device and accessories is invalid and the manufacturer is not liable to pay for the damage.

## Emergency Call

You can use your device for emergency calls in the service area. The connection, however, cannot be guaranteed in all conditions. You should not rely solely on the device for essential communications.

## Disposal and Recycling Information



This symbol on the device (and any included batteries) indicates that they should not be disposed of as normal household garbage. Do not dispose of your device or batteries as unsorted municipal waste. The device (and any batteries) should be handed over to a certified collection point for recycling or proper disposal at the end of their life.

For more detailed information about the recycling of the device or batteries, contact your local city office, the household waste disposal service, or the retail store where you purchased this device.

The disposal of this device is subject to the Waste from Electrical and Electronic Equipment (WEEE) directive of the European Union. The reason for separating WEEE and batteries from other waste is to minimize the potential environmental impacts on human health of any hazardous substances that may be present.

## Reduction of Hazardous Substances

This device is compliant with the EU Registration, Evaluation, Authorisation and Restriction of Chemicals (REACH) Regulation (Regulation No 1907/2006/EC of the European Parliament and of the Council) and the EU Restriction of Hazardous Substances (RoHS) Directive (Directive 2002/95/EC of the European Parliament and of the Council). For more information about the REACH compliance of the device, visit the Web site [www.huaweidevice.com/certification](http://www.huaweidevice.com/certification). You are recommended to visit the Web site regularly for up-to-date information.

## EU Regulatory Conformance

Hereby, Huawei Technologies Co., Ltd. declares that this device is in compliance with the essential requirements and other relevant provisions of Directive 1999/5/EC.

For the declaration of conformity, visit the Web site [www.huaweidevice.com/certification](http://www.huaweidevice.com/certification).

**CE0168**

Notice: Observe the national local regulations in the location where the device is to be used. This device may be restricted for use in some or all member states of the European Union (EU).

## Free Manuals Download Website

<http://myh66.com>

<http://usermanuals.us>

<http://www.somanuals.com>

<http://www.4manuals.cc>

<http://www.manual-lib.com>

<http://www.404manual.com>

<http://www.luxmanual.com>

<http://aubethermostatmanual.com>

Golf course search by state

<http://golfingnear.com>

Email search by domain

<http://emailbydomain.com>

Auto manuals search

<http://auto.somanuals.com>

TV manuals search

<http://tv.somanuals.com>