



HUAWEI ME909u-521 LTE LGA Module

Application Guide

Issue 01
Date 2013-07-05

Huawei Technologies Co., Ltd. provides customers with comprehensive technical support and service. For any assistance, please contact our local office or company headquarters.

Huawei Technologies Co., Ltd.

Huawei Industrial Base, Bantian, Longgang, Shenzhen 518129, People's Republic of China

Tel: +86-755-28780808 Global Hotline: +86-755-28560808 Website: www.huawei.com

E-mail: mobile@huawei.com

Please refer color and shape to product. Huawei reserves the right to make changes or improvements to any of the products without prior notice.

Copyright © Huawei Technologies Co., Ltd. 2013. All rights reserved.

No part of this document may be reproduced or transmitted in any form or by any means without prior written consent of Huawei Technologies Co., Ltd.

The product described in this manual may include copyrighted software of Huawei Technologies Co., Ltd and possible licensors. Customers shall not in any manner reproduce, distribute, modify, decompile, disassemble, decrypt, extract, reverse engineer, lease, assign, or sublicense the said software, unless such restrictions are prohibited by applicable laws or such actions are approved by respective copyright holders under licenses.

Trademarks and Permissions



HUAWEI,

HUAWEI, and



are trademarks or registered trademarks of Huawei Technologies Co., Ltd.

Other trademarks, product, service and company names mentioned are the property of their respective owners.

Notice

Some features of the product and its accessories described herein rely on the software installed, capacities and settings of local network, and may not be activated or may be limited by local network operators or network service providers, thus the descriptions herein may not exactly match the product or its accessories you purchase.

Huawei Technologies Co., Ltd reserves the right to change or modify any information or specifications contained in this manual without prior notice or obligation.

NO WARRANTY

THE CONTENTS OF THIS MANUAL ARE PROVIDED "AS IS". EXCEPT AS REQUIRED BY APPLICABLE LAWS, NO WARRANTIES OF ANY KIND, EITHER EXPRESS OR IMPLIED, INCLUDING BUT NOT LIMITED TO, THE IMPLIED WARRANTIES OF MERCHANTABILITY AND FITNESS FOR A PARTICULAR PURPOSE, ARE MADE IN RELATION TO THE ACCURACY, RELIABILITY OR CONTENTS OF THIS MANUAL.

TO THE MAXIMUM EXTENT PERMITTED BY APPLICABLE LAW, IN NO CASE SHALL HUAWEI TECHNOLOGIES CO., LTD BE LIABLE FOR ANY SPECIAL, INCIDENTAL, INDIRECT, OR CONSEQUENTIAL DAMAGES, OR LOST PROFITS, BUSINESS, REVENUE, DATA, GOODWILL OR ANTICIPATED SAVINGS.

Import and Export Regulations

Customers shall comply with all applicable export or import laws and regulations and will obtain all necessary governmental permits and licenses in order to export, re-export or import the product mentioned in this manual including the software and technical data therein.



About This Document

Revision History

Document Version	Date	Chapter	Description
01	2013-07-05		Creation



Contents

1 Overview	7
1.1 Conventions and Definitions	7
1.1.1 Conventions	7
1.1.2 Definitions	7
1.2 Organization of This Document	8
1.3 Basic AT Command Processing Principles	9
1.3.1 Ports	9
1.3.2 AT Command Processing Mechanism	9
1.3.3 Recommended Timeout Mechanism for AT Commands Processed by a Host	12
2 Initialization Application Scenarios	14
2.1 Startup Indication ^SYSSTART	14
2.1.1 Reference Process	14
2.1.2 Troubleshooting	14
2.2 Querying Basic Information	15
2.2.1 Reference Process	15
2.2.2 Troubleshooting	15
2.3 Network Service Operations	16
2.3.1 Reference Process	16
2.3.2 Troubleshooting	17
3 Network Searching and Registration Application Scenarios	18
3.1 Searching and Registering Network	18
3.1.1 Reference Process	18
3.1.2 Troubleshooting	20
4 ECM Application Scenarios	21
4.1 ECM Dialing	21
4.1.1 Reference Process	21
4.1.2 Troubleshooting	22
4.2 Querying the Dial-up Connection State	22
4.2.1 Reference Process	22
4.2.2 Troubleshooting	23
4.3 Disconnecting the Dial-up Connection	23
4.3.1 Reference Process	23



4.3.2 Troubleshooting	23
5 SMS Application Scenarios	24
5.1 Overview	24
5.2 Initializing SMS.....	26
5.2.1 Reference Process	26
5.2.2 Troubleshooting	29
5.3 Sending Short Message.....	29
5.3.1 Reference Process	29
5.3.2 Troubleshooting	31
5.4 Reading Short Messages.....	32
5.4.1 Reference Process	32
5.4.2 Troubleshooting	34
5.5 Deleting Short Messages	34
5.5.1 Reference Process	34
5.5.2 Troubleshooting	35
6 Phonebook Application Scenarios	36
6.1 Overview	36
6.2 Memory Operations.....	36
6.2.1 Reference Process	36
6.2.2 Troubleshooting	37
6.3 Reading Phonebook Entries	38
6.3.1 Reference Process	38
6.3.2 Troubleshooting	39
6.3.3 Writing/Deleting Phonebook Entries.....	40
6.3.4 Reference Process	40
6.3.5 Troubleshooting	41
6.4 Searching for Phonebook Entries	42
6.4.1 Reference Process	42
6.4.2 Troubleshooting	43
6.5 Querying User Number	43
6.5.1 Reference Process	43
6.5.2 Troubleshooting	44
6.6 Setting the TE's Character Sets	44
6.6.1 Reference Process	44
6.6.2 Troubleshooting	45
7 SIM Operation Application Scenarios.....	46
7.1 PIN Operations.....	46
7.1.1 Reference Process	46
7.1.2 Troubleshooting	47
7.2 CRSM Command	48
7.2.1 Reference Process	48



7.2.2 Troubleshooting	50
8 Sleeping and Waking Up Application Scenarios	51
8.1 Hardware Interfaces	52
8.2 Sequence Diagram.....	53
8.3 Software Interfaces	54
8.3.1 Principle	54
8.3.2 USB and Sleep	56
8.3.3 UART and Sleep.....	57
8.3.4 Module Wake-up.....	57
8.3.5 Host Woken up by Module	57
8.4 Application Scenarios: System with USB Connection only	59
8.4.1 Hardware Connection.....	59
8.4.2 Software Procedure	59
8.4.3 Advantages	60
8.5 Application Scenarios: System with USB and WAKEUP_OUT.....	60
8.5.1 Hardware Connection.....	60
8.5.2 Software Procedure	60
8.5.3 Advantages	61
8.6 System with Other Connection Methods.....	61
9 Thermal Protection Application Scenarios	62
9.1 Pre-configuration	62
9.1.1 Troubleshooting	62
9.2 Thermal Protection Process.....	62
10 Module Powering Off and Resetting Application Scenarios.....	64
10.1 Restarting the ME.....	64
10.1.1 Reference Process	64
10.1.2 Troubleshooting	64
10.2 Power Off ME	64
10.2.1 Reference Process	64
10.2.2 Troubleshooting	65
11 Appendix	66
11.1 Relative Documents	66
11.2 Acronyms and Abbreviations	66

1 Overview

This document is intended to provide references for customers to choose appropriate command sequences to start using the ME909u-521 module in a faster manner. This document also contains examples and relevant description.

This document will be updated based on customers' requirements.

1.1 Conventions and Definitions

1.1.1 Conventions

Convention	Description
<...>	Value range of AT command parameters
XXXX	Personal Identification Number (PIN), Personal Unlock Key (PUK), or password

1.1.2 Definitions

Term	Definition
Connected	Indicates that a link has been set up between two modules or a module and a terminal.
Registered	Indicates that the module is registered with a LTE/UMTS/GSM network.
Module	HUAWEI LTE module

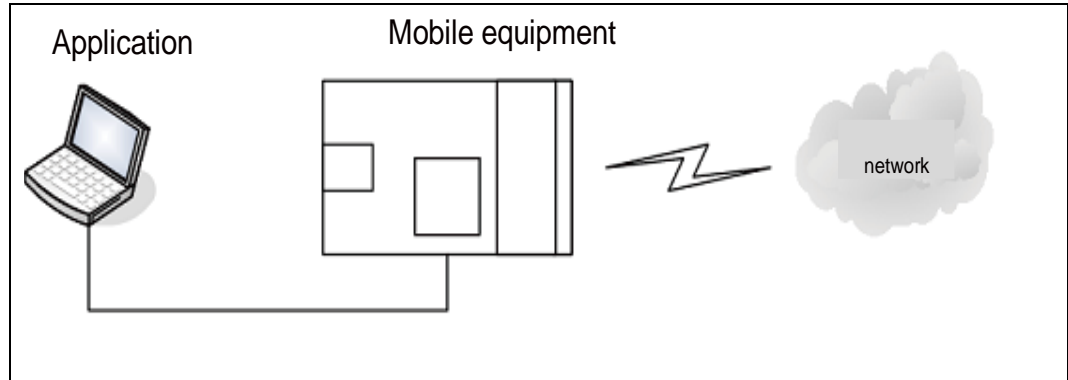

1.2 Organization of This Document

Chapter	Description
Chapter 1 Overview	Describes the contents and organization of this document
Chapter 2 Initialization Application Scenarios	Describes scenarios for initialization
Chapter 3 Network Searching and Registration Application Scenarios	Describes scenarios for network searching and registration
Chapter 4 ECM Application Scenarios	Describes scenarios for ECM
Chapter 5 SMS Application Scenarios	Describes scenarios for the text message
Chapter 6 Phonebook Application Scenarios	Describes scenarios for phonebook
Chapter 7 SIM Operation Application Scenarios	Describes scenarios for PIN management
Chapter 8 Sleeping and Waking Up Application Scenarios	Describes scenarios for power management
Chapter 9 Thermal Protection Application Scenarios	Describes scenarios for thermal protection
Chapter 10 Module Powering Off and Resetting Application Scenarios	Describes scenarios for powering off and restarting
Chapter 11 Appendix	Appendix

1.3 Basic AT Command Processing Principles

1.3.1 Ports

The ME909u-521 module provides three ports to interact with its host:

- MODEM port: simulated using USB, for AT command interaction and establishing data connection.
Port name: HUAWEI Mobile Connect-3G Modem
- PCUI port: simulated using USB, for AT command interaction only.
Port name: HUAWEI Mobile Connect-3G PCUI Interface
- ECM port: simulated using USB, for establishing communication connection.
Port name: CDC Ethernet Control Model (ECM)

The ME909u-521 also provides a port for debugging:

- DIAG port: Simulated using USB, for DIAG (diagnostic) command interaction (mainly used to debug modules at present).
Port name: HUAWEI Mobile Connect-3G Application Interface

A host controls a module using AT commands. If AT commands are unavailable, a module can be deemed as unavailable.

1.3.2 AT Command Processing Mechanism

A module processes AT commands from the ports (MODEM, PCUI) in series. An AT command can be processed when and only when the previous AT command processing has been completed. If the module is processing an AT command, a new AT command from the same port will be ignored and other commands from other ports will be buffered until the current AT command is processed.

This rule also applies to COM ports converted from USB ports.

The processing of an AT command starts when the AT command is entered from the TE, and ends when the UE (the module) returns all the results in response the command.

Figure 1-1 AT command processing sequence diagram

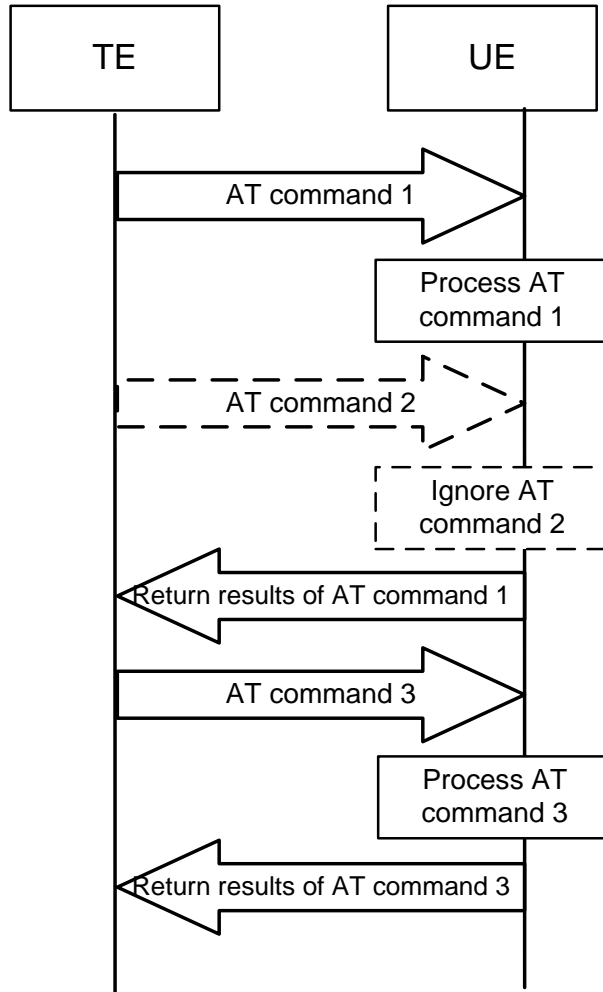

Example:

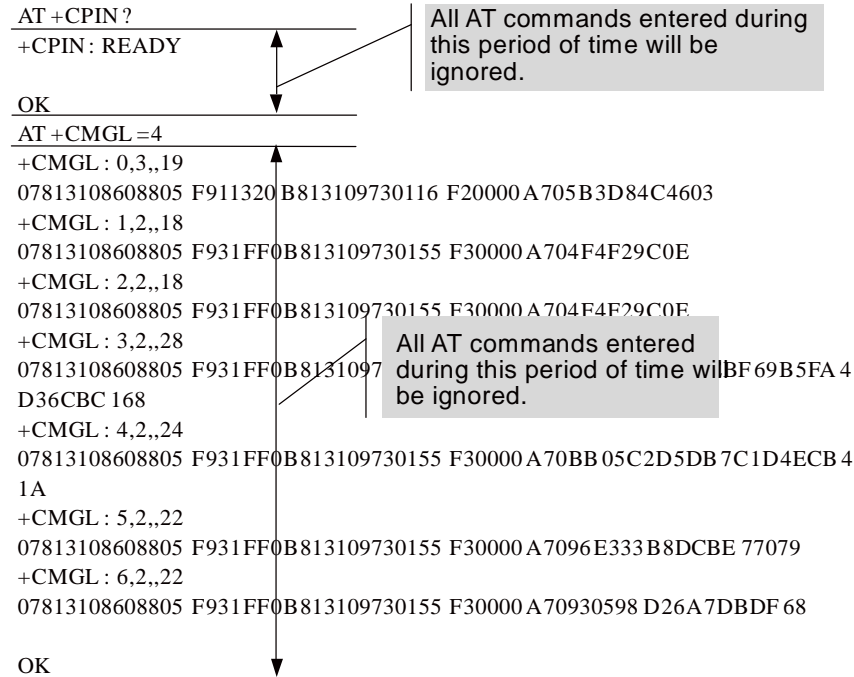

Some special AT commands can be aborted by new AT commands. Such special commands are called abortive commands.

The ME909u-521 supports the following abortive AT commands:

- The AT+COPS Set command
- AT+CLCK

Example:

```
AT+COPS=1,2,23415
OK
```

Before the results of AT+COPS is returned, enter any characters (such as "AT"), the module will terminate the processing of AT+COPS and return **OK**. The entered characters are used to abort the command only .

Some commands can be executed when SIM card is inserted. It would return to SIM failure if SIM card is not inserted. For more information, see Property Description of related AT in [HUAWEI ME909u-521 LTE LGA Module AT Command Interface Specification](#).

Example:

```
AT+CREG?
+CME ERROR: SIM failure
```

Note:

SIM failure indicate that SIM card is not inserted.

1.3.3 Recommended Timeout Mechanism for AT Commands Processed by a Host

A module processes AT commands in series. Do not send another AT command before the result for the current command is returned or the current command times out (except when the current command is an abortive AT command). The following table lists AT command timeout durations (starting from the time when an AT command arrives at a port).

Table 1-1 AT command timeout duration

AT Command	Timeout Duration
General AT commands	30s
AT+CMSS/AT+CMGS (used to send text messages)	60s
AT+COPS=? (used to search for networks)	120s

After an AT command times out, it is recommended that the host check whether the module is functioning normally. The following procedure is provided for your reference:

1. The host sends **AT** to the module.



2. If the module returns failure information, go to step 5.
3. If the module returns success information, the module is functioning normally.
4. If the host times out (the host waits for a response for over 30 seconds) three times when waiting for the response from the module, go to step 5. Otherwise go to step 1.
5. The host deems that the current module does not exist or is unavailable. Close the port, stop sending all AT commands, exit the procedure to determine whether the module is normal, and re-search for modules.

2 Initialization Application Scenarios

2.1 Startup Indication ^SYSSTART

2.1.1 Reference Process

Command	Description
	A module, without solicitation, presents ^SYSSTART to its host to indicate that the module is starting.
^SYSSTART	Indicate that a module is starting.

Notes:

- **^SYSSTART** is presented only when a module is starting and will not be presented after a module has started.
- **^SYSSTART** is presented only after the radio frequency (RF) initialization completes and will not be presented in offline mode.

2.1.2 Troubleshooting

Scenario	Possible Error Information	Solution
The module presents ^SYSSTART during startup. After that, the module presents ^SYSSTART again.	Indicate that the module has been reset.	If ^SYSSTART is presented repeatedly, send the module to the specified repair center.



2.2 Querying Basic Information

2.2.1 Reference Process

Command	Description
AT+GMR/CGMR	Query software version.
Software version	Software version. e.g. 11.103.03.00.00
OK	
AT+GMI/CGMI	Query manufacturer identification.
Manufacturer Identification	For example: Huawei Technologies Co., Ltd.
OK	
AT+GMM/CGMM	Query model identification.
Model identification	For example: ME909u-521
OK	
AT+GSN/CGSN	Query product IMEI.
IMEI	For example: 865261010004010
OK	

Note:

The previously listed commands are Query commands and cannot be used to configure settings.

2.2.2 Troubleshooting

Scenario	Possible Error Information	Solution
AT+GSN/CGSN	+CME ERROR: memory failure	This error occurs when a module's IMEI is not specified. This problem is solved after the IMEI is written into the module.



2.3 Network Service Operations

2.3.1 Reference Process

Command	Description
AT+CFUN?	Query a module's current mode. 1 indicates online mode.
+CFUN: 1	
OK	
AT+CPIN?	Query whether a module's SIM card is password protected. READY indicates that the SIM card is ready.
+CPIN: READY	
OK	
AT^HCSQ?	Query the network signal quality.
^HCSQ: "WCDMA",30,30,58	
OK	
AT+COPS?	Return the current network selection mode, information about the operator with which the module is registered, and the wireless access standard.
+COPS: "Network status information"	For example: +COPS: 1,0, "China Mobile Com"
OK	
AT+COPS=0	Automatically search for networks.
OK	
AT+CREG?	Query the state of the currently registered network.
+CREG: 0,1	
OK	
AT+CREG=1	Set the +CREG unsolicited indication.
OK	



2.3.2 Troubleshooting

Scenario	Possible Error Information	Solution
AT+COPS?	+CME ERROR: SIM failure	No SIM card is detected. Insert a SIM card.
AT+CREG?	+CME ERROR: SIM failure	No SIM card is detected. Insert a SIM card.

3 Network Searching and Registration Application Scenarios

3.1 Searching and Registering Network

3.1.1 Reference Process

Command	Description
AT+COPS=0 OK	Enable automatic search for networks.
AT+COPS=1,2,"46000" OK	Manual search for the appointed network.
AT+COPS=? OK	Search for all networks, and return the networks.
AT+CREG=2 OK	Enable the unsolicited indication when network registration state changes.
AT^SYSCFGEX="00",3FFFFFFF,1,2,7FFFFFFFFFFFFFFF,, OK	Set the system mode, network access order, frequency band, roaming support, domain, and other features.
AT^SYSINFOEX ^SYSINFOEX: 2,3,0,1,,1,"GSM",3,"EDGE" OK	Query the system service state, domain, roaming status, and system mode.
AT^HCSQ?	Query the signal quality.

Command	Description
<code>^HCSQ:"GSM",73</code>	
OK	

Figure 3-1 Automatic search for networks

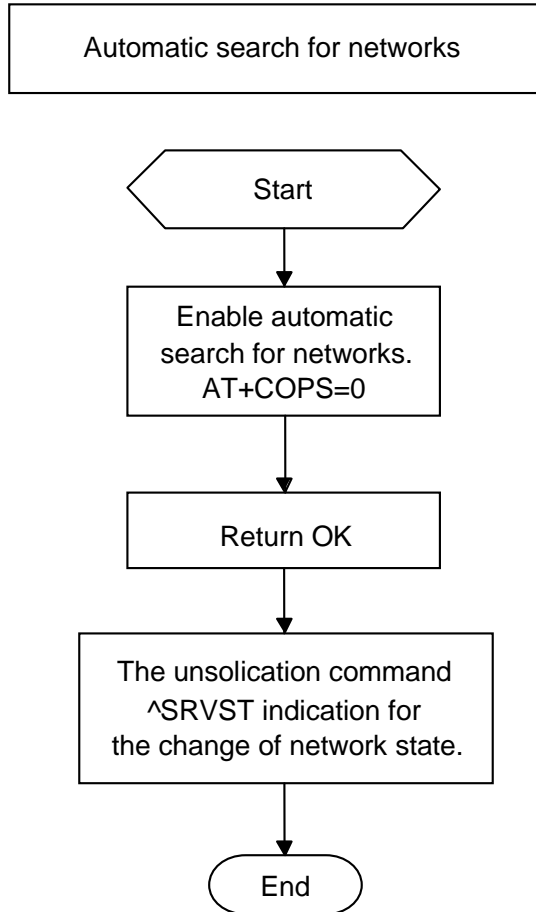
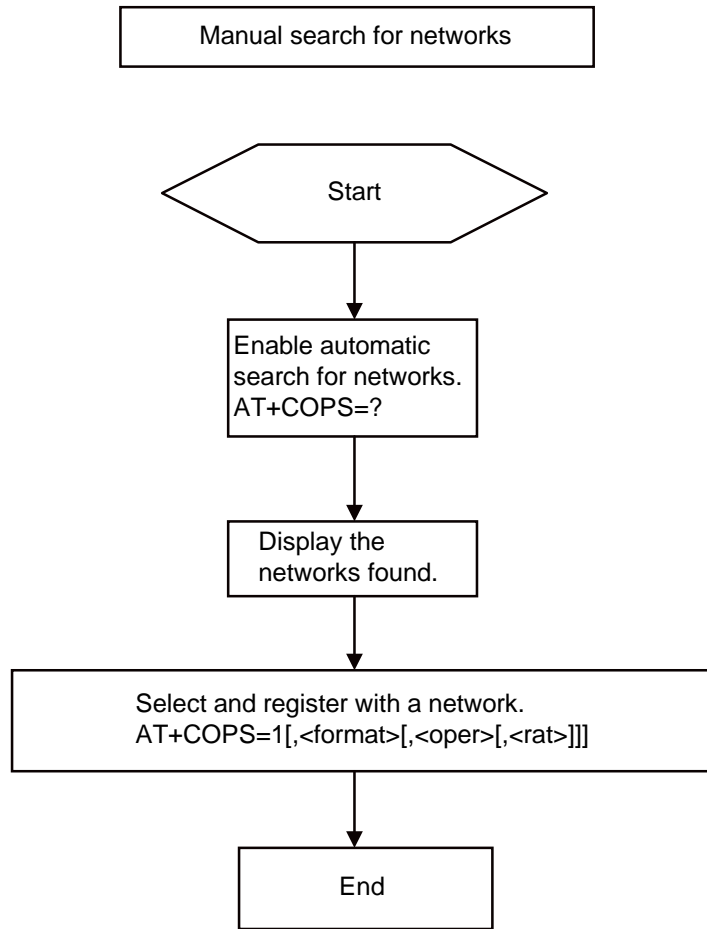

Figure 3-2 Manual search for networks



3.1.2 Troubleshooting

Scenario	Possible Error Information	Solution
AT+COPS?	+CME ERROR: SIM failure	No SIM card is detected. Insert a SIM card.
AT+CREG?	+CME ERROR: SIM failure	No SIM card is detected. Insert a SIM card.

4 ECM Application Scenarios

4.1 ECM Dialing

4.1.1 Reference Process

Command	Description
AT^NDISDUP=?	Check the parameter range supported by the command.
^NDISDUP: (1-16),(0-1)	
OK	
AT^NDISDUP=1,1,"1234"	Set up a dial-up connection using the APN provided by the network server.
OK	The command is successfully executed.
^NDISSTAT: 1,,,"IPV4"	Report the dial-up connection state.
AT^NDISDUP=1,1,"4321","huawei", "huawei",1	Set up a dial-up connection using the account, password, and authentication mode provided by the network server.
OK	The command is successfully executed.
^NDISSTAT: 1,,,"IPV4"	Report the dial-up connection state.

The process of obtaining the IP address:

1. After the dial-up is successful, the module will establish the DHCP service automatically.
2. The PC driver will get the dial-up state and send net_ready state to the network manage.
3. The network manage sends the DHCP service discover.

4. The module responses the service discover, and then sends the IP and DNS address which is obtained from the PDP active process to the network managing device.

4.1.2 Troubleshooting

Scenario	Possible Error Information	Solution
AT^NDISDUP=1,1,"1234"	+CME ERROR: SIM failure	No SIM card is detected. Insert a SIM card.
AT^NDISDUP=1,1,"4321", "huaei", "huawei", 1	OK ^NDISSTAT: 0,33,, "IPV4" ^NDISEND: 1,29	NDISEND indicates the failure reason during the dial-up. 29 indicates that the authenticated information is not correct.
AT^NDISDUP=1,1,"abcd"	OK ^NDISSTAT: 0,33,, "IPV4" ^NDISEND: 1,33	NDISEND indicates the failure reason during the dial-up. 33 indicates that request service is not specified. In this case, the network don not support this APN "abcd".

4.2 Querying the Dial-up Connection State

4.2.1 Reference Process

Command	Description
AT^NDISSTATQRY?	Query the dial-up connection state.
^NDISSTATQRY: 0,0,,IPV4	Report that the connection is not set up.
OK	
AT^NDISSTATQRY?	Query the dial-up connection state.
^NDISSTATQRY: 1,,IPV4	Report that the connection is set up.
OK	



4.2.2 Troubleshooting

None

4.3 Disconnecting the Dial-up Connection

4.3.1 Reference Process

Command	Description
AT^NDISDUP=1,0	Disconnect the dial-up connection.
OK	The command is successfully executed.
^NDISSTAT:0,,,"IPV4"	IPv4 changes from the connected state to the disconnected state.

4.3.2 Troubleshooting

None

5 SMS Application Scenarios

5.1 Overview

Short Message Service (SMS) is a text messaging service using a service center(SC) to transfer short text messages between GSM MEs and Short Message Entities (SMEs). ME909u-521 only supports protocol data unit (PDU) mode message.

A message must contain the following information before it is sent:

For a PDU mode message:

- Length of TPDU package
- Message content: To compose or send a PDU mode message, the message must contain all the message attributes and be encoded in PDU format. A PDU consists of the following:
 - Service Center Address (SCA): composed of the address length, SCA type and SCA reverse byte.
 - First octet: contains the message type indicator, TP-RP, TP-UDHI, TP-SRR, TP-VPF, TP-RD, and TP-MTI.
 - Short text message statement.
 - Destination address: consisting of the destination address, address length and destination address type.
 - Protocol identifier.
 - Data encoding scheme.
 - Validity duration.
 - Data length.
 - User data: consisting of the user data header and the data encoded in PDU format.

Figure 5-1 shows an example of data encoded in PDU format of submitted type.

Figure 5-1 Example of data encoded in PDU format of submitted type

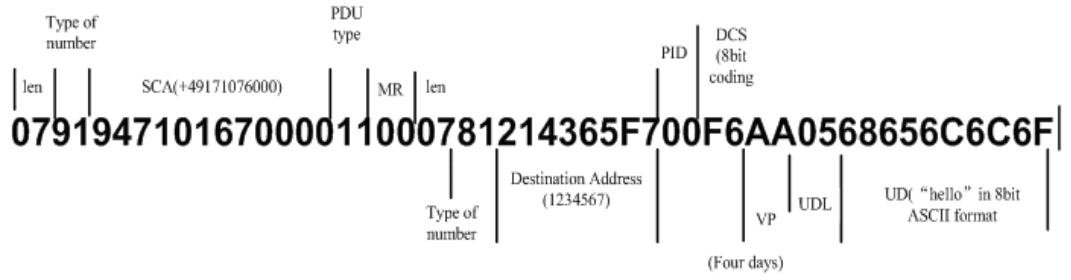
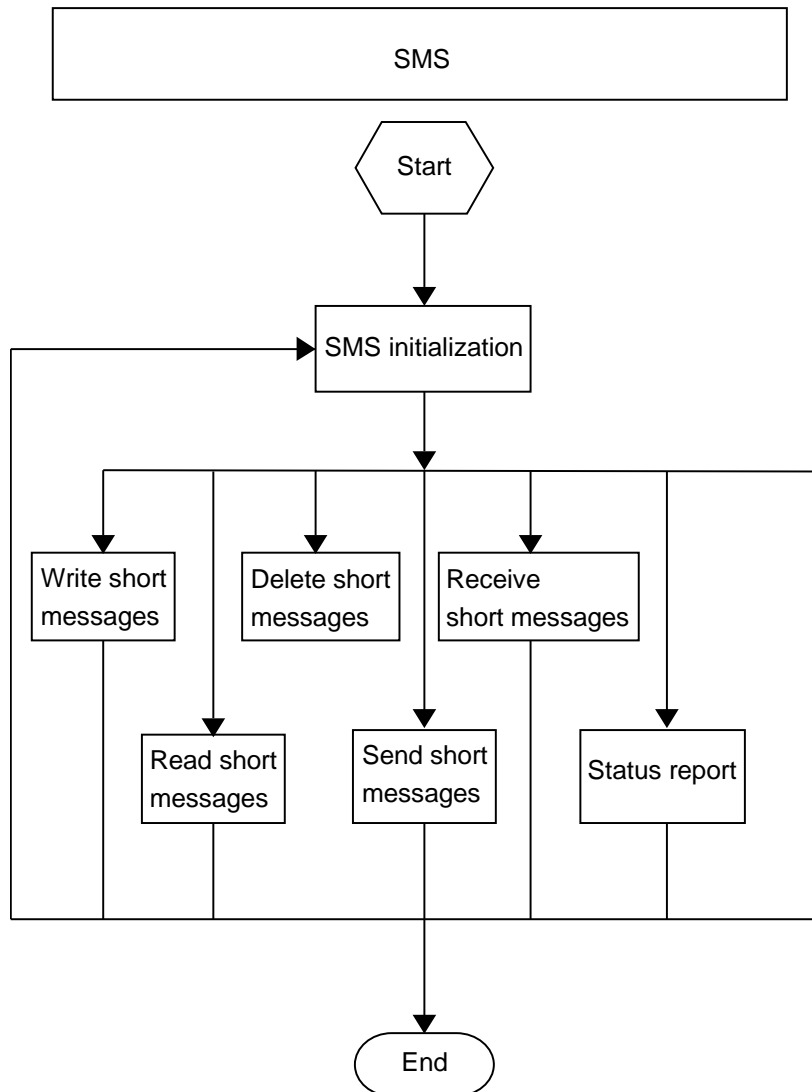

Figure 5-2 shows the general SMS process.

Figure 5-2 General SMS process



5.2 Initializing SMS

5.2.1 Reference Process

Command	Description
AT+CSCA?	Query the SMSC address.
+CSCA: "13800688509",129	
OK	
AT+CSCA="+8613800755500"	Set the SMSC address to the SMSC number of China Mobile's Shenzhen Branch.
OK	
AT+CSMS?	Query the short message service type.
+CSMS: 0,1,1,1	
OK	
AT+CNMI?	Query the configuration of the new message indications to TE.
+CNMI: 0,0,0,0,0	
OK	
AT+CNMI=2,1,2,2,0	Configure the new message indications to TE.
OK	
AT+CPMS?	Query the preferred short message storage.
+CPMS: "SM",12,20,"SM",12,20,"S M",12,20	
OK	
AT+CPMS="SM"	Set SM as short message storage medium.
OK	
AT+CGSMS?	Query the MO SMS bearer domain.
+CGSMS: 1	
OK	
AT+CMGF?	Query the short message format.
+CMGF: 0	

Command	Description
OK	
AT+CMGF=0	Set the short message format to PDU.
OK	

Use the **AT+CMGF** command to set short message format: **AT+CMGF=0** sets the short message format to PDU.

The SMSC address provided by the service provider must be specified. In PDU mode, the SMSC address is contained in the PDU packets. Therefore, in PDU mode, the **AT+CSCA** command is optional.

To use the SMS features specified in the GSM 07.05 Phase 2+, the **AT+CSMS** command must be used to enable the features.

Use the **AT+CNMI** command to set the unsolicited indications.

Use the **AT+CPMS** command to select the preferred short message storage (SIM or ME). The ME909u-521 supports only the SM (SIM card) storage.

Use the **AT+CGSMS** command to select the MO SMS bearer domain (PS or CS domain). For ME909u-521, the CS domain is the preferred MO bearer domain.

Figure 5-3 SMS initialization process – part 1

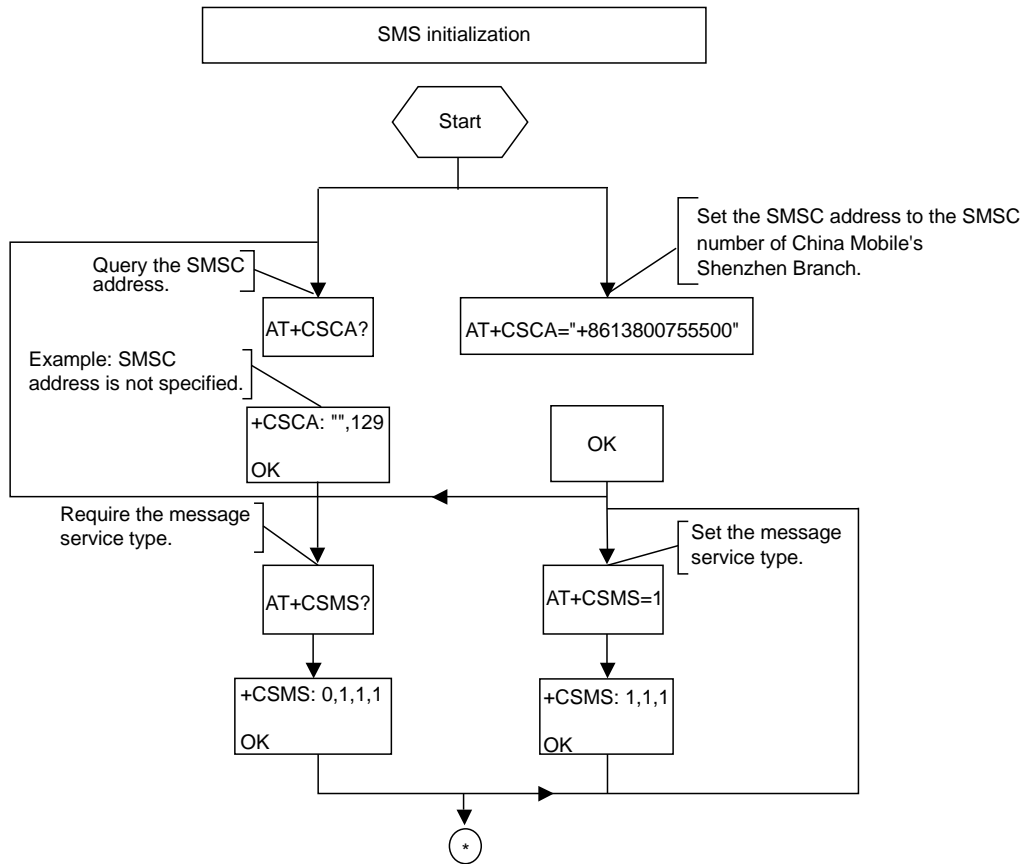

Figure 5-4 SMS initialization process – part 2

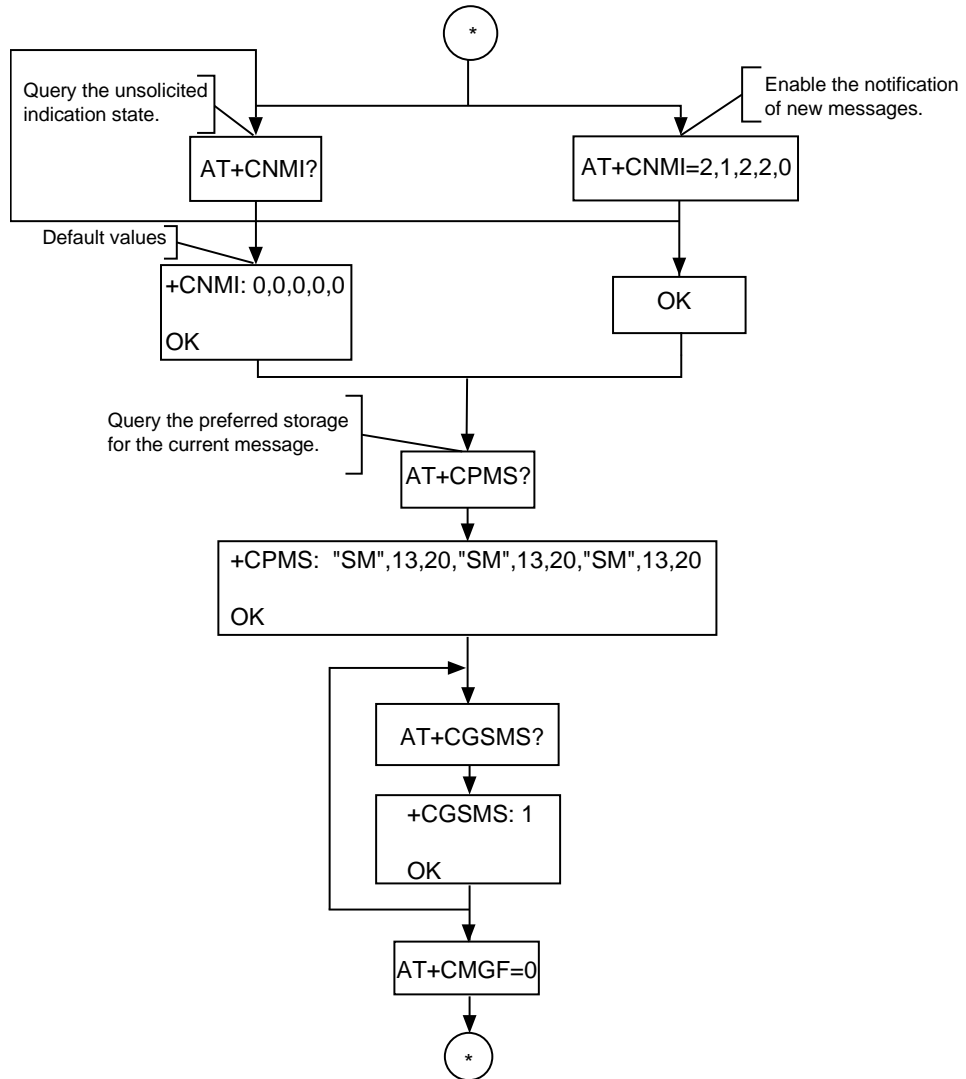
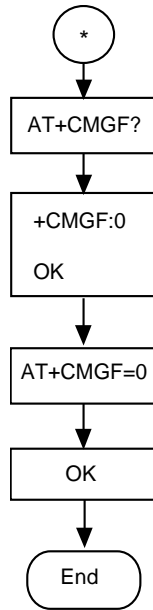

Figure 5-5 SMS initialization process – part 3



5.2.2 Troubleshooting

Scenario	Possible Error Information	Solution
Error information is returned in response to one of the previous commands.	+CME ERROR: SIM PIN required	Enter the correct PIN.
	+CMS ERROR: SIM busy	SIM card initialization has not completed. Try again later.

5.3 Sending Short Message

5.3.1 Reference Process

Command	Description
AT+CMGF=0 OK	Set the short message format to PDU.
AT+CSCA? +CSCA: "13800688509",129 OK	Query the SMSC address.
AT+CMGS=18	Send a PDU message without the service center

Command	Description
>0031000B813109731147F40000FF04F4F29C0E\x0A	address. The value of SMSC address is the setting of +CSCA command.
+CMGS: 168	The message is successfully sent.
OK	
AT+CMGS=18	Send a PDU message with the correct service center address.
>0891683108608805F931000B813109731147F40000FF04F4F29C0E\x1A	
+CMGS: 169	The message is successfully sent.
OK	
AT+CMGS=18	Send a PDU message with the wrong service center address.
>0891683108608805F031000B813109731147F40011FF04F4F29C0E\x1A	
+CMS ERROR: Network out of order	The message is unsuccessfully sent.

Messages in PDU format must be converted using external tools or users' software. Tools for encoding and parsing messages in PDU format are available on the Internet.

Figure 5-6 Sending short messages in PDU format

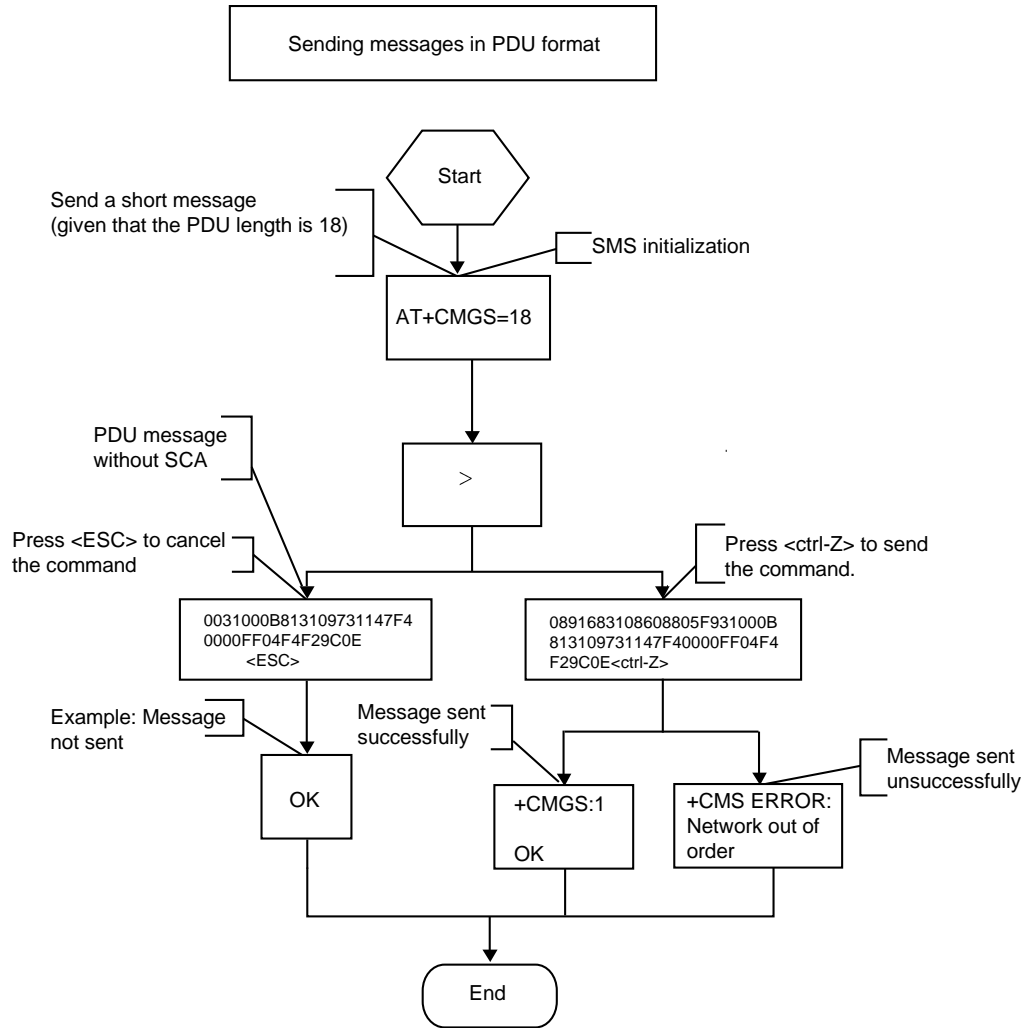

5.3.2 Troubleshooting

Scenario	Possible Error Information	Solution
Error information is returned in response to one of the previous commands.	+CMS ERROR: Network out of order	Check the validity of the service center address or the state of the current network.

5.4 Reading Short Messages

5.4.1 Reference Process

Command	Description
AT+CMGL=0	List all received unread messages.
+CMGL: 2,0,,48 0891683108608805F9040D916831 09732097F2000001432619001001 F506215744FD3D1A0E930C8429 6D9EC370BFDE86C2F23228FFA EFF00 +CMGL: 4,0,,64 0891683108608805F9040D916831 09732097F2000001403261310500 32506215744FD3D1A0E930C8429 6D9EC370BFDBE83C2B0380F6A 97416FF7B80C6AVFE5E510	The format of short messages can refer to the AT+CMGL command.
OK	
AT+CMGR=4	Read the message stored in the message storage location 4.
+CMGR: 1,,64 0891683108608805F9040D916831 09732097F2000001403261310500 32506215744FD3D1A0E930C8429 6D9EC370BFDBE83C2B0380F6A 97416FF7B80C6AVFE5E510	The format of short messages can refer to the AT+CMGR command.
OK	

There are two methods to read short messages:

- Method 1: Use the **AT+CMGL** command to list the messages that are in specified state and stored in the preferred message storage. The following table describes the message states. If the message state is received unread messages, the REC UNREAD state will be changed to REC READ after the **AT+CMGL** command is executed.

Message State	PDU Mode
Received unread messages	0
Received read messages	1
Stored unsent messages	2
Stored sent messages	3

Message State	PDU Mode
All messages	4

- Method 2: Use the **AT+CMGR** command to read a message from a specified storage location in the message storage. If the message is a received unread message, its state will be changed to REC READ after it is read using the **AT+CMGR** command.

You can use the **AT+CMGL** command to list all short messages so that you can view the messages' storage locations.

Figure 5-7 Reading short messages

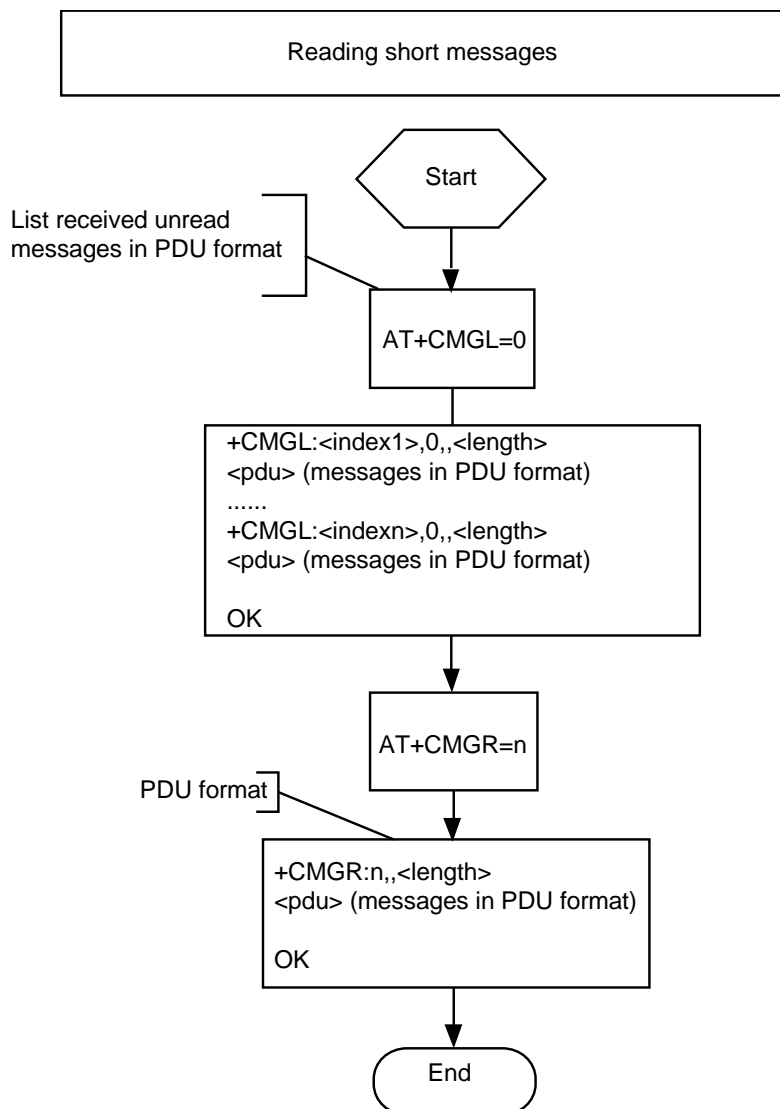

5.4.2 Troubleshooting

Scenario	Possible Error Information	Solution
Error information is returned in response to one of the previous commands.	+CMS ERROR: invalid memory index	Check the validity of the index.

5.5 Deleting Short Messages

5.5.1 Reference Process

Command	Description
AT+CMGF=0	Set the message format to PDU mode.
OK	
AT+CMGL=4	List all short messages (PDU mode).
+CMGL: 6,2,,30 0011000A917179876213000 0A713C8329BFD6681D0EF 3B282C2F83F2EFFA0F	
+CMGL: 11,1,,36 0791947106004013240C919 47159826990000030804131 15748013C8329BFD6681D0 EF3B282C2F83F2EFFA0F	
OK	
AT+CMGD=1	Delete the message stored in storage location 1.
OK	

- Either all messages stored in the preferred message storage or a message stored in the specified storage location in the preferred message storage can be deleted.
- All read or unread messages that have been received can be deleted.
- If no messages are stored in the preferred message storage, "OK" is returned when the action to delete messages is completed.
- Meanings of the DelFlag value:
 - 1: Delete all read messages in the preferred message storage, and keep the unread, sent and unsent messages.

- 2: Delete all read and sent messages in the preferred message storage, and keep the unread and unsent messages.
- 3: Delete all read, sent, and unsent messages in the preferred message storage, and keep the unread messages.
- 4: Delete all messages in the preferred message storage, including the unread messages.

Figure 5-8 Deleting short message

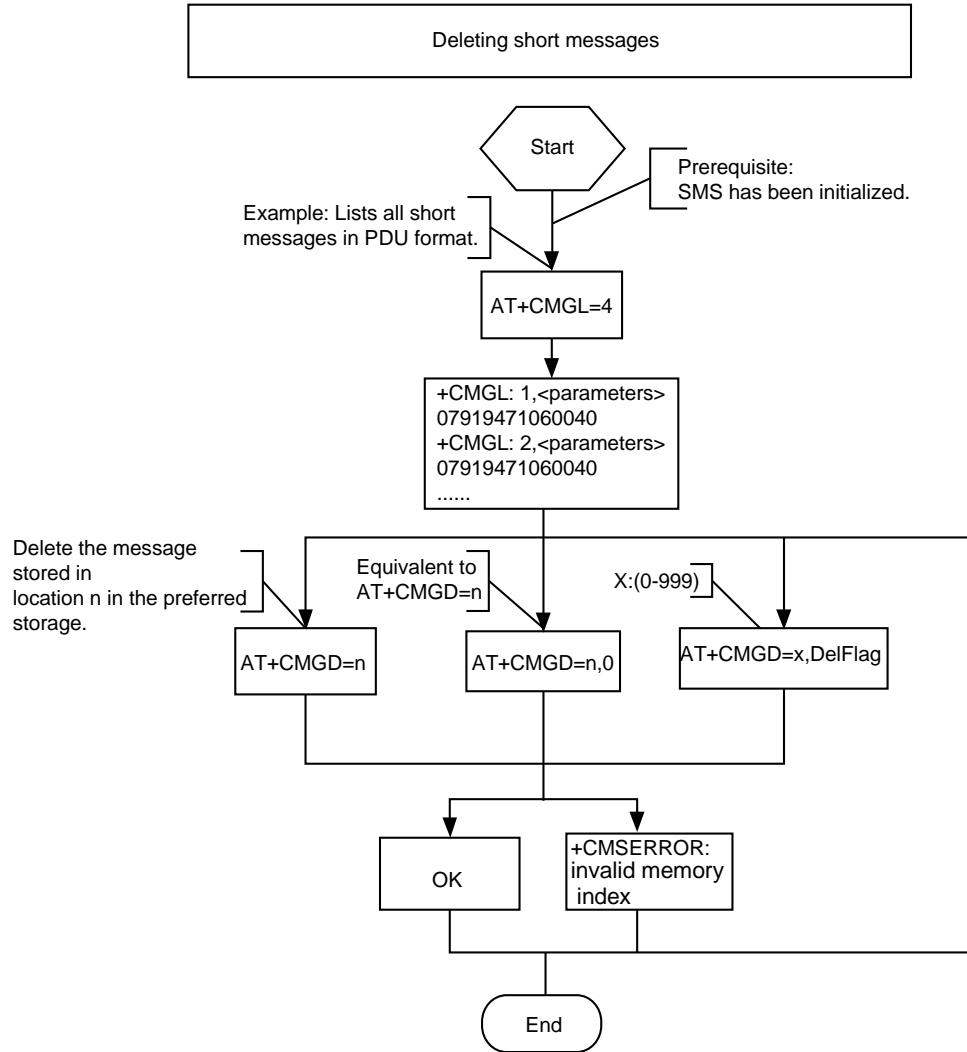

5.5.2 Troubleshooting

Scenario	Possible Error Information	Solution
Error information is returned in response to one of the previous commands.	+CMS ERROR: invalid memory index	Check the validity of the index.

6 Phonebook Application Scenarios

6.1 Overview

As a product embedded into a host, the phonebook scenarios include that read, write, query and delete the phonebook entries in the SIM card.

Read Phonebook: use the **AT+CPBR** command to read phonebook entries.

Write phonebook: use the **AT+CPBW** command to save the phonebook entries into the SIM card.

Delete phonebook: use **AT+CPBW** command to delete the phonebook entries in the SIM card.

6.2 Memory Operations

6.2.1 Reference Process

Command	Description
AT+CPBS=? +CPBS: ("SM","EN","ON") OK	Query the current storage type.
AT+CPBS="SM" OK	Set the current storage type to "SM".
AT+CPBS? +CPBS: "SM",241,250 OK	241 indicates that 241 entries have been stored in the storage. 250 indicates that the maximum storage capacity of the current storage ("SM") is 250 entries.

Note that the AT commands for reading and writing phonebook entries can be used only after the phonebook storage is selected. To select a phonebook storage, use the **AT+CPBS** command.

Figure 6-1 Initializing the phonebook

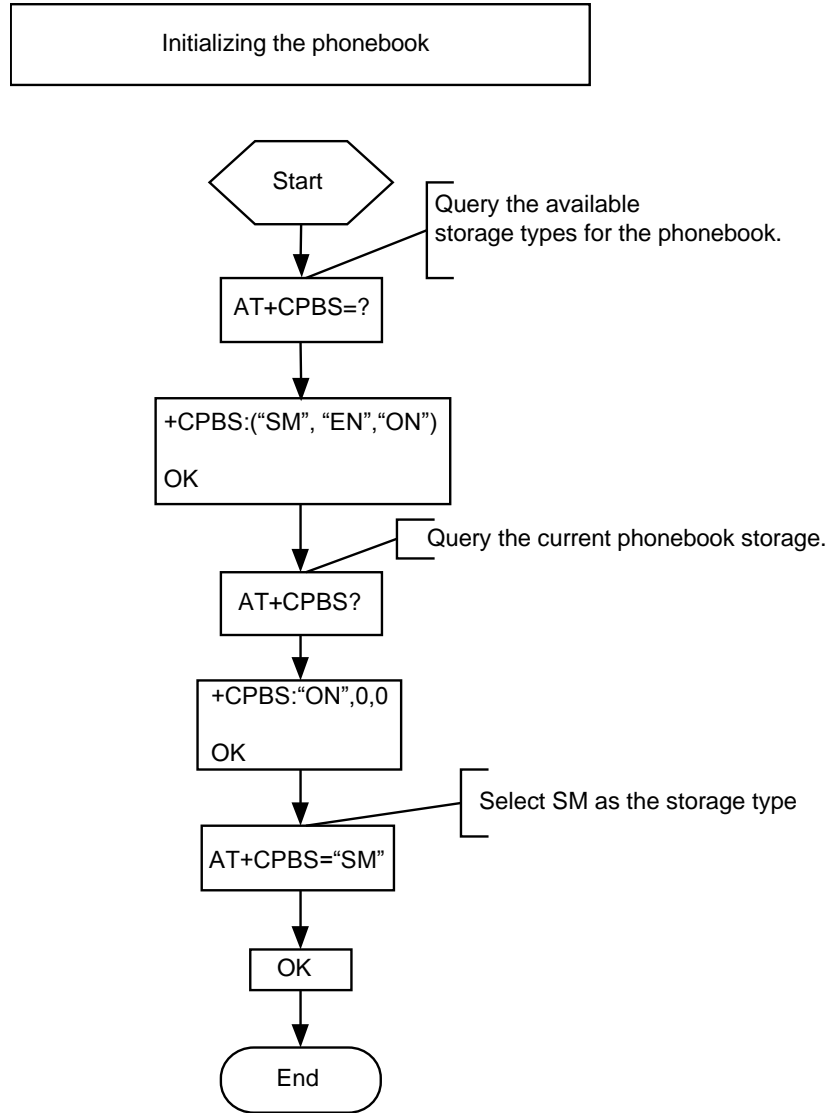

6.2.2 Troubleshooting

Scenario	Possible Error Information	Solution
Error information is returned in response to one of the previous commands.	+CME ERROR: SIM busy	Phonebook initialization has not completed. Try again later.
	+CME ERROR: SIM PIN required	Enter the correct PIN.

Scenario	Possible Error Information	Solution
	+CME ERROR: SIM PUK required	Enter the correct PUK.

6.3 Reading Phonebook Entries

6.3.1 Reference Process

Command	Description
AT+CPBS? +CPBS: "SM",9,20 OK	Query the phonebook storage selection and the maximum number of entries that can be stored.
AT+CPBR=1,20 +CPBR: 1,"+491765864491",145,"John Smith" +CPBR: 2,"+44545896638",145,"Paul Williams" +CPBR: 3,"+44556565657",145,"Joe Anderson" +CPBR: 4,"+445636934485",145,"Oscar Thomso" +CPBR: 5,"+445565656899",145,"Hannah Adams" +CPBR: 6,"+447982865563",145,"Samantha Young" +CPBR: 7,"+449585315798",145,"Alexis Wright" +CPBR: 8,"+445415454646",145,"Abigail Cox" +CPBR: 12,"+446565689115",145,"Kyla Clark"	List all phonebook entries by their indexes.

Command	Description
OK	

Figure 6-2 Reading phonebook entries

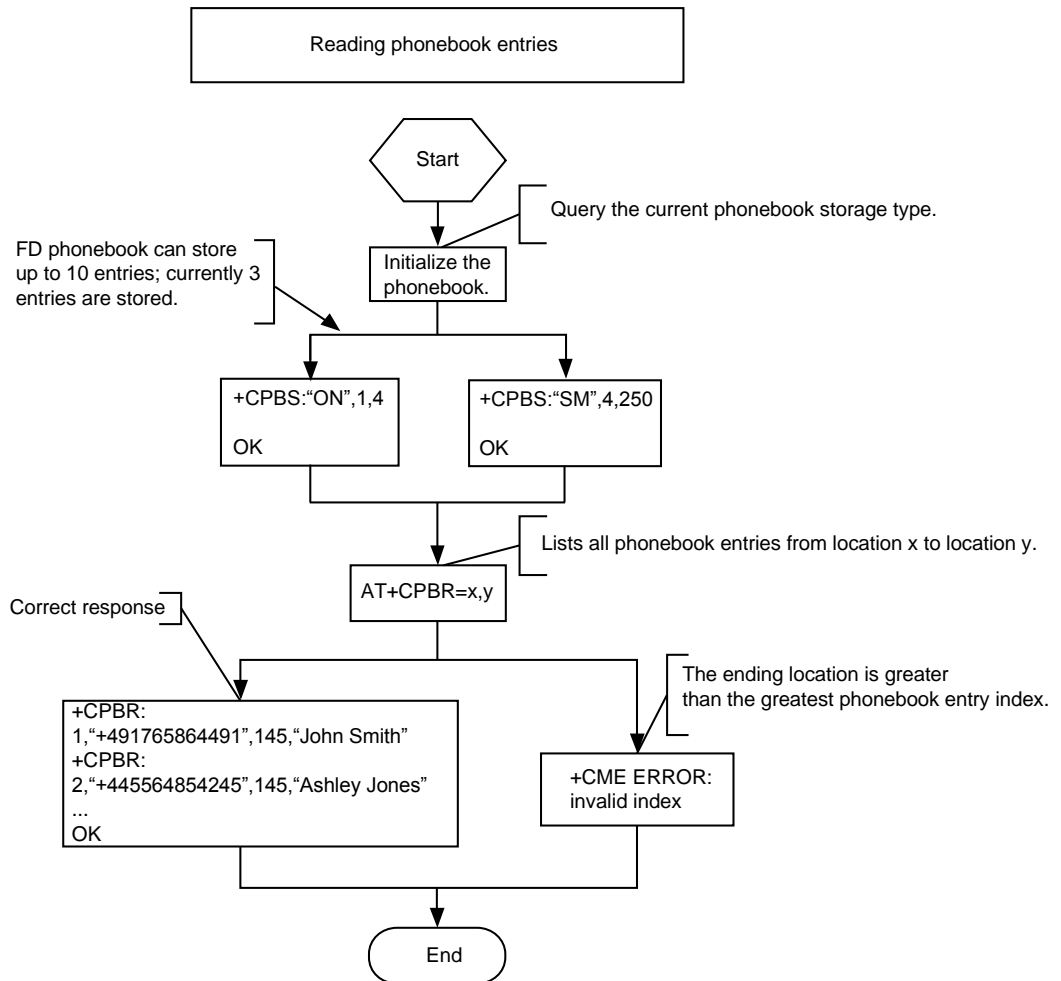

6.3.2 Troubleshooting

Scenario	Possible Error Information	Solution
Error information is returned in response to one of the previous commands.	+CME ERROR: SIM busy	Phonebook initialization has not completed. Try again later.
	+CME ERROR: SIM PIN required	Enter the correct PIN.
	+CME ERROR: SIM PUK required	Enter the correct PUK.

Scenario	Possible Error Information	Solution
AT+CPBR=<index1>	+CME ERROR: invalid index	The index is invalid. Check that index 1 is within the supported range.
AT+CPBR=<index1>, <index2>	+CME ERROR: invalid index	The index is invalid. Check that index 1 and index 2 are within the supported range and that index 1 is not greater than index 2.
AT+CPBR=<index1>	+CME ERROR: not found	No entries are found in the storage locations in index 1. Check that there have been entries successfully written into these locations.
AT+CPBR=<index1>, <index2>	+CME ERROR: not found	No entries are found in the storage locations between index 1 and index 2. Check that there have been entries successfully written into these locations.

6.3.3 Writing/Deleting Phonebook Entries

6.3.4 Reference Process

Command	Description
AT+CPBR=?	Query the ranges of parameters related to the phonebook entries.
+CPBR: (1-250),24,14	
OK	
AT+CPBW="5","13903702 805",,"test"	Write a phonebook record.
OK	
AT+CPBW=1	Delete the entry in index 1 in the phonebook.
OK	

There are two methods to edit phonebook entries using the **AT+CPBW** command:

- Write an entry to a specified location. This method edits the location where a phonebook entry exists or writes a new entry to a vacant location.

- Write a new phonebook entry to the next location of a location that already has a phonebook entry. This method does not require a specified storage location. The **AT+CPBW** command can be used to edit phonebook entries of the "SM" or "ON" type.

Figure 6-3 Writing phonebook entries

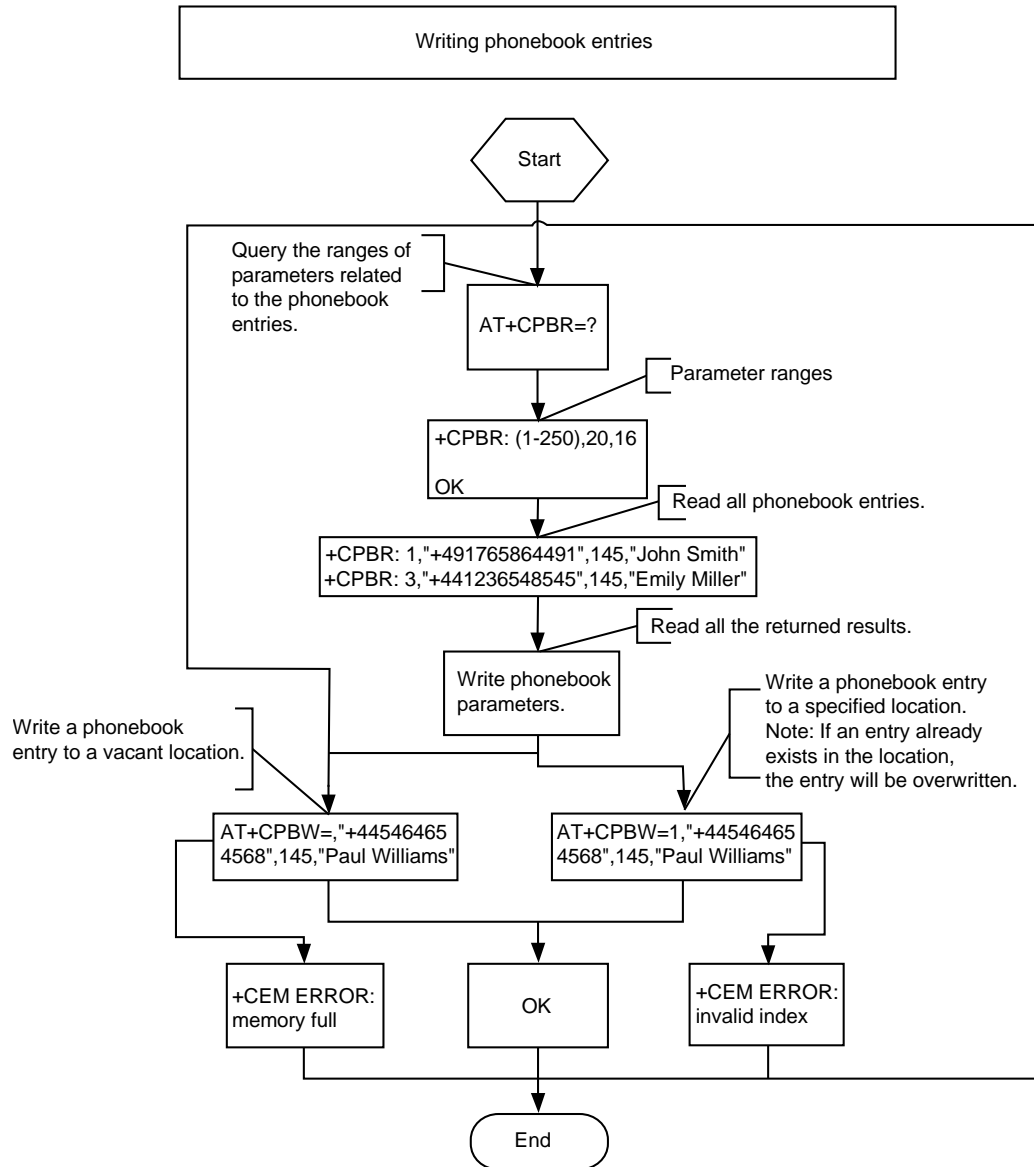

6.3.5 Troubleshooting

Scenario	Possible Error Information	Solution
Error information is returned in response to one of the previous	+CME ERROR: SIM busy	Phonebook initialization has not completed. Try again later.

Scenario	Possible Error Information	Solution
commands.	+CME ERROR: SIM PIN required	Enter the correct PIN.
	+CME ERROR: SIM PUK required	Enter the correct PUK.
Error information is returned when writing an entry into the phonebook.	+CME ERROR: dial string too long	Check that the phone number is not too long.
Error information is returned in response to one of the previous commands.	+CME ERROR: invalid index	Check that the location index and phone number type are valid.
Error information is returned when writing an entry into the phonebook.	+CME ERROR: invalid characters in dial string	The phone number to be written into the phonebook contains invalid characters. Delete the invalid characters and try again.
AT+CPBW=,"12345678901234567890123",128,"80534E4E3A"	+CME ERROR: memory full	The storage is full. Delete some entries and try again.

6.4 Searching for Phonebook Entries

6.4.1 Reference Process

Command	Description
AT+CPBF=<findtext>	Search the current storage for phonebook entries that contain the <findtext> field.
+CBPF: <index1>,<number>,<type>,<text>	
+CBPF: <index2>,<number>,<type>,<text>	
...	
OK	
AT+CPBF=?	Return the maximum phone number length and maximum name length supported by the current phonebook storage.
+CPBF: <nlength>,<tlength>	

OK

6.4.2 Troubleshooting

Scenario	Possible Error Information	Solution
Error information is returned in response to one of the previous commands.	+CME ERROR: SIM busy	Phonebook initialization has not completed. Try again later.
	+CME ERROR: SIM PIN required	Enter the correct PIN.
	+CME ERROR: SIM PUK required	Enter the correct PUK.
AT+CPBF=<findtext>	+CME ERROR: not found	No matches were found. Check whether the current phonebook storage has entries that match the search criterion.

6.5 Querying User Number

6.5.1 Reference Process

Command	Description
AT+CNUM	Query the SIM number.
+CNUM: [<alpha1>],<number1>,<type1>	
+CNUM: [<alpha2>],<number2>,<type2>	
...	
OK	

6.5.2 Troubleshooting

Scenario	Possible Error Information	Solution
Error information is returned in response to one of the previous commands.	+CME ERROR: SIM busy	Phonebook initialization has not completed. Try again later.
	+CME ERROR: SIM PIN required	Enter the correct PIN.
	+CME ERROR: SIM PUK required	Enter the correct PUK.

6.6 Setting the TE's Character Sets

6.6.1 Reference Process

Command	Description
AT+CSCS=?	Query the character sets supported by the UE.
+CSCS: ("IRA","GSM","UCS2")	
OK	
AT+CSCS?	Query the current character set.
+CSCS: "IRA"	
OK	
AT+CPBR=1	Read the first phonebook entry. The TE character set is the International Reference Alphabet (IRA). The content of the first entry's name field is "HUAWEI".
+CPBR: 1,"0123456789",129,"HUAWEI"	
OK	
AT+CSCS="UCS2"	Set the TE's character set to UCS alphabet.
OK	
AT+CPBW=1,"0123456789",129,"004800550041005700450049"	The character set is the UCS alphabet. The content of the phonebook entry's



name field is
004800550041005700450049, which is
"HUAWEI" in the IRA.

OK

AT+CPBR=1

Read the first phonebook entry. The TE
character set is UCS alphabet. The
content of the first entry's name field is
004800550041005700450049 ("HUAWEI"
in the IRA).

+CPBR:
1,"0123456789",129,"004800550041
005700450049"

OK

6.6.2 Troubleshooting

None

7 SIM Operation Application Scenarios

7.1 PIN Operations

7.1.1 Reference Process

Command	Description
AT+CLCK="SC",1,"<pwd>"	Enable PIN authentication. (<pwd> specifies the PIN. See note 1.)
OK	
AT+CLCK="SC",2	Request the SIM card state.
+CLCK: 1	"+CLCK: 1" means that the SIM card is not blocked.
OK	
AT+CLCK="SC",0," <pwd>"	Disable the SIM card lock. (<pwd> specifies the PIN. See note 1.)
OK	
AT+CLCK="SC",2	Request the SIM card state.
+CLCK: 0	"+CLCK: 0" means that the SIM card is not blocked.
OK	
AT+CLCK="SC",1,"<pwd>"	Enable PIN authentication. (<pwd> specifies the PIN. See note 1.)
OK	
AT+CPIN="<pwd>"	Request the PIN after the module restarts.
OK	
AT+CPIN?	Request the PIN state.
+CPIN: READY	

OK

AT+CLCK="SC",2

Request the SIM card state.

+CLCK: 1

"+CLCK: 1" means that the SIM card is not blocked.

OK

AT+CPWD="SC", "<oldpwd>", "1234"

Change the PIN (1234 will be the new PIN).

OK

AT+CPWD="SC", "1113", "1233"

Enter an incorrect PIN (first attempt).

+CME ERROR: incorrect password

AT+CPWD="SC", "3333", "1233"

Enter an incorrect PIN (second attempt).

+CME ERROR: incorrect password

AT+CPWD="SC", "4711", "1233"

Enter an incorrect PIN (third attempt).

+CME ERROR: SIM PUK required

AT+CPIN?

Check whether the password is requested.

+CPIN: SIM PUK

OK

AT+CPIN="12345678", "0000"

Enter the SIM PUK and specify the new SIM PIN (activate new "SC" lock).

OK

Notes:

- After PIN authentication is enabled using **+CLCK**, the module must be restarted for the change to take effect.
- Either **^CPIN** or **+CPIN** can be used to authenticate the PIN.

7.1.2 Troubleshooting

Scenario	Possible Error Information	Solution
Enable PIN authentication. AT+CLCK="SC",1,"<pwd>"	+CME ERROR: operation not allowed	If PIN authentication has been enabled, it cannot be enabled again. Check whether PIN authentication has been enabled.

Scenario	Possible Error Information	Solution
Enter the PIN. AT+CPIN="<pwd>"	+CME ERROR: incorrect password	Enter the correct PIN. The original PIN is provided by the operator.
	+CME ERROR: SIM PUK required	Incorrect PINs have been entered three times and the SIM card is blocked. Run AT+CPIN="<PUK>","<pwd>" to enter the PUK to unblock the SIM card. The PUK is provided by the operator and cannot be changed by users. If incorrect PUKs are entered 10 times, the SIM card will be permanently blocked.
Changes the PIN. AT+CPWD="SC","<oldpwd>","<newpwd>"	+CME ERROR: incorrect password	<oldpwd> must be the current PIN. Like the PIN authentication, if incorrect PINs are entered three times, the PUK will be required. If incorrect PUKs are entered 10 times, the SIM card will be permanently blocked.

7.2 CRSM Command

7.2.1 Reference Process

Command	Description
AT+CRSM=176,12258,0,0,10	Read the file EFiccid with a transparent structure. (12258 is 0X2FE2, the EFiccid file's FID).
+CRSM: 144,0,"<record>"	After the command is processed successfully, the EFiccid file's content (<record>) is returned.
OK	
AT+CRSM=178,28476,1,4,176,,,"7F10"	Use an absolute path to read the first entry from the EFsms file on the SIM card's DFtelecom folder.
+CRSM: 144,0,"<record>"	<record> is the content of the first entry. The length of <record> is 176 bytes.
OK	
AT+CRSM=192,12258	Get response of EFiccid.

+CRSM: 144,0,"<response>"	<response> is the response data of EFiccid. For details about <response>, refer to the <i>ETSI TS 102.221</i> protocol.
OK	
AT+CRSM=214,28421,0,0,2,"0012"	Update the content of the transparent structure EFi file on the SIM card.
+CRSM: 144,0,""	Update succeeded.
OK	
AT+CRSM=220,28476,1,4,176,"1111", "7F10"	Update the content of the linear fixed structure EFsms file on the SIM card.
+CRSM: 144,0,""	Update succeeded.
OK	
AT+CRSM=242	Obtain the current directory information.
+CRSM: 108,"<length>","<status>"	<length> indicates <status>'s length in byte.
OK	<status> indicates the current directory status by hexadecimal.

Notes:

- To read or update a file, appropriate commands must be used according to the file's structure type (for details, refer to the description of file properties in the *3GPP TS 31.102* protocol). For transparent structure files, use 176 (Read Binary) and 214 (Update Binary). For linear fixed structure files, use 178 (Read Record) and 220 (Update Record).
- If <pathid> is not contained in the command, the module will prefer to access the files with the same FID in the current directory.
- Files can be accessed only when the access criteria are met. Otherwise the SIM card will return PSWs indicating that the access authentication failed. If an EF file's read privilege is PIN protected and the module does not have the PIN authenticated, PSWs indicating that the access authentication failed will be returned after the **+CRSM** command is used to read the EF file.
- To use the **+CRSM** command to access the file content on the SIM card, the parameters contained in the command must strictly meet the requirements in the *ETSI TS 10.2221* and *3GPP TS 31.102*. For detailed requirements, refer to the *ETSI TS 102.221* and *3GPP TS 31.102*.



7.2.2 Troubleshooting

Scenario	Possible Error Information	Solution
Update the content of the linear fixed structure EFsms file on the SIM card. AT+CRSM=178,12258,0,0,10	+CRSM: 105,129,"" OK	The status word (SW) indicates a Read command error occurred. Files with a transparent structure should be read using 176 (READ BINARY).
Update the content of the linear fixed structure EFsms file on the SIM card. AT+CRSM=220,28476,1,4,176,"1111","7F10"	+CRSM: 105,130,"" OK	The PSW indicates that the security conditions were not met. To update the EFsms file, the correct PIN is required.

8 Sleeping and Waking Up Application Scenarios

As an embedded component in the host, the module also consumes power, which increases the power consumption of the integrated product. Therefore, the most important task of power management is to reduce the power consumption of the integrated product by enabling the module's sleep mode when necessary.

The host and the module need to wake each other up from sleep if communication is required. Therefore, another task of power management is to provide a wake-up control mechanism for the host and module.

Power management involves three parts: the host system software (including the USB driver/UART driver/GPIO driver/sleep mechanism functions), connection hardware between the host and module, and the module's software wake-up mechanism.

This chapter is mainly concerned with the module's software wakeup mechanism, including the wake-up principle, how USB related events impact on the waking up of the module and remotely waking up the module, and how the module remotely wakes up the host.

This chapter briefly describes the power management related connection hardware between the host and module.

This chapter does not describe the host system software. For example, if the host runs on a Windows or Mac system, Huawei will provide a USB driver program corresponding to the module. If the host runs on an Android system, Huawei will provide [HUAWEI Module Android RIL Integration Guide](#) for users to configure the USB-based wakeup function of the module. If the host runs on a Linux system, power management is supported only when the Linux Kernel version is 2.6.35 or later.

This document describes typical module application scenarios. A host can be designed based on the actual system features and the application scenarios of the module to reduce power consumption of both the module and integrated product.

After the host is designed as recommended by this document, the module's power consumption and the whole unit's power consumption can meet the performance requirements. For details, see related description in the product manual.

8.1 Hardware Interfaces

The module communicates with the host using mainly USB or UART. For details about pins related to power management, see Table 8-1 .

For corresponding interface numbers and reference design for the pins, see *Hardware Guide* for each product.

Table 8-1 Power management related pins

Interface	Pin name	Direction	Functional Description	Diagram
PCIE	WAKE#	Output	When a wake-up source arrives, this pin output a low-level-voltage pulse lasting for 1s during which if other wake-up sources arrive, the module will ignore the later wake-up requests. In other words, the module will not output a second pulse during this 1s.	Figure 8-1
LGA	WAKEUP_OUT	Output	When a wake-up source arrives, this pin output a high-level-voltage pulse lasting for 1s during which if other wake-up sources arrive, the module will ignore the later wake-up requests. In other words, the module will not output a second pulse during this 1s.	Figure 8-2
LGA	WAKEUP_IN	Input	When the pin carries a high-level voltage, the states of the module are as follows: The module will be prohibited to enter sleep mode if the module is awake. The module will be woken up if the module is in sleep mode. When the pin carries a low-level voltage, the module is allowed to enter sleep mode. (By default, the pin is set to INPUT/PD, which is, the software detects a low-level voltage on the pin when the pin is not connected.)	Figure 8-3
LGA	SLEEP_STATUS	Output	Indicate the state of the module. When the pin carries a high-level voltage, the module is in working mode. When the pin carries a low-level voltage, the module is in sleep mode.	Figure 8-4

Note:

The PCIE interface does not support UART.

8.2 Sequence Diagram

Figure 8-1 WAKE# PIN output sequence

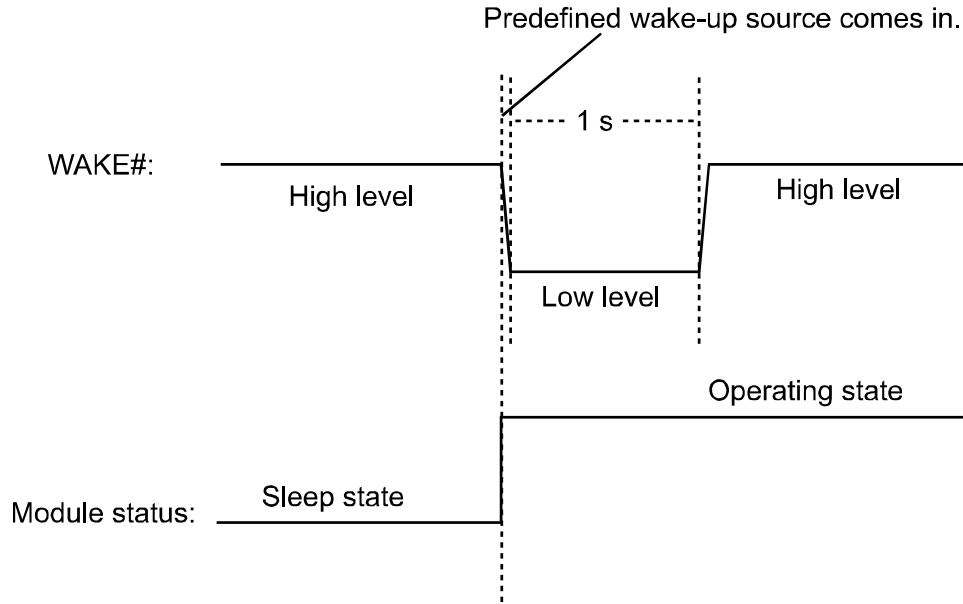

Figure 8-2 WAKEUP_OUT PIN output sequence

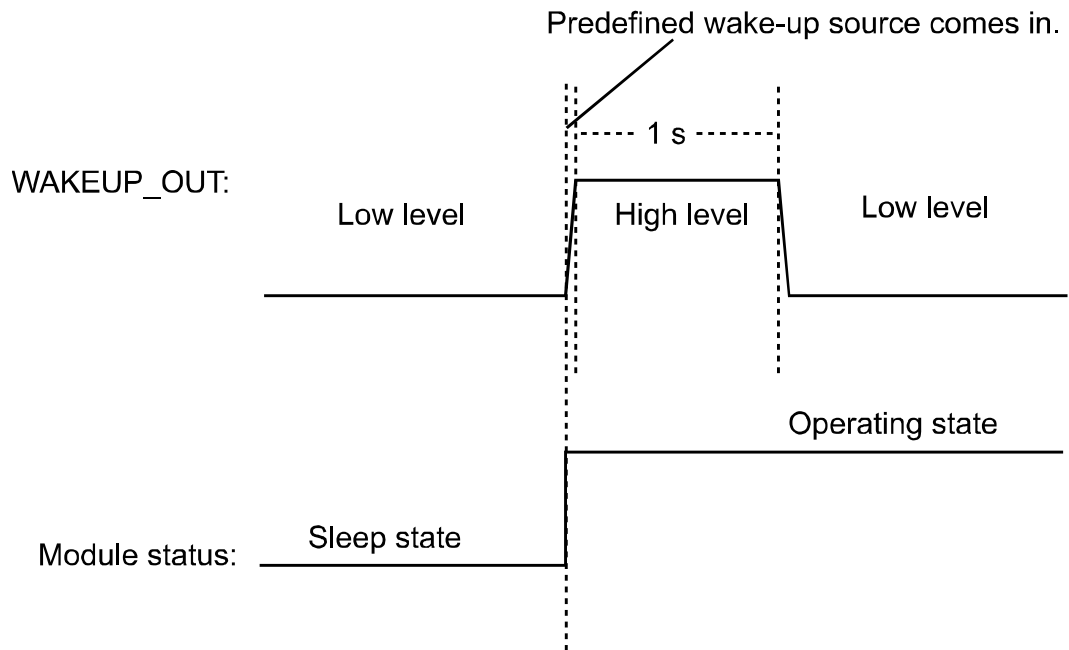
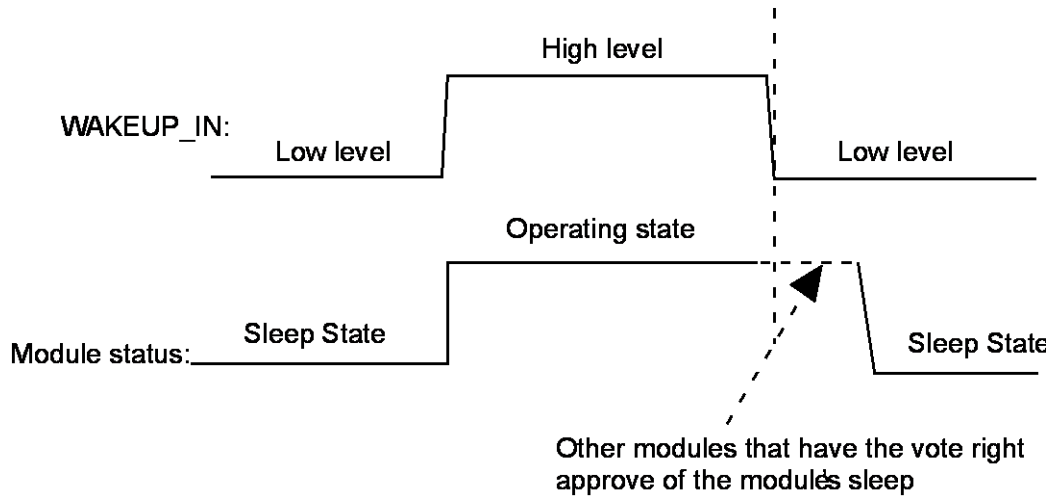
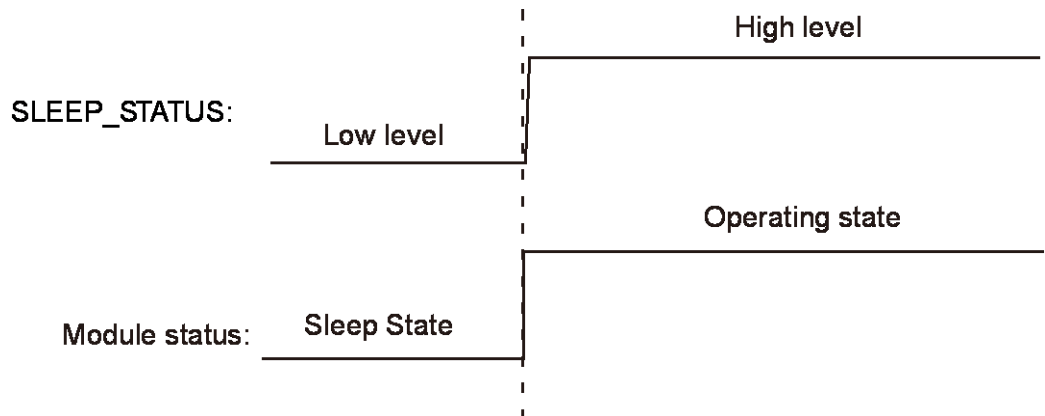

Figure 8-3 WAKEUP_IN PIN input sequence



About the vote, see section 8.3.1 .

Figure 8-4 SLEEP_STATUS PIN output sequence



8.3 Software Interfaces

8.3.1 Principle

The module runs on a multi-task software system. The sleep task is granted with the lowest priority and assigned to detect whether the module can enter sleep mode. Other tasks (such as the RF, SIM card, USB) have voting rights. They vote to decide whether the module can enter sleep mode. When no other tasks are running, the sleep task is executed. If the sleep task detects that all other tasks agree on the module's sleep, the module enters sleep mode, as shown in Figure 8-5 . At this time, the baseband chip reduces the work frequency, and the RF enters the Discontinuous Reception (DRX) mode.

Figure 8-5 Currency state when the module is in sleep mode

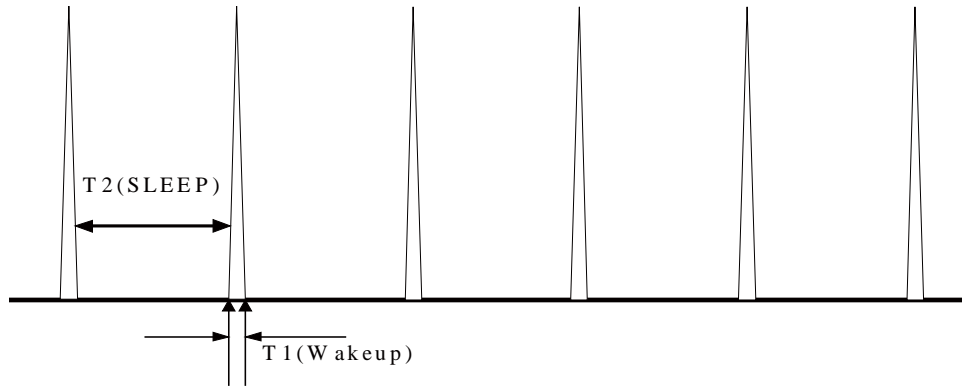

For more information about the module's sleep procedure, see Figure 8-6

Note:

The module's sleep mode is different from working mode or flight mode set using the **AT+CFUN** command. The RF will be turned off when the module enters LPM mode using the command **AT+CFUN=0** while the RF will enter DRX mode without being turned off when the module is in sleep mode. For more details, refer to [HUAWEI ME909u-521 LTE LGA Module AT Command Interface Specification](#).

The module enters sleep mode automatically when the sleep task detects that all other tasks agree on the module's sleep. The sleep period of the module depends on the current working state and circumstance. The period may last for several seconds, or up to several minutes.

Figure 8-6 Sleep procedure

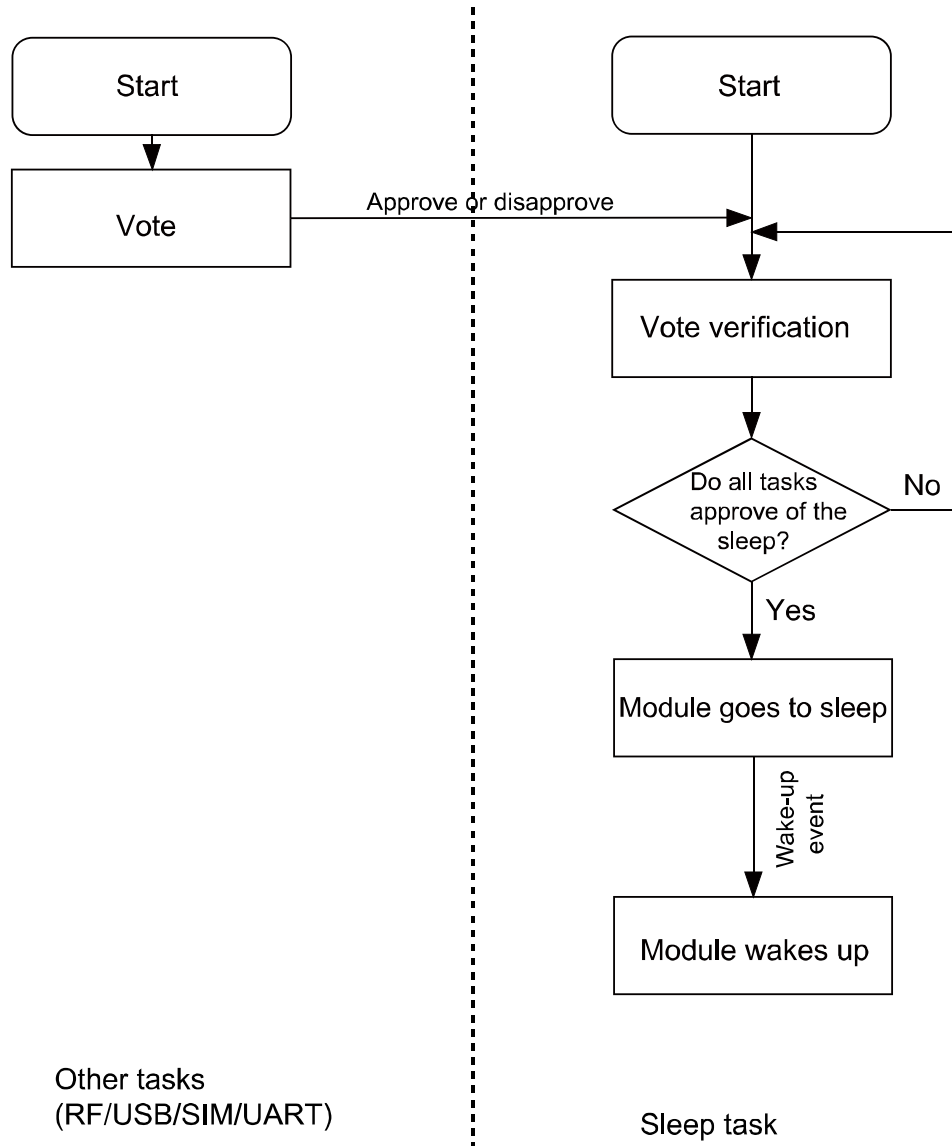

8.3.2 USB and Sleep

USB is an important communication channel between the module and the host. According to the USB protocol, normally a hub or a root hub periodically sends Start of Frame (SOF) data packages (one data package per ms using full-speed USB and one package per 125 μs using high-speed USB). Through this mechanism, USB always votes to stop the module from entering sleep mode.

When the USB driver provided by Huawei detects that the module and the host have not exchanged data in 5 seconds, the USB driver will enable the port's suspend feature, stopping SOF data packages being sent and suspending the USB controller. This enables the USB to vote to agree the module's sleep.

Note:

If the USB driver used is developed by users or is integrated with external application, ensure that the USB driver supports the USB suspend features (including selective suspend and global suspend, as defined in the USB standard.)

8.3.3 UART and Sleep

UART is an important communication channel between the module and the host. If the host uses UART (a TTL level Interface), it can connect to the module's UART directly. If the host uses RS232, it can connect to the module's UART through a conversion chip such as MAX232.

Note:

If the module is in sleep state, the host send data to module only by UART that can't wakeup the module. It must be used with WAKEUP_IN pin.

8.3.4 Module Wake-up

RF periodically wakes up the module based on the DRX cycle (depending on the actual configuration of the network system), as shown in Figure 8-5 .

Other aperiodic events include:

1. The host sends data using USB or pulls WAKEUP_IN up.
2. Changes on the network, for example, an incoming call, an incoming text message, a signal change, a network working mode change, a network search, an IP data package (when a dial-up network connection is set up).
3. Software system events such as a timer
4. Abnormal events, for example, an antenna drops or a SIM card becomes loose.

8.3.5 Host Woken up by Module

Wake-up Source

A wake-up source is a module event that can wake up the host, for example, an incoming voice call, a text message, data (PPP data, TCP/UDP data from the network), and unsolicited messages.

Remotely Waking up the Host Using USB

When the host is in sleep mode and the USB controller is in suspended mode, if the module needs to send data to the host (for example, a wake-up source has arrived), the module sends a remote wake-up signal that lasts 3 ms to inform the host to start USB resume (as shown in Figure 8-7). To complete the procedure, the following conditions must be met:

1. The USB controller on the host supports USB remote wake-up and can wake up the host.

2. The USB driver enables or disables remote wake-up by executing SET_FEATURE and CLEAR_FEATURE commands. Therefore, remote wake-up must be enabled on the USB driver before USB enters suspended mode.
3. When the host receives the remote wake-up signal from the module, the host needs to send a full speed K signal that lasts at least 20 ms. When the USB controller resumes, the host must send the SOF token within 3 ms from the startup of the idle state. Otherwise, the module enters suspended mode again, as shown in Figure 8-7 .

Figure 8-7 USB resume time sequence

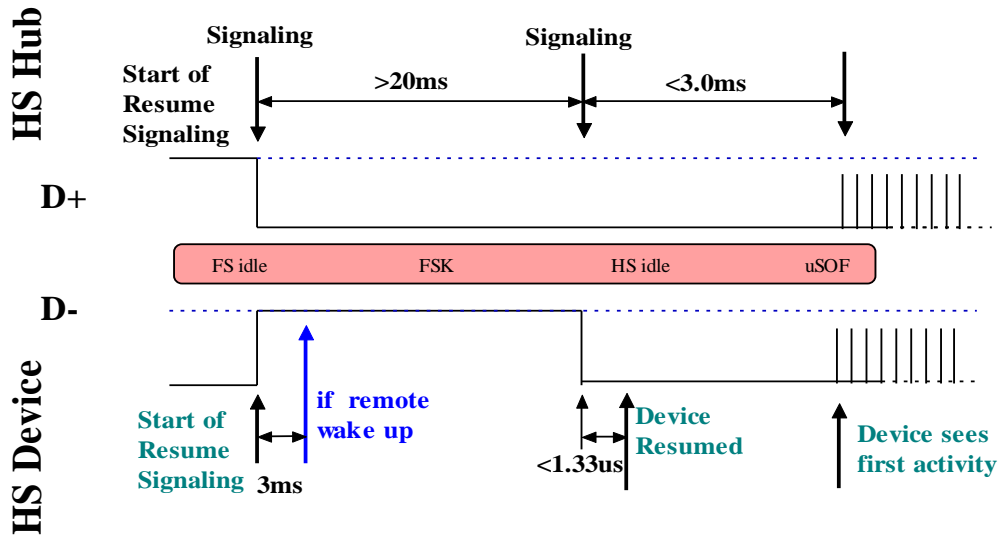

Figure 8-8 Successful procedure of remote wake-up

Transfer	F	Control	ADDR	ENDP	bRequest	wValue	wIndex	wLength	Time	Time Stamp
5	S	SET	3	0	SET_FEATURE	DEVICE_REMOTE_WAKEUP	0x0000	0	3.519 ms	8 . 897 431 766
Packet	H	Suspend								
5356		12.022 sec								8 . 900 949 650
Packet	H	Resume								
5357		21.000 ms								20 . 923 255 382
Packet	H	Resume EOP								
5358		1.333 μs								36.727 ms
6	S	GET	3	0	GET_STATUS	USB 2.0 Standard Status	2	0x0002	1.162 ms	20 . 980 983 366
7	S	SET	3	0	CLEAR_FEATURE	0x0001	0x0000	0	12.352 ms	20 . 982 145 182

WAKEUP_OUT Waking up the Host

The module will output a 1s pulse using WAKE# as shown in Figure 8-1 or WAKEUP_OUT as shown in Figure 8-2 when a wake-up source arrives. The host wakes itself up after detecting the level change.



Remote Wake-up Configuration

The power consumption of the host increases if it is frequently woken up. The host can configure the module's wake-up sources using `^WAKEUPCFG` and `^CURC` command so as to reduce the power consumption.

The `^WAKEUPCFG` command can be used to choose wake-up sources and the wake-up channel (USB or `WAKEUP_OUT`). The `^CURC` command can choose unsolicited messages. For more details, refer to AT Command Interface Specification.

8.4 Application Scenarios: System with USB Connection only

A host running Android, with support for USB suspend, USB remote resume, voice calling, and text messages.

8.4.1 Hardware Connection

The host connects to the module using USB.

8.4.2 Software Procedure

Command	Description
<code>AT^WAKEUPCFG=?</code>	Query the parameter range of WAKEUPCFG .
<code>^WAKEUPCFG: (0-1),(0-3),(0-15)</code>	
OK	
<code>AT^WAKEUPCFG=1,2,15</code>	Configure the module to make sure that incoming calls, text messages, data, and unsolicited messages can remotely wake up the host using USB.
OK	
<code>AT^CURC=?</code>	Query the parameter range of CURC .
<code>^CURC: (0-2)</code>	
OK	
<code>AT^CURC=2,820,1FFFFFFFFFFFFFFFFF</code>	The host wakes up from sleep if any of the following occurs: The SIM card state changes such as the SIM card is removed (<code>^SIMST</code>); the number of text messages exceeds the limit (<code>^SMMEMFULL</code>). Other unsolicited messages are saved in

the cache when the host is in sleep mode, and reported to the host when it wakes up.

OK

8.4.3 Advantages

With software configuration, while the system requirements (calling and text messages) are met, the number of times the host is woken up by unsolicited messages, and consequently the power consumption, are reduced.

8.5 Application Scenarios: System with USB and WAKEUP_OUT

A host running Android, with support for text messages, but not USB remote resume or voice calling.

8.5.1 Hardware Connection

The host must connect to the module using USB and WAKEUP_OUT pins

8.5.2 Software Procedure

Command	Description
AT^WAKEUPCFG=? ^WAKEUPCFG: (0-1),(0-3),(0-15) OK	Query the parameter range of WAKEUPCFG .
AT^WAKEUPCFG=1,1,14 OK	Configure the module to make sure that text messages, data, and unsolicited messages can remotely wake up the host using the WAKEUP_OUT pin.
AT^CURC=? ^CURC: (0-2) OK	Query the parameter range of CURC .
AT^CURC=2,820,1FFFFFFFFFFFFFFF	The host wakes up from sleep if either of the following occurs: The SIM card state changes, such as the SIM card is removed (^SIMST); the

number of text messages exceeds the limit (^SMEMFULL). Other unsolicited messages are saved in the cache when the host is in sleep mode, and reported to the host when it wakes up.

When the host is awake, unsolicited messages are reported to the host.

OK

8.5.3 Advantages

A solution is provided for systems not supporting USB remote resume.

With software configuration, while the system requirements (calling and text messages) are met, the number of times the host is woken up by unsolicited messages, and consequently the power consumption, are reduced.

8.6 System with Other Connection Methods

If the host can be connected to the module only using UART, refer to the [HUAWEI ME909 Series LTE LGA Module Brief Hardware Guide](#). If the host can connect to the module using USB/UART/WAKEUP_OUT and can support USB remote wake-up and UART remote wake-up, prioritize USB remote wake-up over WAKEUP_OUT remote wake-up. For details about the software procedure, refer to the earlier sections while considering the host system feature.

9 Thermal Protection Application Scenarios

9.1 Pre-configuration

Command	Description
AT^CURC=2,0x800000000,0x800000000	Enable the thermal protection unsolicited indication when the module is working or in sleep mode.
OK	
^THERM: 1	When the temperature is higher than the temperature protection threshold, the module enables thermal protection: The module turns off its RF and reports to the host.
^THERM: 0	When the temperature is lower than the temperature protection hysteresis threshold, the module disables thermal protection: turns on its RF and reports to the host.

9.1.1 Troubleshooting

None

9.2 Thermal Protection Process

- When the module's temperature is lower than 99°C, the module works normally.
- When the module's temperature is higher than 99°C, the module enables thermal protection: turns off its RF transmission and presents the **^THERM: 1** indication. When the module's temperature is lower than 85°C, the module



disables thermal protection: turns on its RF transmission, and presents the **^THERM: 0** indication.

Notes:

- During an emergency call, if thermal protection is enabled, the module will present an indication but will not take thermal protection actions such as turning off its RF or shutting down.
- After thermal protection is enabled, users cannot make emergency calls.
- Thermal protection is designed to protect the module from being damaged by overtemperature. To work in high temperature environments, both the module and its peripheral components must be able to resist the same temperature.

10

Module Powering Off and Resetting Application Scenarios

10.1 Restarting the ME

10.1.1 Reference Process

Command	Description
AT+CFUN=1,1	Restart the module.
OK	

The ME can be reset or restarted using the **AT+CFUN** command. After the restart, the module must register with the network and authenticate its SIM card's PIN.

10.1.2 Troubleshooting

None

10.2 Power Off ME

10.2.1 Reference Process

Command	Description
AT^MSO	Power off the module.
OK	

After the command is received, the module will only do the preparative work of power-off such as deregister. The host should cut off the power in order to finish the power-off operation.



10.2.2 Troubleshooting

None

11 Appendix

11.1 Relative Documents

1. HUAWEI ME909u-521 LTE LGA Module AT Command Interface Specification
2. 3GPP 27.007 AT command set for User Equipment (UE)
3. 3GPP 27.005 Equipment (DTE-DCE) interface for Short Message Service (SMS) and Cell Broadcast Service (CBS)
4. 3GPP 23.040 Technical realization of the Short Message Service(SMS)
5. 3GPP 31.102 Universal Subscriber Identity Module(USIM) application
6. 3GPP 24.008 Mobile radio interface Layer 3 specification; Core network protocols; Stage 3
7. 3GPP 29.002 Mobile Application Part (MAP) specification
8. 3GPP 22.004 General on supplementary services
9. ETSI TS 102.221 Smart Cards; UICC-Terminal interface; Physical and logical characteristics

11.2 Acronyms and Abbreviations

Table 11-1 List of Abbreviations

Acronym or Abbreviation	Expansion
3GPP	Third Generation Partnership Project
APN	Access Point Name
AT	Attention
CS	Circuit Switched (CS) domain
DCE	Data Circuit Equipment
DTE	Data Terminal Equipment
GPRS	General Packet Radio Service
GSM	Global System for Mobile Communications

Acronym or Abbreviation	Expansion
IMEI	International Mobile Equipment Identity
IP	Internet Protocol
LTE	Long Term Evolution
ME	Mobile Equipment
MS	Mobile Station
PDP	Packet Data Protocol
PDU	Protocol Data Unit
PIN	Personal Identity Number
PPP	Point-to-Point Protocol
PUK	PIN Unblocking Key
PS	Packet Switched (PS) domain
QoS	Quality of Service
SIM	Subscriber Identity Module
SMS	Short Message Service
TE	Terminal Equipment
UE	User Equipment
UMTS	Universal Mobile Telecommunications System
USIM	Universal Subscriber Identity Module
WCDMA	Wideband CDMA

Table 11-2 Phonebook-related abbreviations

Abbreviation	Full Name
SM	SIM phonebook
EN	SIM emergency number
ON	SIM own numbers

Free Manuals Download Website

<http://myh66.com>

<http://usermanuals.us>

<http://www.somanuals.com>

<http://www.4manuals.cc>

<http://www.manual-lib.com>

<http://www.404manual.com>

<http://www.luxmanual.com>

<http://aubethermostatmanual.com>

Golf course search by state

<http://golfingnear.com>

Email search by domain

<http://emailbydomain.com>

Auto manuals search

<http://auto.somanuals.com>

TV manuals search

<http://tv.somanuals.com>