

INSTALLATION and MAINTENANCE INSTRUCTIONS

UE24 UNIVERSAL CABLE REEL-DIRECT DRIVE

All units are provided with right hand rotation unless otherwise specified. This means that cable is pulled off spool top left or bottom right (spool rotates clockwise to wind cable) **when viewing spring end of reel**. See diagram on parts page.

Clock-type springs provide power for automatic cable take-up. **Spring must be pretensioned at time of installation** to insure that tension is applied to cable at all times. A tension adjustment spanner wrench is provided with each reel.

⚠ WARNING

Some reels with large or multiple springs are equipped with a ratcheted adjustment wrench. Follow separate instructions for its use. Failure to use ratcheted wrench, on reels so equipped, could result in serious personal injury.

⚠ WARNING

Do not attempt to relieve spring tension using spanner wrench. Doing so may result in personal injury.

INSTALLATION

1. Insure that machinery to be serviced by reel is at position closest to reel.
2. Securely mount reel in desired position using 1/2"(M12) bolts. Be sure spool is aligned with cable run.
3. Position optional cable guide, if reel is so equipped. See COMPONENT REFERENCE DRAWING.
4. Connect free end of cable to junction box on machine or adjust cable stop so that desired length of cable extends from reel.
5. Remove cover plate on spring housing to expose shaft and spring hub. (See Figure 1).
6. Insert spanner wrench into holes in spring hub (Fig 2). Rotate wrench counterclockwise (for standard rotation). Number of 360° turns should match last digit in model number on serial plate. *If model number includes an "R", reel is reverse rotation and wrench must be rotated clockwise.* (See "TO DETERMINE ROTATION OF REEL" on parts drawing page.)

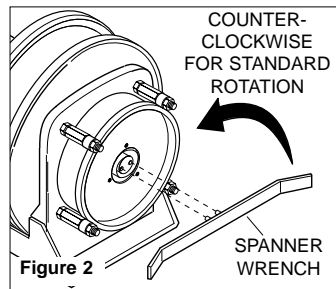
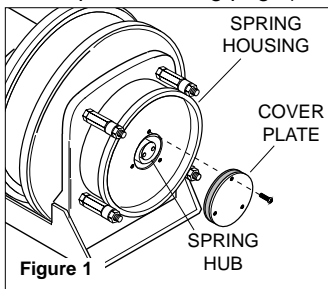

⚠ CAUTION

Do not exceed number of turns indicated on serial plate. Over-tensioning can cause a broken spring, sheared shaft or other damage.

NOTE: If reel is equipped with ratcheted adjustment wrench, follow instructions on separate sheet.

NOTE: On reels containing more than one spring, the hubs are connected at the factory. Therefore, by tightening the outer spring, the inside spring(s) will be tightened.

7. Remove collector cover and connect individual supply conductors to collector terminals. See ELECTRICAL CONNECTIONS diagram, on back page.

MAINTENANCE

Periodically: A. Use compressed air to clean collector assembly and inside of collector housing. Inspect collector assembly for brush wear and pitted slip rings.

B. Inspect cable for wear and check mounting bolts and other hardware for tightness.

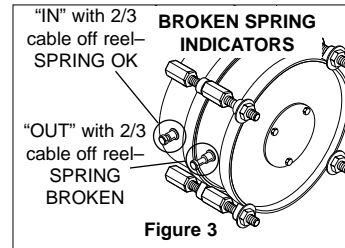

C. Check for broken springs by pulling about 2/3 cable off reel and observing "Broken Spring Indicators" on sides of spring canisters. See Fig. 3.

NOTE: Bearings and springs are prelubricated and require no periodic maintenance.

SPRING REPLACEMENT

⚠ WARNING

Do not attempt to remove spring from its housing. Clock-type springs can be dangerous to handle. Removal of spring from housing could result in personal injury.

The unique SAFETYCHANGE® spring motor consists of a spring and hub sealed within a housing. A replacement spring is supplied sealed in its housing and the old unit should be discarded completely.

1. Turn off all electric power.
2. Disconnect cable from machine junction box.
3. Wind all cable onto reel to relieve all spring tension.
4. Remove inspection cover from face of spring housing.
5. Rotate spool clockwise and observe inner shaft. Shaft should rotate clockwise and hub (with spring attached) should remain stationary.

NOTE: Do not attempt to remove spring if resistance is met or hub tends to rotate with shaft.

6. Continue to rotate spool and strike end of shaft several sharp blows with a lead hammer or rubber mallet until shaft rotates freely and hub remains stationary.
6. Remove (4) nuts which secure spring motor(s) to frame.
7. Slide spring motor(s) off shaft and discard.

NOTE: On multi-spring reels, be sure to remove and **save** dowel pins which connect one spring hub with another. Also remove snap rings on shaft between reel housings.

8. Install replacement spring motor(s), pawls and pawl springs.

NOTE: Pawl springs must be located between the pawls and the deepest section of the shaft grooves. Make sure that pawls and pawl springs are inserted flush with ends of shaft and hub or they may rub against inspection cover.

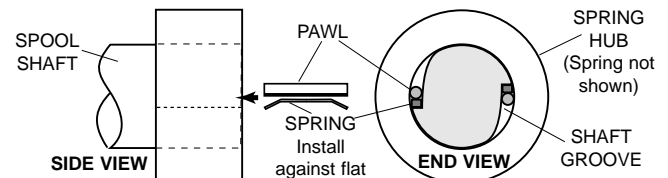

9. Tighten nuts (and extension bolts) securing spring housing(s) to reel frame.
10. Connect free end of cable to junction box on machine or adjust cord stop so that desired length of cord extends from reel.
11. Tension spring with spanner wrench. Refer to **INSTALLATION** section.
12. Replace inspection cover.

CONTINUED ON BACK PAGE →

DIRECT DRIVE UE-24 UNIVERSAL CABLE REEL REPLACEMENT PARTS LIST

ITEM	PART NO.	DESCRIPTION	QTY.
1	042017	Vertical Frame Assy., Swivel Side	1
2	012140	Housing, 2" Bore Bearing	2
3	103837	Ball Bearing, 2" Bore	1
4	038424	Flat Washer, M8	9
5	028268	ESNA Lock Nut, M8-1.25	8
6	042007	Vertical Frame Assy., Drive Side	1
7	119114	Housing, 1.75" Bore Bearing	2
8	103823	Ball Bearing, 1.75" Bore	1
9	042030	Spool Support Hub, Drive Side	1
10	012137	Stub Shaft Drive Pin	1
11	118322	Retaining Ring	1
12	042027	Spool Disk, U24	2
13	04271001	Wrapper Assy. Kit, 6"w, 10"-12"dia. core <i>(Includes segments & hardware)</i>	1
13	04271002	Wrapper Assy. Kit, 8"w, 10"-12"dia. core	1
13	04271003	Wrapper Assy. Kit, 10"w, 10"-12"dia. core	1
13	04271004	Wrapper Assy. Kit, 12"w, 10"-12"dia. core	1
13	04271005	Wrapper Assy. Kit, 14"w, 10"-12"dia. core	1
13	04271006	Wrapper Assy. Kit, 6"w, 14"-18"dia. core	1
13	04271007	Wrapper Assy. Kit, 8"w, 14"-18"dia. core	1
13	04271008	Wrapper Assy. Kit, 10"w, 14"-18"dia. core	1
13	04271009	Wrapper Assy. Kit, 12"w, 14"-18"dia. core	1
13	04271010	Wrapper Assy. Kit, 14"w, 14"-18"dia. core	1
13	04271011	Wrapper Assy. Kit, 6"w, 20"-26"dia. core	1
13	04271012	Wrapper Assy. Kit, 8"w, 20"-26"dia. core	1
13	04271013	Wrapper Assy. Kit, 10"w, 20"-26"dia. core	1
13	04271014	Wrapper Assy. Kit, 12"w, 20"-26"dia. core	1
13	04271015	Wrapper Assy. Kit, 14"w, 20"-26"dia. core	1
14	042068	Spool Hub, Collector Side	1
15	Consult Factory	Cable Clamp/Connector Kit <i>(Includes Cable Clamp, Cable Connector & Reducer, if required, sized for cable diameter)</i>	1
16	040784	Collector Entrance	1
17	101652	Pipe Plug	1
18	118220	Gasket, Collector Entrance	1
19	012409	Collector Cover Kit (8" long) <i>(Includes seal ring)</i>	1
19	012410	Collector Cover Kit (10.5" long)	1
19	012411	Collector Cover Kit (13" long)	1
19	012412	Collector Cover Kit (15.5" long)	1
19	012413	Collector Cover Kit (20.5" long)	1
19	012414	Collector Cover Kit (28.5" long)	1
20	012458	Seal Ring Only	1
21	042067	Collector Drive Stop	1
22	028138	Lockwasher, M10	4
23	028131	Hex Hd. Cap Screw, M10-1.5 x 20L	4
24	04272201	Bottom Base Kit, 6" wide Wrapper <i>(Includes mounting hardware)</i>	1
24	04272202	Bottom Base Kit, 8" wide Wrapper	1
24	04272203	Bottom Base Kit, 10" wide Wrapper	1
24	04272204	Bottom Base Kit, 12" wide Wrapper	1
24	04272205	Bottom Base Kit, 14" wide Wrapper	1
25	042152	Stub Shaft, 1002, Direct, Standard Rotation	1
25	042153	Stub Shaft, 1001, Direct, Standard Rotation	1
25	042156	Stub Shaft, 802/622/752, Direct, Std. Rot.	1
25	042157	Stub Shaft, 801/621/751, Direct, Std. Rot.	1
25	042554	Stub Shaft, 351, Direct, Standard Rotation	1
25	042160	Stub Shaft, 1002, Direct, Reverse Rotation	1
25	042161	Stub Shaft, 1001, Direct, Reverse Rotation	1
25	042164	Stub Shaft, 802/622/752, Direct, Rev. Rot.	1
25	042165	Stub Shaft, 801/621/751, Direct, Rev. Rot.	1
25	042566	Stub Shaft, 351, Direct, Reverse Rotation	1

ITEM	PART NO.	DESCRIPTION	QTY.
26	012425	Pawl Kit (35 Spring) <i>(Includes 2 pawls & springs)</i>	AR
26	012426	Pawl Kit (62, 75 & 80 Springs)	AR
26	012427	Pawl Kit (100 Spring)	AR
27	031484	Hex Hd. Cap Screw, M12-1.75 x 35L	4
28	025942	Lockwasher, M12	4
29	025941	Hex Nut, M12-1.75	4
30	042555	Stand-off, 35 Springs	AR
30	042183	Stand-off, 62, 75 & 80 Springs	AR
30	042182	\Stand-off, 100 Spring\	VAR
31	029159	\Flat Washer, M12	4
32	028502	ESNA Nut, M12-1.75	4
33	042727	Spring Motor Kit, 35, Standard Rotation <i>(Includes items 20, 27, 28, 29, & 30)</i>	AR
33	042725	Spring Motor Kit, 62, Standard Rotation	AR
33	042726	Spring Motor Kit, 75, Standard Rotation	AR
33	042724	Spring Motor Kit, 80, Standard Rotation	AR
33	042723	Spring Motor Kit, 100, Standard Rotation	AR
33	042732	Spring Motor Kit, 35, Reverse Rotation	AR
33	042730	Spring Motor Kit, 62, Reverse Rotation	AR
33	042731	Spring Motor Kit, 75, Reverse Rotation	AR
33	042729	Spring Motor Kit, 80, Reverse Rotation	AR
33	042728	Spring Motor Kit, 100, Reverse Rotation	AR
34	G51-23	Gasket, Hub Cover	1
35	G27-42	Hub Cover, Springs	1
36	101220	Screw, #8-32 x 0.25" Lg	3
37	021762	Hub Lock Pin Kit (100 Springs) <i>(Includes two pins)</i>	1
37	021761	Hub Lock Pin Kit (All Other Springs)	1
38	012285	Collector Assembly, 2 Pole, 35 Amp	1
38	012286	Collector Assembly, 3 Pole, 35 Amp	1
38	012287	Collector Assembly, 4 Pole, 35 Amp	1
38	012288	Collector Assembly, 6 Pole, 35 Amp	1
38	012289	Collector Assembly, 8 Pole, 35 Amp	1
38	012290	Collector Assembly, 10 Pole, 35 Amp	1
38	012291	Collector Assembly, 12 Pole, 35 Amp	1
38	012292	Collector Assembly, 14 Pole, 35 Amp	1
38	012293	Collector Assembly, 16 Pole, 35 Amp	1
38	012294	Collector Assembly, 20 Pole, 35 Amp	1
38	012295	Collector Assembly, 24 Pole, 35 Amp	1
38	012296	Collector Assembly, 30 Pole, 35 Amp	1
38	012297	Collector Assembly, 36 Pole, 35 Amp	1
38	012298	Collector Assembly, 2 Pole, 75 Amp	1
38	012299	Collector Assembly, 3 Pole, 75 Amp	1
38	012300	Collector Assembly, 4 Pole, 75 Amp	1
38	012376	Collector Assembly, 6 Pole, 75 Amp	1
38	037194	Collector Assembly, 2 Pole, 125 Amp	1
38	012377	Collector Assembly, 8 Pole, 75 Amp	1
38	037294	Collector Assembly, 3 Pole, 125 Amp	1
38	037295	Collector Assembly, 4 Pole, 125 Amp	1
38	012304	Collector Assembly, 2 Pole, 200 Amp	1
38	012381	Collector Assembly, 3 Pole, 200 Amp	1
38	012382	Collector Assembly, 4 Pole, 200 Amp	1
38	012383	Collector Assembly, 6 Pole, 200 Amp	1
38	012384	Collector Assembly, 8 Pole, 200 Amp	1
39	012440	Brush Kit (35 Amp) <i>(Each kit includes 4 brushes and 4 fingers)</i>	ar
39	012441	Brush Kit (75 Amp)	ar
39	012443	Brush Kit (125 Amp/200 Amp)	ar
40	042733	Spanner Wrench (35-80 Springs) <i>(Includes mounting hardware)</i>	1
40	042734	Spanner Wrench (100 Springs)	1
41	042735	Ratchet Wrench Kit (35-80 Springs) <i>(Includes mounting hardware)</i>	1
41	042736	Ratchet Wrench Kit (100 Springs)	1

MODEL NUMBER STRUCTURE

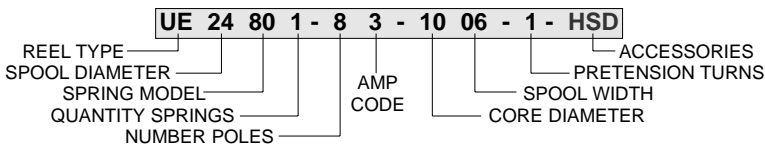

AMPACITY CODE

CODE	AMPS
3	35
7	75
12	125
20	200

ACCESSORY CODE

(See next page for accessories)

340° Pivot Base = P
 Dog & Ratchet (ratchet lock) = D
 Limit Switch = L
 Horizontal Roller Guide = H
 Vertical Roller Guide = V
 Spool Lock = S

TO DETERMINE ROTATION OF REEL

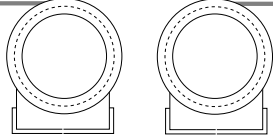

STANDARD ROTATION
REVERSE ROTATION

Cable is played out and retracted as shown when viewing reel from spring motor side.

Always specify
SERIAL NUMBER & MODEL NUMBER
when ordering parts.

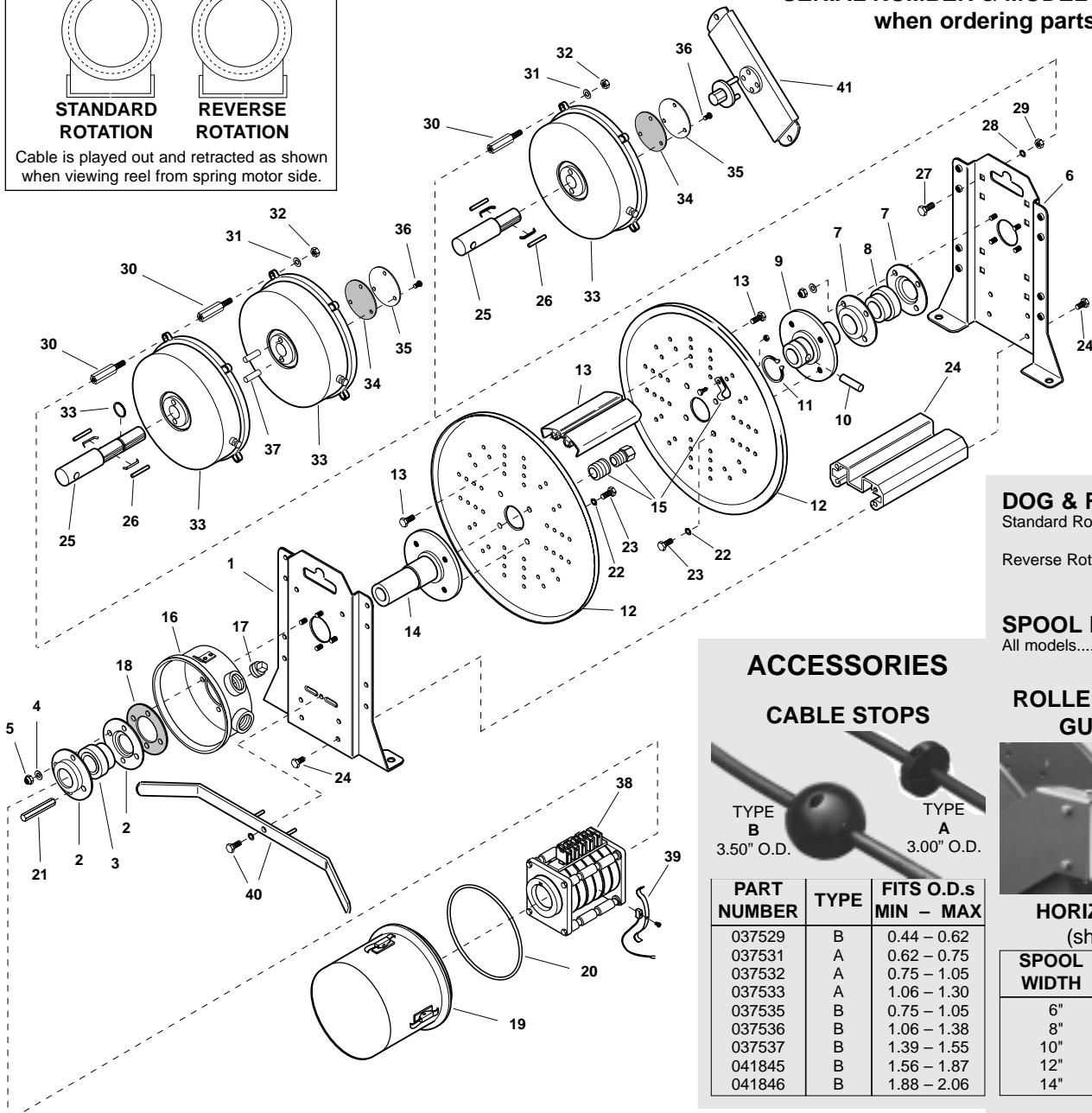

DOG & RATCHET
Standard Rotation.... P/N 042230
Reverse Rotation.... P/N 042231

SPOOL LOCK
All models....P/N 042227

ACCESSORIES

CABLE STOPS



TYPE B 3.50" O.D.
TYPE A 3.00" O.D.

ROLLER CABLE GUIDES



HORIZONTAL
(shown)

SPOOL WIDTH	PART NUMBER
6"	042200
8"	042201
10"	042202
12"	042203
14"	042204

VERTICAL

SPOOL WIDTH	PART NUMBER
6"	042270
8"	042271
10"	042272
12"	042273
14"	042274

340° PIVOT BASE

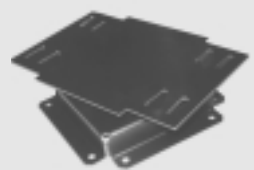

SPOOL WIDTH	PART NUMBER
4"-6"	042284
8"-10"	042285
12"-14"	042286

COMPONENT REFERENCE DRAWING

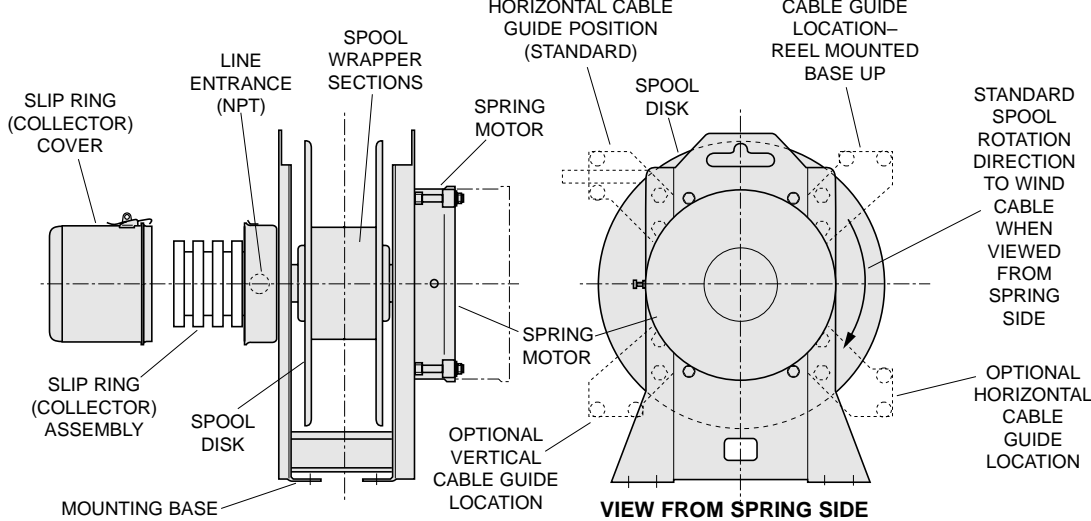

CABLE REMOVAL

Use the following procedure to remove worn or damaged cable from reel prior to installation of new cable.

⚠ CAUTION

Failure to relieve all spring tension prior to removing cable could result in damage to equipment or personal injury. Follow instructions carefully.

1. Move machine serviced by reel to a position closest to reel. Springs will still be under pre-tension at this point.
2. Turn off all electric power.
3. Lock spool to prevent turning using either a spool lock mechanism or by tying off.
4. Disconnect cable from machine junction box.
5. Grip spool by hand and **carefully** release spool lock or tie. Slowly unwind remaining tension.
6. Again lock or tie spool to prevent rotation.
7. Remove cable from spool. Loosen cable clamp and water-tight connector. Disconnect conductors from slip ring and remove cable.
8. Install new cable following instruction at right.

CABLE INSTALLATION

Use the following procedure to replace cable or if reel was ordered without cable. Refer to ELECTRICAL CONNECTIONS DRAWING, below.

1. Unspool new cable from shipping spool and lay out to eliminate twist.

NOTE: This step is not essential, but will aid in winding operation of the reel and prolong cable life.

2. Feed one end of the cable through water-tight connector on the spool hub inside the spool and into the slip ring. (See drawing below).

NOTE: This may require that jacket of cable be stripped to allow conductors to pass through shaft.

3. Connect individual conductors to appropriate rings on collector using crimp fitting or similar connection method.
4. Tighten water-tight connector. Place cable clamp on cable and securely fasten to spool disk.
5. Wind the cable onto the reel spool by hand rotating spool in direction it turns free of spring tension.
6. Connect free end of cable to machine junction box.
7. Pretension reel and complete installation as previously described.

COLLECTOR REPLACEMENT

1. Turn off all power to reel.
2. Remove collector cover and gasket.
3. Disconnect electric leads to and from collector.
4. Remove button plug from hole in side of housing. Insert long 1/8" Allen wrench through hole and loosen two set screws in collector locking collar. Set screws are at 90° to one another..
5. Slide collector off shaft.
6. Install new collector by reversing above steps.

ELECTRICAL CONNECTIONS

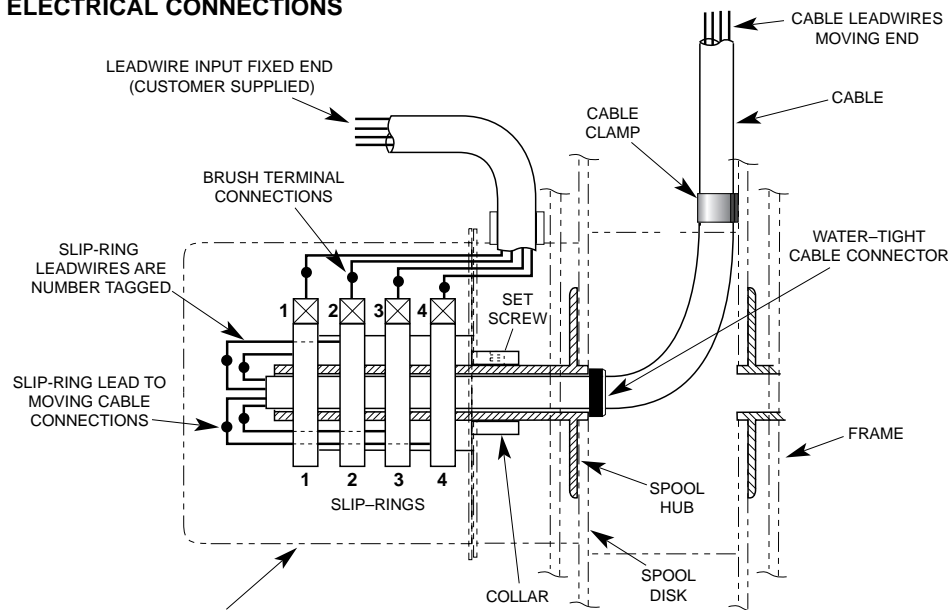

SLIP-RING ENCLOSURE

- 600 VOLT AC. 250 VOLT DC. WATERTIGHT, DUST TIGHT.
- DO NOT EXCEED AMPERAGE RATING OF CABLE OR SLIP RING.
- NUMBER OF CIRCUITS MAY VARY FROM TWO (MINIMUM) TO 36 (MAXIMUM). FOUR CIRCUITS SHOWN.

NOTE:

Wire size, wire connectors, connection sequence, and connection methods must comply with National Electrical code and Local Electrical ordinances. If in doubt, contact a local electrical contractor or electrical inspector.

COLOR SEQUENCE FOR TYPE SO CABLE THREE CONDUCTOR CABLE

- # 1 - BLACK
- # 2 - WHITE
- # 3 - GREEN (ground)

FOUR THRU TWELVE CONDUCTOR CABLE

- # 1 - BLACK
- # 2 - WHITE
- # 3 - RED
- # 4 - GREEN (ground)
- # 5 - ORANGE
- # 6 - BLUE
- # 7 - WHITE W/ BLACK TRACER
- # 8 - RED W/ BLACK TRACER
- # 9 - GREEN W/ BLACK TRACER
- # 10 - ORANGE W/ BLACK TRACER
- # 11 - BLUE W/ BLACK TRACER
- # 12 - BLACK W/ WHITE TRACER



GLEASON REEL CORP.
P.O. Box 26 • 600 South Clark St.
Mayville, WI 53050-0026
Phone 920-387-4120 • Fax 920-387-4189

Free Manuals Download Website

<http://myh66.com>

<http://usermanuals.us>

<http://www.somanuals.com>

<http://www.4manuals.cc>

<http://www.manual-lib.com>

<http://www.404manual.com>

<http://www.luxmanual.com>

<http://aubethermostatmanual.com>

Golf course search by state

<http://golfingnear.com>

Email search by domain

<http://emailbydomain.com>

Auto manuals search

<http://auto.somanuals.com>

TV manuals search

<http://tv.somanuals.com>