

zenTera

DSM™ - MODELING GUITAR COMBO

ENGLISH

MANUAL

Hughes & Kettner
TECHNOLOGY OF TONE





zenTera

DSM™ - MODELING GUITAR COMBO

TABLE OF CONTENTS

1.0	QUICK START GUIDE OR OPERATING MANUAL?	6
2.0	POWERING UP	6
3.0	AMP MODELS AND EFFECTS	6
3.1	AMP MODELS	6
3.2	EFFECTS	7
4.0	STANDARD SETUP/CABLE CONNECTIONS	7
5.0	JACKS AND CONTROL FEATURES	7
5.1	OVERVIEW	7
5.2	THE ZENTERA®'S DISPLAY	7
5.3	JACKS AND CONTROL FEATURES IN DETAIL	8
6.0	SPECIAL FUNCTIONS	11
6.1	PRE EFFECT MODE	11
6.2	GLOBAL EQ	11
6.3	TUNER	11
6.4	STORE (NAME)	12
6.5	FOOTSWITCH	12
6.6	TAP	12
7.0	THE SYSTEM MENU	12
7.1	MEMORY PROTECTION	12
7.2	MODE	12
7.3	WAKE UP	12
7.4	READ VALUES	13
7.5	MIDI SETUP BASE CHANNEL	13
7.6	MIDI PROGCHG	13
7.7	MIDI SETUP DEVICE ID	13
7.8	MIDI SYSEX SEND	13
7.9	MIDI SYSEX RECEIVE	13
7.10	MIDI DUMP	13
7.11	MIDI MAPPING	13
7.12	FOOTSWITCH ASSIGN	13
7.13	VOLUME PEDAL	14
7.14	VOL. PEDAL RANGE MIN., VOL. PEDAL RANGE MAX.	14
7.15	CV PED TYPE	14
7.16	CV PED CALIB MIN/MAX	14
7.17	Z-BOARD BANK CHANGE	14
7.18	Z-BOARD CALIB	14
7.19	VERSION	14
8.0	MAINTENANCE AND CARE	14
9.0	TROUBLESHOOTING	14
10.0	TECHNICAL SPECIFICATIONS	15
11.0	APPENDIX	15
11.1	TABLE: EFFECTS AND EFFECT PARAMETERS	15
11.2	MIDI IMPLEMENTATION CHART	28
11.3	AC POWER AND THE GLOBAL CURRENT ADAPTER	31

GLOSSARY OF SYMBOLS

-  Turn knob
-  Tap knob or button (click)
-  Tap knob or button twice (double-click)
-  Hold knob or button pressed for a bit longer (click and hold briefly)

CONGRATULATIONS AND THANK YOU FOR CHOOSING THE ZENTERA!

The **zenTera**® converges the most sought-after amps and effects in the history of guitar amplification in an easy-to-handle, combo-sized package. And it does it with mind-bending authenticity, delivering an audio experience you won't soon forget.

The secret behind the **zenTera**®'s sonic sorcery is Dynamic Sector Modeling (DSM™). We poked and probed every group of components (sectors) in the original amps and we analyzed the dynamic interaction between these sectors. One of the things we found is that tone is a sum greater than its many parts and that it is the musical quality of the individual component groups and their dynamic reciprocation that make the difference. These findings flowed into the making of digital models. Thus the **zenTera**® is able to faithfully replicate each amp, the full sweep of its dynamic range, its inherent sonic personality, and all its unique sound-shaping options.

Another example of the **zenTera**®'s innovative technology is the 24-bit A/D converter in its preamp section. Tweaked specifically for processing guitar signals, it enables the **zenTera**® to handle signal peaks of up to 116 decibels. This makes the **zenTera**® the world's first digital amp that is able to capture the full dynamic range of the guitar. Until now this extraordinary dynamic range was solely the domain of tube amps.

But that's not all: In the engine room of the **zenTera**® there toil not one but two of the latest-generation 32-bit floating point DSPs. Their computing power is what translates the technology of DSM™ into soul-stirring, to-die-for tone. Furthermore, they guarantee that the **zenTera**® reproduces signals without any perceptible latency. But the bottom line is tone, and **zenTera**® delivers it in truckloads replete with dynamics galore and lively, utterly true responsiveness to your attack.

In the **zenTera**® you have 11 different amp models at your fingertips. Each amp type's tone controls respond faithfully as if you were tweaking your tone on the original. This lets you dial in every sound swiftly and intuitively just like you are accustomed to doing on analog amps. But there's more cooking in the **zenTera**®'s sonic kitchen - a smorgasbord of studio-quality effects, emulations of vintage stomp boxes and a faithfully replicated spring reverb. These effects, just like the amp's parameter controls, are intuitive to tweak, without the nerve-racking tedium of stepping through menus. All settings may be stored as presets in 128 slots (100 user presets + 28 factory sounds) and called up via the front panel, footswitch or MIDI controllers. With this array of user-friendly features, the **zenTera**® handles like a dream.

Packing a powerful punch, the **zenTera**®'s beefy 2 x 100 W stereo power amp is coupled with two Celestion Vintage 30 loudspeakers. This combination cuts through the din at any stage volume and enables you to make your musical statement under even the most demanding conditions.

A built-in tuner, a TAP function that lets you sync up delay time, a serial FX loop, an analog and digital recording output, a headphones jack and many other practical features give you the remarkable level of convenience that you've come to expect from Hughes & Kettner gear.

With the **zenTera**®, you've bought a stake in the future. Its MIDI interface lets you upload software upgrades at any time and even swap sounds and system settings with other **zenTera**® owners.

HERE'S HOPING THAT YOU GET AS BIG A KICK OUT OF THE ZENTERA'S TONE AS WE DID DEVELOPING THE TECHNOLOGY BEHIND IT!

BEFORE POWERING UP - Check and make sure that the local current and the amp's AC power rating are identical before you plug the zenTera's mains cord into an AC outlet. - Ensure that air can circulate freely around your amp's ventilation ducts. - Place the amp on a stable platform where it is not exposed to mechanical shocks and will not endanger the safety of anyone nearby. Avoid temperature extremes and excessive humidity, both of which can damage the amp and may cause an electrical shock. - The manufacturer is not liable for any damage to the amp due to improper use. Important information! Note that the zenTera should not be exposed to extreme cold over longer periods. Though unlikely, it is possible that the internal battery will lose its charge. This battery provides power to the system when it is switched off. Under normal conditions, it is recharged when you power the amp up.

1.0 QUICK START GUIDE OR OPERATING MANUAL?

We've included a quick guide for all those who are raring to go right now and can't be bothered to wade through the entire owner's manual. In just a few steps, it will familiarize you with the sound-shaping features of the zenTera® and explain its key functions. Even if this quick guide provides enough information to let you get off to a good start, please bear in mind that the zenTera®'s possibilities are legion. You won't find out about all of them until you take the time to read the owner's manual.

2.0 POWERING UP

Activate the zenTera® by flipping the POWER switch located on the far right. The zenTera® will go on line in one of two statuses, loading either the preset that was active before the amp was switched off or the last setting that was dialed in before the amp was switched off. These two possibilities are explained in greater detail in section 7.3, WAKE UP.

3.0 AMP MODELS AND EFFECTS

3.1 AMP MODELS

You can select from among eleven different models of amps - herein called amp types - by rotating the zenTera's  AMP TYPE knob. Every amp type has a distinctive sonic personality that is best suited for very specific styles of music. In addition to vintage milestones that literally made amp history, the zenTera® also offers emulations of some contemporary amps. In the following, we'll take a quick look at each amp type.

BLACK FACE

This American beauty is the definitive amp for classic clean tone. Although you'd be hard-pressed to drive it into the distortion zone, its big sound and enormous punch left an indelible mark on several of styles of music - it even helped shape certain playing techniques. This piece of gear has won friends and influenced people far and wide, from funk rhythm kings to jazz masters, from blues howlers to country pickers.

Note that the BRIGHT function found on the original is integrated into the zenTera's GAIN knob. GAIN settings of up to 5.0 (12 o'clock position) elicit that characteristic treble boost of the original's BRIGHT switch. The top end is not boosted at higher settings.

TWEED DELUXE

The kid brother of the big tweed amp, its raw, throaty textures are held in high esteem by connoisseurs of vintage grit. A purist's dream come true, its simple yet brilliant circuitry delivers earthy, fat tweed tone unrivaled by any other amp.

On the downside, the original was equipped with just one tone knob, so we elected to assign a sound-shaping functionality to the 3-band EQ and the PRESENCE knob for this emulation. This gives you a lot more musically meaningful tweaking options without sacrificing the tone that makes this amp type so special.

TWEED 4 x 10

The ultimate vintage blues amp revered by almost all historic greats of the genre, it still spells bliss for many a modern-day blues blaster. The breadth and depth of its dynamic range and its fat, expressive lead tone are what made it famous. From squeaky clean to a throaty growl and all points in between, this amp puts meaning into the phrase "living on blues power."

BRIT EL 84

The amp for classic guitar-driven pop and rock. Judging by the many stellar songwriters who appear on its reference list, this amp would undoubtedly be the hands-down winner in a poll of song-smiths. Unarguably, its EL84-loaded, Class A power amp delivers the sweetest harmonic distortion of all tube amps. And its flexible tone controls with the legendary Cut and Top Boost circuits elicit chiming, sparkling sounds as well as fat lead tone. Cranked wide open, it also delivers gritty, roots rock-approved goods.

Note that the zenTera's PRESENCE knob takes over the CUT function. The Top Boost circuit is integrated into the MID knob, which is handy because this lets you dial smoothly rather than switch hard from Normal to Top Boost mode.

PLEXI 50

This British EL34-powered classic made music history. Many a genre-defining steel-string slinger welded its considerable sonic clout to leave an indelible mark on the face of modern music. With its hair-trigger response, the PLEXI will do exactly what the position of your guitar's volume knob tells it to. Turn the volume down low, and you get fat, clean tone with shimmering top end. As you crank the knob, you can hear that vintage rock roar unfold.

PLEXI 100

The PLEXI on steroids, this 100-watt sensation literally rocked the late '60s and continued to dominate the heavy rock scene throughout the '70s and well into the '80s. A staple of innumerable rock productions, this amp's dynamic response made it the tool of choice for many an audio alchemist. Indeed, it can be said with some authority that this beast's big, cutting sound defined what great rock tone is all about. It will also make you the object of fear and loathing in your neighborhood, because you won't feel the full fury of its sonic assault until you crank it to the hilt.

BRIT HI GAIN

A logical outgrowth of the razor-edged sound of British steel, this amp delivers gear-grinding overdrive and meltdown lead sounds with truck-loads of sustain and in-your-face punch. The tone controls are tweaked to deliver the response of a modern-day boutique amp, adding many shades and hues to your sonic palette. Less subtly, its scooped mids elicit a merciless metal edge, while its over-the-top high end has been removed to peal paint at a hundred paces.

ULTRA GAIN

A zenTera® special, this is what you get when you hop up a British 100-watt amp until it is hot enough to roast weenies. And, frankly, the result is awe-inspiring - the fattest and most creamy lead sound imaginable.

USA HI GAIN

This amp's peerless tone is the product of three rectifier tubes. A real firecracker, it throws red-hot sparks of distortion for a fresh, dynamic tone. With its fat, bad and downright angry overdrive, this amp can take on many guises. Playing a key role in the rise of grunge in the '90s, it has since become the tool of choice for New Metal merchants. And with good reason, for few other amps can match its intensity and depth of musical expression, particularly for soloing.

ACOUSTIC AMP

This is the DSM™ version of the Montana, Hughes & Kettner's acoustic amp.

JAZZ CLEAN

This amp type is based on a Hughes & Kettner rig that debuted back in the '80s, specifically the clean channel of the AIS 112, which many jazz guitarists still consider a benchmark for this style.

3.2 EFFECTS

The **zenTera** offers an arsenal stocked with hip yet practical effects for which the gigging guitarist will find plenty of use. In addition to standard reverb, delay and modulation effects, the archive also features emulations of classic stomp boxes (e.g. fuzz) and vintage effect devices (e.g. tape echo devices). An excellent spring reverb simulation is also onboard. To learn more about the amp's effects offerings, check out Chapter 6.1, PRE EFFECT MODE, and the tables depicted under heading 11.1 in the appendix.

4.0 STANDARD SETUP/CABLE CONNECTIONS

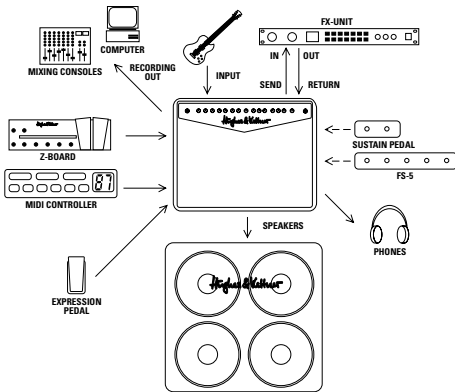

5.0 JACKS AND CONTROL FEATURES

5.1 OVERVIEW

The **zenTera**'s user panel is essentially divided into two segments, the amp section and the effect section.

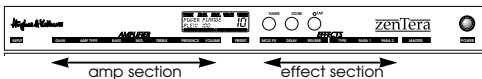

The layout of the amp section should look familiar to you - it is arranged much like that of an analog amp. The GAIN, BASS, MID, TREBLE, PRESENCE and VOLUME knobs rotate to a far left and far right position. You can dial in values of 0 to 10. Only the AMP TYPE knob spins completely around.

The knobs of the selected amp type respond just like those on the original model, which means that in this respect the **zenTera** handles exactly like its analog forebears. In some cases, however, it gives you additional tweaking options beyond those of the original. This bit of icing on what was already a great cake is no novelty feature. You'll find that the extra sound-shaping options come in handy and that they make musical sense.

The effect section puts an array of delay, modulation and reverb effects at your disposal. Here you'll find it easy to dial in satisfactory sounds without a great deal of editing. All effects can be switched PRE or POST preamp.

PRE is comparable to a stomp box that plugs into the front panel input. The latter option taps into the stereo signal circuit located before the power amp, giving you stereo effects.

5.2 THE ZENTERA'S DISPLAY

The **zenTera**'s display responds immediately to each handling operation and menu change. It always indicates the parameter that you are currently editing and jumps to the next display as soon as you activate another knob or menu. **There's one exception - the amp's master level (as determined by the MASTER knob on the far right) is independent of all other settings. Note that the master volume is not indicated in the display.**

In standard display mode, the **zenTera** indicates the name of the preset, the number of its memory slot, the name of the amp simulation as well as any effect blocks that you may have activated. The following diagram should clear up any questions you might have about what's what in the display.

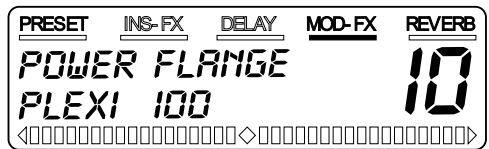

Large numerical display:

number of the current preset (1 - 100, P1 - P28)

Top text line: name of the preset

Bottom text line: selected amp type

PRESET: It lights up when the amp is in the standard display mode. The bar below PRESET illuminates when you edit a preset's settings.

INS-FX: It lights up if one of the PRE effects is activated for this preset. If you elect to use a wah-wah, the bar below INS-FX lights up as soon as the wah-wah is activated via the connected pedal. The bar lights up in the usual manner for the remaining PRE effects.

DELAY: It lights up when one of the delay effects is activated in the preset. If you choose to patch in the effect via the PRE circuit, the bar below DELAY lights up.

MOD FX: It lights up when one of the modulation effects is activated in the preset. If you choose to patch in the effect via the PRE circuit, the bar below MOD FX lights up.

REVERB: It lights up when one of the reverb effects is activated in the preset. If you choose to patch in the effect via the PRE circuit, the bar below REVERB lights up.

When you edit one of the preset's parameters, say **BASS**, you will see the word BASS displayed in the lower text line and the value indicated in the large numerical display. The bar below PRESET will light up.



Note: To reset the amp to standard display mode after you've edited a parameter, simply double-click **TUNER**. Or you can wait five seconds or so for the **zenTera** to take a time out and automatically reset to standard display mode.

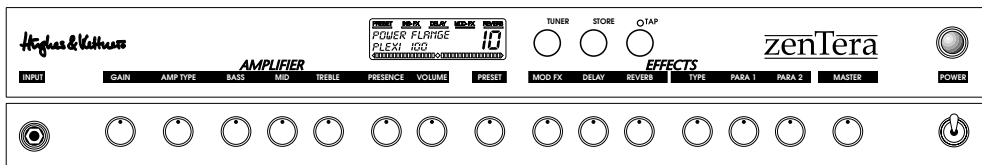

5.3 JACKS AND CONTROL FEATURES IN DETAIL

FRONT PANEL

INPUT: Connect your electric guitar or pick-up-equipped acoustic guitar to this input (it accepts all input levels).

GAIN : This knob serves different purposes depending on the selected amp type: Some of the original models (BLACK FACE, TWEED DELUXE) don't come with a master volume. For this breed of amp, GAIN responds just like a regular volume knob. For models that are equipped with both gain and master knob, the GAIN knob serves the same purpose as the gain knob on the original.

AMP TYPE: This knob carries out four functions.

- Turn the knob to select the desired amp type.
- Tap it to activate PRE EFFECT MODE (for more info, check out section 6.1, PRE EFFECT MODE). This mode puts different distortion, wah-wah and compressor effects at your disposal. Unlike the other effects found in the effect section, the only signal routing option for these effects is PRE, in other words, in front of the input.
- Press and hold to set PRE EFFECT MODE to BYPASS.
- Lots of amps are equipped with jacks offering high and low input sensitivity. On the zenTera®, you can switch between the two options by means of an analog stage located in front of the input transformer. A double-click selects HI input sensitivity, another double click selects LOW input sensitivity.



The two options yield very different sonic results. Experiment to find out which option works best for the given application, guitar etc. If your axe is equipped with powerful pick-ups, LOW will certainly be your better bet.

TONE CONTROLS : BASS, MID, TREBLE and PRESENCE knobs. These knobs work like those on the original amp and their response depends on the amp type that you have selected. Since some of the original amps don't have a presence knob or a 3-band EQ, the zenTera®'s knobs are assigned special functions to replicate all of the originals' tweaking options (for an in-depth explanation of this, see 3.0 AMP MODELS).

VOLUME : Controls preset volume. Unlike the setting of the power amp MASTER knob located on the far right, you can store this parameter. This is a handy feature because it lets you dial in the desired balance of the relative levels for all presets.

PRESET: This knob performs two functions.

- Turn the knob to select from among the 128 possible presets. The presets are activated immediately as soon as you dial them in, meaning that you don't have to confirm your selection. Memory slots 1 to 100 are designed to accommodate user presets. Slots 101 (P1) to 128 (P28) are factory presets that you can copy but not overwrite.
- Press and hold the knob to switch the GLOBAL EQ ON or OFF. (for more info, see 6.2, GLOBAL EQ).

MOD FX, DELAY and REVERB:

Each of these knobs can perform three functions:

- Turn the knob to activate the respective effect block and control the volume of the effect that you want to mix to the dry signal. (To learn more about selecting an effect, see the following section under TYPE and the tables in the appendix depicted under 11.1).

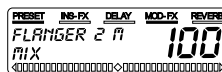

- Tap it to activate the respective effect block without changing the effect volume setting. This is a handy option when you just want to check the effect settings or edit parameters other than its volume.
- Press and hold it to bypass the given effect. This lets you A/B the sound with and without effect. Tap it again to reactivate the effect. **Note: The effect is also switched to bypass when you turn MOD FX, DELAY or REVERB to the far left position.**



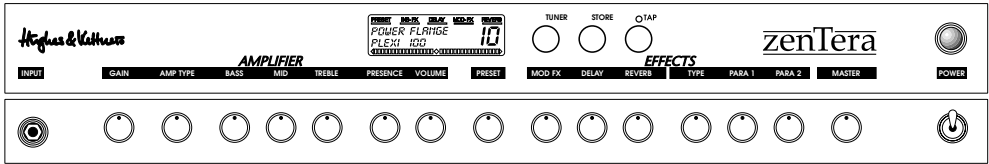

TYPE: This knob lets you dial in an effect (a chorus, a flanger and so forth). It actually serves two purposes:

- Turn the knob to select from among the different modulation, delay and reverb effects depending on which effect block is currently active (to find out which effects you have available, check out the following example table and the tables in the appendix under 11.1).



Note: The **TYPE** knob will only respond when an effect block has been activated. For more on this, see **MOD FX**, **DELAY**, **REVERB** above.

- ✔ Tap it to select the PRE signal routing option, which is akin to plugging a stomp box into the front panel input. The display indicates that this option has been selected when the bar located below **DELAY**, **MOD FX** or **REVERB** lights up. Tap it again to switch the effect to POST, in other words, in front of the power amp and therefore generally in stereo. The bar will disappear from the display. The two options yield very different sonic results. A pre effect runs through all amp sectors while a post effect is inserted very near the end of the signal chain. Here too you should experiment to find out which signal routing configuration works best for which situation.

MOD-FX
MOD-FX

Example table featuring modulation effects.

TYPE	PARAM 1	PARAM 2
Chorus Mono	Rate 0.1 - 10.0	Depth 0 - 100
Chorus Stereo	Rate 0.1 - 10.0	Depth 0 - 100
Flanger 1 Mono	Rate 0.1 - 10.0	Intensity 0 - 100
Flanger 1 Stereo	Rate 0.1 - 10.0	Intensity 0 - 100
Flanger 2 Mono	Rate 0.0 - 10.0	Intensity 0 - 100
Flanger 2 Stereo	Rate 0.0 - 10.0	Intensity 0 - 100
Phaser	Rate 0.1 - 10.0	Colour 0 - 100
Phaser XL	Rate 0.1 - 10.0	Colour 0 - 100
Tremolo	Rate 0.5 - 10.0	Shape 0 - 100

PARAM 1 and PARAM 2: These also serve two purposes

- Turn the knob to edit the parameters of the selected effect. To learn more about editing an effect, see the table above and the tables in the appendix depicted under 11.1.

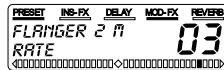

- ✔ Tap it to load the current value of the parameter into the display without changing it.
- ✔ PARAM 2 also serves another purpose: A standard sustain pedal for switching presets may be connected to the zenTera (see also Rear Panel Connections, FOOTSWITCH). To be able to switch back and forth between two presets, you must first mark one of the presets. To do this, simply double click **PARAM 2**. To learn more about this, read section 6.5, FOOTSWITCH.

MASTER ➤: It controls the level of the power amp. This knob is global, meaning that it affects all presets. Its setting cannot be stored.

TUNER: It performs three functions:

- ✔ Tap it to activate the built-in tuning device. You'll find a detailed description of this function under 6.3, TUNER.
- ✔ Press and hold it to access the system menu (see 7.0).
- ✔ You can tap TUNER once or twice (depending on the currently active mode) to exit all functions and menus and return to standard display mode.

STORE: It saves preset settings (see 6.4, STORE).

TAP: This button lets you manually sync the delay effect up to the tempo of a song. Simply tap in the desired speed. The zenTera gauges the time between taps and synchronizes the delay accordingly. TAP will of course only work when a delay effect is active. (To learn how to activate it, see MOD FX, DELAY, REVERB above.)

Beyond that, the TAP function lets you record short guitar patterns (e.g. rhythmic sequences) that the zenTera will play back in repetitive loops, which you can then solo over or use to create interlocking grooves. You'll out more about this sampling option under 6.6, TAP.

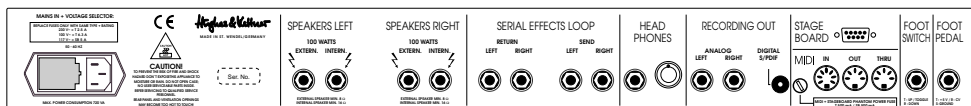

REAR PANEL

MAINS IN: Connect the factory-included mains cord to this socket. Ensure the amp's voltage rating matches your local AC voltage rating before you plug the cord into the wall socket (see 11.3). The mains fuse bracket is located next to this the socket. When replacing blown fuses, make sure you use specified replacement fuses only (see 10. TECHNICAL SPECIFICATIONS).

SPEAKER LEFT/RIGHT: The zenTera® is equipped with stereo outputs for the internal loudspeakers as well as for the connection of extension cabinets. When you opt to connect external cabinets, make absolutely sure that the overall impedance does not fall below the minimum permissible impedance of 6 ohms per channel. This means that you can connect, for example, a cabinet with at least 8 ohms in addition to the internal loudspeaker.

The following table indicates the possible speaker connection options for each channel:

Jack 1	Jack 2
Internal 16 ohms	-
Internal 16 ohms	External 16 ohms
Internal 16 ohms	External 8 ohms
External 16 ohms	-
-	External 8 ohms
External 16 ohms	External 16 ohms
External 16 ohms	External 8 ohms

Note: Read section 7.2, MODE, to find out how to adjust the zenTera® to the given speaker configuration.

EFFECTS LOOP: Serial stereo/stereo insert for connecting external effect devices. In the signal chain, the EFFECTS LOOP is located after the D/A converter and in front of the power amp volume knob.

Note: Bear in mind that the overall sound quality depends to a considerable degree on the quality of the external effect device since the entire signal is routed through it in series.

- **SEND:** Connect this output to the input of your effect device. In view of the fact that they route out signals without speaker simulation, the SEND jacks may also be used as a line out for connecting external power amps.
- **RETURN:** Connect the output of your effects device to this jack. You can also use the RETURN jacks to connect an external signal source such as an audio playback device. However, keep in mind that in this case the zenTera®'s signal is muted, which means that if you patch in an external signal here, you can't play along with it over the zenTera®.

HEADPHONES: Connect headphones to this jack. You can control the volume of the headphones output separately. Like the RECORDING OUT, this circuit features speaker simulation that replicates the sound and setup of the original amp.

Note that the internal loudspeakers are not disconnected automatically when you plug in headphones. If you want to mute the zenTera®'s speakers, turn the MASTER volume knob all the way down.

RECORDING OUT: Analog and digital stereo output for connecting the zenTera® to a mixing console or a PC.

Note: The EFFECTS LOOP is not routed to the RECORDING OUT.

- **ANALOG LEFT/RIGHT:** Patches out the RECORDING OUT signal at line level with integrated simulation of the original amps' speakers.
- **DIGITAL S/PDIF:** The digital version of the RECORDING OUT (24 bits; 44.1 kHz sampling rate).

STAGE BOARD: 9-pin port designed to take the optional Hughes & Kettner Z-Board or the optional FS-5, a 5-way foot switch.

Note: This is not an interface for connecting a PC.

MIDI IN/OUT/THRU: Standard MIDI trio. Connect a standard MIDI board here. It also serves as the interface for loading software updates and creating preset backups. The IN port is powered via a phantom power circuit equipped with a discrete fuse.

Pin function

-
- 1: MIDI Out + (current source)
 - 2: n.c.
 - 3: MIDI Out - (current sink)
 - 4: MIDI In + (current source)
 - 5: MIDI In - (current sink)
 - 6: Phantom Power + (approx. 11 V DC/ max. 600 mA)
 - 7: Phantom Power -

FOOTSWITCH: Stereo jack for connecting a 1-way or 2-way sustain pedal. It lets you switch to the next higher preset number (UP) or next lower preset (DOWN) or also back and forth between two presets (TOGGLE). For the latter alternative, you have to assign a marker to one of the two presets (see 6.5. FOOTSWITCH). Go to the system menu (see 7.12, FOOTSWITCH ASSIGN) to select the desired UP/DOWN/TOGGLE function.

Note: The zenTera® detects the polarity (1-way or 2-way) of the connected sustain pedal when it is switched on.

FOOT PEDAL: Stereo jack designed to take an expression pedal such as a volume or wah-wah pedal. The volume function is the default setting unless you assigned a wah-wah effect for the given preset in PRE EFFECT MODE. (see 6.1, PRE EFFECT MODE).

6.0 SPECIAL FUNCTIONS

6.1 PRE EFFECT MODE

The following effects are available to you in this mode (see also the table INS-FX in the appendix under 11.1). Unlike the other effects found in the effect section, the only signal routing option for these effects is PRE. In other words, in front of the input:

Wah Wah: '60s vintage wah-wah

Wah Wah 2: contemporary wah-wah with more bottom end

Fix Wah: both wah-wahs with fixed frequency (as if you left the wah-wah pedal on in a certain position)

Mod Wah: automatic version of the two wah-wahs

Compressor: three compressors with different attack times - short, medium, long

Tube Scream, Fuzz: two legendary distortion boxes

Tap **AMP TYPE** briefly to access PRE EFFECT MODE.

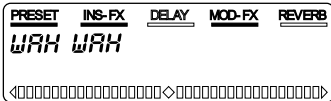

In PRE EFFECT MODE, select the desired effect via **TYPE**. Use **PARA 1** and **PARA 2** to edit the given effect parameters. Press and hold **AMP TYPE** to set PRE EFFECT MODE to BYPASS This lets you A/B the sound with and without effect.

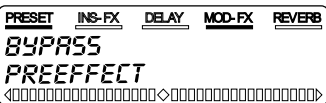

If you want to use an expression pedal (see FOOTPEDAL in the section above) to create wah-wah effects, you must use **TYPE** to assign WAH or WAH 2 to the given presets.

6.2 GLOBAL EQ

If you use your zenTera® in different venues, you may occasionally find it necessary to adjust its settings to suit the acoustics of the given room, for example, to cut back the bass frequencies for smaller clubs' stages. The GLOBAL EQ lets you do this quickly without having to adjust the settings of all presets.

To activate the GLOBAL EQ, press and hold the **PRESET** knob. EQUALIZER ON or OFF will appear in the display. If OFF appears, press and hold **PRESET** once more.



The EQ will activate and the BASS, MID, TREBLE and PRESENCE knobs are enabled.

BASS adjusts the bottom end, **MID** the low mids, **TREBLE** the upper mids, and **PRESENCE** the top end frequencies. You can switch the EQ (**PRESET**) on and off to hear how the modifications affect the sound. Once you are satisfied, leave the EQ on and exit the menu by briefly tapping **TUNER**.

Note: If the GLOBAL EQ was on when you switched the amp off, the amp will indicate this when you switch it on again. EQUALIZER ON will flash in the display for about eight seconds. The idea here is of course to remind you that the EQ is still enabled. If you are in a different venue, you should switch the GLOBAL EQ off or readjust it.

6.3 TUNER

Activate the built-in tuning device by tapping **TUNER** with your fingertip. The term TUNER will appear in the first line of the display. A large "+" appears when the string's pitch is sharp (too high), a "-" when the pitch is flat (too low), and "OK" when the string is tuned to pitch. You can also see this indicated in the chain of lights at the bottom of the display.

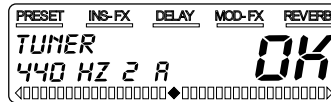

Various values can appear in the second line.

Let's take a look at these:

- 1) The selected center frequency of the reference note A is indicated at the beginning of the line. You can adjust it within a range of 435 to 445 hertz using PARA 1. This lets you calibrate the TUNER should the need arise.
- 2) You can opt to mute the zenTera while you are tuning. Use PARA 2 to preset the amp's level for the duration of the tuning procedure: M = muted, 1, 2, 3 = three different levels. The given setting appears in the display following the center frequency.
- 3) The pitch of the most recently played string is indicated at the end of the second display line.

6.4 STORE (NAME):

Press **STORE** to save preset settings.
The indicator in the display will flash.

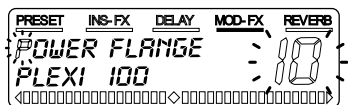

Then select the desired memory slot for the preset by means of the **PRESET** knob.

In order to name the preset, use **PARA 1** to move the cursor and select the desired letters, numbers or symbols from the available font. If you tap **PARA 2** once you have made your selection, the cursor will automatically jump to the next position, sparing you the necessity of having to navigate with **PARA 1**. The preset is stored by pressing **STORE** repeatedly.

You can cancel the storage process at any time by pressing **TUNER** or **TAP**.

Note 1: Solely the PRESET and PARA knobs are enabled during the storage process. All other knobs are disabled.

Note 2: If you want to edit and store presets you must deactivate the „MEMORY PROTECTION“ in the system menu. See 7.1 below.

6.5 FOOTSWITCH

You can connect a standard 1-way or 2-way sustain pedal to the zenTera® and use it to switch to the next higher preset number (UP) or next lower preset (DOWN), or back and forth between two presets (TOGGLE). Go to the system menu to assign the desired UP/DOWN/TOGGLE function (see 7.12, FOOTSWITCH ASSIGN).

The zenTera® detects the type of connected switch.

In order to be able to switch back and forth between two presets with a 1-way or 2-way sustain pedal, you have to select the appropriate setting in the system menu and you must assign a marker to one of the two presets. To this end, select the desired **PRESET** and double-click **PARA 2**. This sets the marker. Select the second **PRESET**. You can then switch back and forth via sustain pedal between this most recently selected preset and the preset that you assigned the marker to. This is a convenient option when just two sounds will suffice, say when you're rehearsing one song.

6.6 TAP

In addition to letting you sync up delay to the tempo of a song manually (see 5.3, TAP), the TAP button gives you another option: you can use it to create short samples of guitar patterns or riffs. The zenTera® plays these samples back in repetitive loops so that you can play a melody or another riff over them.

The optionally available Stageboard is far better suited for this purpose than the TAP button on the amp, because you have to press and hold the latter while you're recording samples. Using the Stageboard frees up both hands, which tends to make playing somewhat easier for most of us.

To sample a riff, proceed as follows:

- Tap the **DELAY** knob. You have just set the amp to DELAY mode.
- Then select one of the "HOLD" delay effects by turning the **TYPE** knob (see the table below).

If you want your sample to repeat at an unvarying volume level, set **FEEDBACK** to 100 via **PARA 2**. At values lower than 100, the volume of the sample becomes softer with every repetition.

Press and hold the TAP button while you record your sample. When you release the button, the zenTera® will generate a loop that is played back repeatedly.

DELAY

TYPE	PARA 1	PARA 2
Hold Echo	>>PLEASE USE TAP BUTTON<<	Feedback 0 - 100
Hold Ping Pong		Feedback 0 - 100
Hold Tape		Feedback 0 - 100

7.0 THE SYSTEM MENU

As its name would indicate, the system menu lets you edit basic system settings. For example, you can use it to set the zenTera® to stereo or mono mode, calibrate your foot pedal and assign MIDI functions.

To access the system menu, press and hold the **TUNER** button. Access the submenu by turning the **TYPE** knob. Use **PARA 1** and **PARA 2** to edit the given settings.

Caution! You don't need to confirm any changes, they take effect immediately!

You can quit the system menu at any time by tapping **TUNER**.

7.1 MEMORY PROTECTION

If you want to protect your user presets (1 - 100) against unintentional overwriting, you can enable memory protection in this menu. Note that if you choose to do so, you must also disable it before you can edit your presets.

Turn **TYPE** until MEMORY PROTECTION appears in the display. Use the **PARA 1** or **PARA 2** knob to now activate (ON) or deactivate (OFF) memory protection.

7.2 MODE

This feature lets you adapt the zenTera® to a 2 x 12" or a 4x 12" loudspeaker configuration. The first option is designed for the zenTera's internal speakers, the latter option is designed specifically for connecting an additional 4 x 12" cabinet. Note that this circuit was fine-tuned using the Hughes & Kettner CC 412 as the reference cabinet. This means that you'll achieve the best sonic results using this model of cabinet.

Beyond that, for both loudspeaker configurations you can determine if the output signal is sent to the power amp and the Recording Out Stereo or Mono circuits.

Turn **TYPE** until MODE appears in the display. Use **PARA 1** or **PARA 2** to select MONO 2 x 12 or STEREO 2x 12", or MONO 4 x 12" or STEREO 4 x 12".

7.3 WAKE UP

When you power the zenTera® up, it will come on line in one of two modes that you can determine.

- 1) Either it activates with the preset that was active before you last shut it down.
- 2) Or it activates with the settings that were active before you switched it off.

The difference is that in the first scenario any settings that you made but did not store are reset. This means that the preset reports back in its original stored state. In the latter case, these modifications are retained. This is an important distinction to make, particularly in live situations when you have tweaked your sound on stage to suit the venue. When you opt for the latter, the

sound that you had been using would be available again without having to dial it in again in the event of a power outage or similar mishap.

You can choose the preferred alternative in the system menu of the **zenTera**[®].

Turn the **TYPE** knob until WAKE UP appears in the display. Use the **PARA 1** / **PARA 2** knobs to set either LAST PRESET or LAST SETTING.

7.4 READ VALUES

If you want the amp to display the parameters of a preset as they were when it was originally created so that you can view them, use **TYPE** to dial up this menu. This is a special feature designed specifically to display all of a preset's settings. This spares you the hassle of checking out each parameter individually via its respective knob and prevents you from unintentionally editing these settings. You can call up all settings one after another via **PARA 1** or **PARA 2**. They are displayed in the following sequence:

• Preset Name	• Instx Para1	• Delfx Para1
• Amp Type	• Instx Para2	• Delfx Para2
• Sensitivity	• Modfx Name	• Delay Pre bzw. Delay Post
• Gain	• Modfx Mix	• Rev Name
• Bass	• Modfx Para1	• Revfx Mix
• Mid	• Modfx Para2	• Rev Para1
• Treble	• Modfx Pre bzw. Modfx Post	• Rev Para2
• Presence	• Delfx Name	• Reverb Pre bzw. Reverb Post
• Volume	• Delfx Mix	
• Instx Name		

7.5 MIDI SETUP BASE CHANNEL

Here you can define the MIDI base channel over which the **zenTera**[®] communicates. Turn **TYPE** until MIDI SETUP BASE CHANNEL appears in the display. Use the **PARA 1** / **PARA 2** knobs to set the desired channel (1-16).

7.6 MIDI PROGCHG

This submenu determines if and how the **zenTera** sends MIDI program change messages (these are commands that change presets remotely via MIDI) and how it responds when it receives these messages.

Turn **TYPE** until MIDI PROGCHG appears in the display. Using **PARA 1** or **PARA 2**, select the desired mode from the following options:

PROGCHG OFF: The **zenTera** does not send MIDI program changes, nor does it respond to incoming messages. For example, this option does not allow you to address an external effect device via MIDI, and you cannot use a MIDI switcher to change the **zenTera**'s presets.

PROGCHG ONLY: This is the default in Software 2.0. The **zenTera** sends and processes MIDI program changes. Note that messages are sent without bank select commands because these are irrelevant (for the time being, that is). More on this in the next section.

PROGCHG CC00 and CC32: MIDI program changes are sent with bank select commands. Though this option is unnecessary at this point, it will become very useful if and when a future software upgrade provides the **zenTera** with over 128 memory slots.

7.7 MIDI SETUP DEVICE ID

You may at some point elect to connect several **zenTera**'s in a MIDI chain and need to address these individually via MIDI SysEx commands. The MIDI device ID rather than the MIDI base channel is used for this purpose. To this end, select the menu via **TYPE** and choose a device ID between 1 and 127 (default value = 1) using **PARA 1** or **PARA 2**.

7.8 MIDI SYSEX SEND

This menu lets you determine if the **zenTera**[®] responds to MIDI requests by sending SysEx data (for example, presets and system settings). Turn **TYPE** until MIDI SYSEX SEND appears in the display. Then enter YES or NO via the **PARA 1** or **PARA 2** knobs.

7.9 MIDI SYSEX RECEIVE

This submenu lets you set the **zenTera**[®] so that it is able to Receive SysEx data. Turn **TYPE** until MIDI SYSEX RECEIVE appears in the display. Then enter YES or NO via the **PARA 1** or **PARA 2** knobs.

7.10 MIDI DUMP

This menu lets you create backups of your settings on an external storage medium such as your PC. This comes in handy if, for example, you play in several bands. With this option, you can download the presets that you need for each band from your archive whenever you need them. Beyond that, you can swap presets with other **zenTera**[®] users via MIDI DUMP. And this of course affords you data protection in the unlikely event that your **zenTera**[®] has to go in for repairs and you want to use a backup amp.

Connect your **zenTera**[®]'s MIDI OUT port with the MIDI IN port of your PC or another **zenTera**[®].

Turn **TYPE** until MIDI DUMP appears in the display. Use **PARA 1** or **PARA 2** to select the MIDI data that you want the **zenTera**[®] to send:

For the record, ACTIVE PRESET sends the currently active preset, ALL PRESET sends all presets. SYSTEM CONFIG sends the system menu's settings, MIDI MAP sends the data contained in the MIDI MAPPING menu (see section 7.11), and ALL sends all stored data. Send data by tapping **PARA 1**.

SYSEX SEND must be set to YES to ensure data is transferred correctly. If your **zenTera** is receiving data from another **zenTera**[®], a PC or similar device, MIDI SYSEX RECEIVE must be set to YES. You can also of course request the **zenTera**'s settings via MIDI (REQUEST; see the appendix).

To ensure flawless uploading, MIDI SYSEX SEND must be set to YES. If you want to download data from another **zenTera**[®], a PC or similar device, make sure that you set MIDI SYSEX RECEIVE to YES. You can of course request the **zenTera**'s settings via MIDI (REQUEST; see appendix for details).

7.11 MIDI MAPPING

If you employ a MIDI foot controller, use this menu to determine which of the **zenTera**'s presets are switched through program change messages sent from the foot controller. This is a particularly handy option when you want to the switch an external signal processor's effect programs at the same time via MIDI.

Use **TYPE** to dial in the MIDI MAPPING menu. Tap **PARA 1** or **PARA 2** to switch the function ON or OFF. Turn **PARA 1** to dial in one of the program numbers of your MIDI foot controller. Turn **PARA 2** to assign to this memory slot one of the **zenTera**'s 128 presets.

7.12 FOOTSWITCH ASSIGN

Using a standard 1-way or 2-way sustain pedal, you can switch presets upwards (UP) or downwards (DOWN), or you can switch back and forth between two presets (TOGGLE). This menu lets you select the desired UP/DOWN/TGL function.

Turn **TYPE** until FOOTSWITCH ASSIGN appears in the display. Select UP, DWN or TGL using the **PARA 1** or **PARA 2** knobs. If you opt for the TOGGLE function, see section 6.5 above for further instructions.

7.13 VOLUME PEDAL

This menu lets you determine at which point in the signal chain a connected volume pedal or the volume pedal of the optionally available Z-Board regulates the amp's level.

Turn **TYPE** until VOLUME PEDAL appears in the display. Using **PARA 1** or **PARA 2**, select the desired mode from the following options:

AMP VOLUME: With this option, the pedal controls the amp section's Volume knob, meaning that it adjusts the pre-effect section volume level. The volume value programmed in the preset has priority when you change a preset, and it is activated first. The level will not change until you operate the pedal.

GLOBAL: With this option, the pedal controls the amp's Master knob, meaning that it adjusts the overall output level. Even if you change a preset, the level is still determined by the pedal, or more accurately, its current value.

7.14 VOLUME PEDAL RANGE MINIMUM, VOLUME PEDAL RANGE MAXIMUM

If you have connected an expression pedal to the jack on the rear panel of the **zenTera**, you can define the desired volume control range for the pedal in these submenus. The same of course holds true for the volume pedal on the optionally available Stageboard.

Turn **TYPE** until the appropriate menu appears in the display. Select values between 0.0 and 9.9 using the **PARA 1** or **PARA 2** knobs.

7.15 CV PED TYPE

This menu lets you select a linear or a logarithmic action for your foot pedal's control range (linear = uniformly increasing volume, logarithmic = at first a steep and then a flatter rise in the volume curve).

Turn **TYPE** until CV PED TYPE appears in the display. Select LINEAR TYPE or LOG TYPE using **PARA 1** or **PARA 2**.

7.16 CV PED CALIB MIN/MAX

You can calibrate a connected expression pedal here. Turn **TYPE** until the CV PED CALIB SET TO MIN menu appears in the display. Set your foot pedal so that it rests at its minimum position (MIN, with the heel all the way back and the toe pointing up) and confirm by tapping **PARA 1** or **PARA 2**. The display automatically pages to the next menu, CV PED CALIB SET TO MAX. Floor the pedal so that it rests at its maximum position and tap **PARA 1** again. Your pedal is now calibrated and ready to "rock".

7.17 Z-BOARD BANK CHANGE

This menu lets you define how the **zenTera** responds to bank change commands sent from the Z-Board. This command can either access a preset of the next bank directly, meaning that the preset is activated immediately along with the bank change. Note that in this case the Z-Board switches in increments of five. This means that if you are currently using preset 23, a bank change command automatically activates preset 28. If you do not want presets to be switched in this manner, you can opt for pure bank change functionality. In this case, the next bank is always called up without accessing a preset directly. You then have to activate one of this bank's presets separately by stepping on the appropriate switch on the Z-Board.

Turn **TYPE** until the menu appears in the display. Use **PARA 1** to select DIR for the former, BNK for the latter option.

Note: For an in-depth explanation of the workings of the Z-Board, please consult the Z-Board owner's manual.

7.18 Z-BOARD CALIB

As described above in section 7.16 for a connected expression pedal, you can also calibrate the optional Z-Board.

Proceed as follows:

Turn **TYPE** until the Z-BOARD CALIB SET WAH MIN menu appears in the display. Set the wah-wah pedal of the Z-Board so that it rests at its minimum position (with the heel all the way back and the toe pointing up) and confirm by tapping **PARA 1** or **PARA 2**. The display automatically pages to the next menu, SET WAH MAX. Floor the pedal so that it rests at its maximum position and tap **PARA 1** again.

The display automatically pages to the next menu, SET VOLUME MIN, which lets you calibrate the volume pedal. The procedure is the same as for calibrating the wah-wah pedal. Set the volume pedal so that it rests at its minimum position and confirm by tapping **PARA 1** or **PARA 2**. The display automatically pages to the next menu, SET VOLUME MAX. Floor the pedal so that it rests at its maximum position and tap **PARA 1** again.

7.19 VERSION

This menu tells you which software versions the individual modules of your **zenTera** are running.

Turn **TYPE** until the menu appears in the display. Then you can call up the versions with **PARA 1** or **PARA 2**.

8.0 MAINTENANCE AND CARE

The **zenTera** does not require service of any type. There are however a few basic rules that will extend the service life of your amp enormously:

- Make sure all peripheral devices, cords and cables are in a state of good repair! Defective speaker cables are the most common cause of power amp failure. Poor-quality cables will cause hum and undesirable noise.
- Ensure plenty of air can circulate around your amp's ventilation ducts at all times.
- Definitely avoid exposure to mechanical shocks and extreme heat, dust and particularly moisture.
- Be picky about the kind of peripheral devices you connect to your amp and always check out their specs before you plug them in. Never connect speaker cabinets with an ohm rating lower than the **zenTera** is designed to handle. Under no circumstances should you connect devices with high output signal levels (e.g. power amps) to your amp's input.
- Be sure the AC power source delivers the current that your amp is designed to handle before you plug it in. When in doubt about the local rating, ask the venue's sound technician or a stage hand.
- Refrain from DIY repairs! To be on the safe side, you should also have a qualified technician replace internal fuses.

9.0 POSSIBLE ERROR SOURCES/ TROUBLESHOOTING

E1) The zenTera won't power up when you switch it on:

- It's not getting AC power. Check the mains cable to see if it is connected properly!
- The mains fuse is defective. Replace the fuse with another identical fuse. If this fuse also blows, be sure to talk to your local Hughes & Kettner dealer.

E2) The zenTera® is cabled up and connected properly, but no sound is audible.

- One or more of the volume knobs or the master knob is/are turned all the way down. Dial in higher settings.
- The internal speakers are not connected. Plug them in.
- The zenTera® is in TUNER mode, which means that it is muted. Quit TUNER mode by tapping the **TUNER** button.
- A shorted external speaker cable caused one of the internal fuses to blow. Have a qualified technician change the fuse (ensure the replacement fuse bears the proper rating).
- The volume pedal of the connected Z-Board is set to the minimum position. Floor the pedal.

E3) The zenTera® will not respond to the Z-Board or footswitch.

- The connector of the Z-Board or footswitch is not plugged in correctly or at all. Plug it into the zenTera®, ensuring that it is seated firmly.

E4) The sound is totally distorted when you activate a connected effects device.

- The input of the effect device is being overdriven. If it is equipped with a level meter or other level indicator, check the signal level and back off the signal processor's input sensitivity (via a knob labeled "Input" or "Gain").

E5) The signal level drops considerably when you connect an external effects device.

- The effect device is sending the signal back at too low a level. Turn up the signal processor's output level.

E6) A connected MIDI controller is not getting operating voltage via the phantom power feed of the MIDI IN port:

- The MIDI cable is defective. Replace it with a new cable.
- The phantom power fuse tripped. Replace the blown fuse making sure that the replacement has the same specs as the original fuse.

10.0 TECHNICAL SPECIFICATIONS

PREAMP SECTION

INPUT	-10 dBV / 1 M ohms
FX RETURN L/R	0 dBV / 10 K ohms
FX SEND L/R	0 dBV / 220 ohms
RECORDING OUT L/R	0 dBV / 220 ohms

POWER AMP SECTION

OUTPUT POWER	2 x 100 watts into 6 ohms
	2 x 60 watts into 16 ohms

FREQUENCY RESPONSE 20 Hz - 20 KHz

SPEAKER OUTS

	Minimum impedance per channel:
	6 ohms (1 x 16 ohms + 1 x 8 ohms)
LOUDSPEAKER	Celestion Vintage 30, 16 ohms
HEADPHONES OUT	500 mW into 4 - 600 ohms

General Specifications

MAINS VOLTAGE	230 volts AC (European version)
	117 volts AC (North American version)
	100 volts AC (Japanese version)

MAX. POWER CONSUMP.

MAINS FUSE	708 VA
	T 2.5 A (230 V model)
	T 5 A (117 V model)
	T 6.3 A (100 V model)

EXTERNAL FUSES

INTERNAL FUSES	T 500 mA MIDI Phantom
	2 x T 5 A (power amp)
	1 x T 2.5 A (DSP)
	2 x T 500 mA (analog section)

DIMENSIONS (W X H X D)

WEIGHT	750 x 585 x 300 mm
	30 kg

11.0 APPENDIX

11.1 TABLE: EFFECTS AND EFFECT PARAMETERS

The following overview gives you a survey of all of the zenTera®'s effects and effect parameters. Note that you must first activate the appropriate effect menu before you can enter and edit settings. Activate INS FX by tapping the **AMP TYPE** knob and the remaining menus by turning or tapping **MOD FX, DELAY** and/or **REVERB**.

INS FX

TYPE	PARA 1	PARA 2		
------	--------	--------	--	--

Wah Wah	-	-	-	-
Wah Wah 2	-	-	-	-
Fix Wah	Frequency	0.23 - 1.55	-	-
Fix Wah 2	Frequency	0.50 - 2.21	-	-
Mod Wah	Rate	0.0 - 10.0	Intensity	0 - 100
Mod Wah 2	Rate	0.0 - 10.0	Intensity	0 - 100
Comp Short	Make Up Gain	0.0 - 15.0	Intensity	0 - 100
Comp Medium	Make Up Gain	0.0 - 15.0	Intensity	0 - 100
Comp Long	Make Up Gain	0.0 - 15.0	Intensity	0 - 100
Tube Scream	Gain	0.0 - 10.0	Level	0.0 - 10.0
Fuzz	Gain	0.0 - 10.0	Level	0.0 - 10.0

MOD FX

TYPE	PARA 1	PARA 2		
------	--------	--------	--	--

Chorus Mono	Rate	0.1 - 10.0	Depth	0 - 100
Chorus Stereo	Rate	0.1 - 10.0	Depth	0 - 100
Flanger 1 Mono	Rate	0.1 - 10.0	Intensity	0 - 100
Flanger 1 Stereo	Rate	0.1 - 10.0	Intensity	0 - 100
Flanger 2 Mono	Rate	0.0 - 10.0	Intensity	0 - 100
Flanger 2 Stereo	Rate	0.0 - 10.0	Intensity	0 - 100
Phaser	Rate	0.1 - 10.0	Colour	0 - 100
Phaser XL	Rate	0.1 - 10.0	Colour	0 - 100
Tremolo	Rate	0.5 - 10.0	Shape	0 - 100

DELAY

TYPE	PARA 1	PARA 2		
------	--------	--------	--	--

Echo	Time	10 ms - 2 s	Feedback	0 - 100
Ping Pong	Time	10 ms - 2 s	Feedback	0 - 100
Tape Echo	Time	10 ms - 2 s	Feedback	0 - 100
Tape Halo	Time	10 ms - 2 s	Feedback	0 - 100
Tape Multi	Time	10 ms - 2 s	Feedback	0 - 100
Hold Echo	>>PLEASE USE TAP BUTTON<<		Feedback	0 - 100
Hold Ping Pong	>>PLEASE USE TAP BUTTON<<		Feedback	0 - 100
Hold Tape	>>PLEASE USE TAP BUTTON<<		Feedback	0 - 100

REVERB

TYPE	PARA 1	PARA 2		
------	--------	--------	--	--

Hall	Time	0.0 - 15.0	Predelay	0 - 100
Spring	Time	0.0 - 15.0	Predelay	0 - 100
Garage	Time	0.00 - 5.00	Predelay	0 - 100
Stage	Time	0.0 - 15.0	Predelay	0 - 100
Small	Time	0.00 - 5.00	Predelay	0 - 100
Bright	Time	0.0 - 15.0	Predelay	0 - 100
Normal	Time	0.0 - 15.0	Predelay	0 - 100
Warm	Time	0.0 - 15.0	Predelay	0 - 100

11.2 MIDI IMPLEMENTATION CHART

MIDI Implementation Chart v. 2.0 (page 1 of 3)				
Manufacturer: Hughes & Kettner		Model: Zentera	Version: 2.01 Date: 05.12.00/AP	
		Transmitted	Recognized	Remarks
1. Basic Information				
MIDI channels		1-16	1-16	
Note Numbers		-	-	
Program Change		Yes ¹⁾	Yes	¹⁾ Adjustable via System Menu
Bank Select Response? (Yes / No)				
If yes, list banks utilized in remarks column				
Modes supported:	Mode 1:Omni-On, Poly (Yes/No) Mode 2:Omni-On, Mono (Yes/No) Mode 3:Omni-Off, Poly (Yes/No) Mode 4:Omni-Off, Mono (Yes/No) Multi Mode (Yes/No)			Mode 3 / 4: Omni Off
Note-On Velocity (Yes/No)		No	No	
Note-Off Velocity (Yes/No)		No	No	
Channel Aftertouch (Yes/No)		No	No	
Poly (Key) Aftertouch (Yes/No)		No	No	
Pitch Bend (Yes/No)		No	No	
Active Sensing (Yes / No)		No	No	
System Reset (Yes / No)		No	No	
Tune Request (Yes / No)		No	No	
System Exclusive:	Sample Dump Standard (Yes/No) Device Inquiry (Yes/No) File Dump (Yes/No) MIDI Tuning (Yes/No) Master Volume (Yes/No) Notation Information (Yes/No) Turn GM1 System On (Yes/No) Turn GM2 System On (Yes/No) Turn GM System On (Yes/No) Other (note in Remarks column)	No No No No No No No No No Yes	No No No No No No No No No Yes	Data Dumps for User Preset Data, Global Data, Firmware Update MIDI Program Change Map Factory Preset Data
NRPNs (Yes/No)		No	No	
RPN 00 (Pitch Bend Sensitivity) (Yes / No)		No	No	
RPN 01 (Channel Fine Tune) (Yes/No)		No	No	
RPN 02 (Channel Coarse Tune) (Yes/No)		No	No	
RPN 03 (Tuning Program Select) (Yes/No)		No	No	
RPN 04 (Tuning Bank Select) (Yes/No)		No	No	
RPN 05 (Modulation Depth Range) (Yes/No)		No	No	
2. MIDI Timing and Synchronisation				
MIDI Clock (Yes/No)		No	No	
Song Position Pointer (Yes/No)		No	No	
Song Select (Yes/No)		No	No	
Start (Yes/No)		No	No	
Continue (Yes/No)		No	No	
Stop (Yes/No)		No	No	
MIDI Time Code (Yes/No)		No	No	
MIDI Machine Control (Yes/No)		No	No	
MIDI Show Control (Level/No)		No	No	
3. Extensions Compatibility				
General MIDI compatible? (Level(s)/No)			No	
Is GM default power-up mode? (Level/No)				
DLS compatible (Level(s)/No)			No	
Import DLS Files? (Type(s)/No)				
Export DLS Files? (Type(s)/No)				
Import Standard MIDI Files (Type(s)/No)			No	
Export Standard MIDI Files (Type(s)/No)				
NOTES				

MIDI Implementation Chart v. 2.0 (page 2 of 3)

Manufacturer: Hughes & Kettner		Model: Zentera	Version: 2.01	Date: 05.12.00/AP
Controller #	Function	Transmitted (Y/N)	Recognized (Y/N)	Remarks
0	Bank Select (MSB)	Yes	Yes	
1	Modulation Wheel (MSB)	No	No	
2	Breath Controller (MSB)	No	No	
3				
4	Foot Controller (MSB)	No	No	
5	Portamento Time (MSB)	No	No	
6	Data Entry (MSB)	No	No	
7	Channel Volume (MSB)	No	No	
8	Balance (MSB)	No	No	
9				
10	Pan (MSB)	No	No	
11	Expression (MSB)	No	No	
12	Effect Control 1 (MSB)	No	No	
13	Effect Control 2 (MSB)	No	No	
14				
15				
16	General Purpose Controller 1 (MSB)	No	No	
17	General Purpose Controller 2 (MSB)	No	No	
18	General Purpose Controller 3 (MSB)	No	No	
19	General Purpose Controller 4 (MSB)	No	No	
20				
21				
22				
23				
24				
25				
26				
27				
28				
29				
30				
31				
32	Bank Select (LSB)	Yes	Yes	
33	Modulation Wheel (LSB)	No	No	
34	Breath Controller (LSB)	No	No	
35				
36	Foot Controller (LSB)	No	No	
37	Portamento Time (LSB)	No	No	
38	Data Entry (LSB)	No	No	
39	Channel Volume (LSB)	No	No	
40	Balance (LSB)	No	No	
41				
42	Pan (LSB)	No	No	
43	Expression (LSB)	No	No	
44	Effect Control 1 (LSB)	No	No	
45	Effect Control 2 (LSB)	No	No	
46				
47				
48	General Purpose Controller 1 (LSB)	No	No	
49	General Purpose Controller 2 (LSB)	No	No	
50	General Purpose Controller 3 (LSB)	No	No	
51	General Purpose Controller 4 (LSB)	No	No	
52				
53				
54				
55				
56				
57				
58				
59				
60				
61				
62				
63				

MIDI Implementation Chart v. 2.0 (page 3 of 3)

Manufacturer: Hughes & Kettner		Model: Zentera		Version: 2.01	Date: 05.12.00/AP
Controller #	Function	Transmitted (Y/N)	Recognized (Y/N)	Remarks	
64	Sustain Pedal	No	No		
65	Portamento On/Off	No	No		
66	Sostenuto	No	No		
67	Soft Pedal	No	No		
68	Legato Footswitch	No	No		
69	Hold 2	No	No		
70	Sound Controller 1 Sound Variation	No	No		
71	Sound Controller 2 Timbre	No	No		
72	Sound Controller 3 Release Time	No	No		
73	Sound Controller 4 Attack Time	No	No		
74	Sound Controller 5 Brightness	No	No		
75	Sound Controller 6 Decay Time	No	No		
76	Sound Controller 7 Vibrato Rate	No	No		
77	Sound Controller 8 Vibrato Depth	No	No		
78	Sound Controller 9 Vibrato Delay	No	No		
79	Sound Controller 10	No	No		
80	General Purpose Controller 5	No	No		
81	General Purpose Controller 6	No	No		
82	General Purpose Controller 7)	No	No		
83	General Purpose Controller 8	No	No		
84	Portamento Control	No	No		
85					
86					
87					
88					
89					
90					
91	Effects 1 Depth Reverb Send Level	No	No		
92	Effects 2 Depth	No	No		
93	Effects 3 Depth Chorus Send Level	No	No		
94	Effects 4 Depth	No	No		
95	Effects 5 Depth	No	No		
96	Data Increment	No	No		
97	Data Decrement	No	No		
98	Non-Registered Parameter N. (LSB)	No	No		
99	Non-Registered Parameter N. (MSB)	No	No		
100	Registered Parameter Number (LSB)	No	No		
101	Registered Parameter Number (MSB)	No	No		
102					
103					
104					
105					
106					
107					
108					
109					
110					
111					
112					
113					
114					
115					
116					
117					
118					
119					
Channel Mode Messages					
120	All Sound Off	No	No		
121	Reset All Controllers	No	No		
122	Local Control On/Off	No	No		
123	All Notes Off	No	No		
124	Omni Mode Off	No	No		
125	Omni Mode On	No	No		
126	Poly Mode Off	No	No		
127	Poly Mode On	No	No		

11.3 AC POWER AND THE GLOBAL CURRENT ADAPTER

NOTE: Before plugging into the wall socket, make certain the amp is set to the proper voltage for your locale. You can read the amp's voltage setting in the Voltage Selector window found on the back of the unit. Also check the fuse specifications printed above the amp's power cord socket, and ensure that the fuses you are using have the correct value for your local current.

zentera® can operate at AC currents of 230 volts, 117 volts or 100 volts. Use the VOLTAGE SELECTOR to adjust the voltage accordingly (see Diagram 1):

- Press the fuse's safety latch (1) towards the window (3) with a small screwdriver and remove it with the two fuses.
- Pull the cartridge (4) out of its socket.
- Rotate the cartridge (4) and plug it back into the socket so the desired voltage is legible.
- Replace the previously mounted fuses (5). Make certain the values of your fuses are identical to those required for your local voltage. The values are specified above the amp's power cord socket.
- Reinsert the fuse cartridge (2) with the new fuses (5).
- Before you plug into the wall socket, check again to ensure the correct voltage rating is legible in the VOLTAGE SELECTOR window (3).

11.3 NETZANSCHLUSS UND WELTSPANNUNGSADAPTION

HINWEIS: Stellen Sie bitte vor dem Anschluß des zentera® sicher, daß die vorhandene Netzspannung mit dem im Sichtfenster des VOLTAGE SELECTORS angegebenen Spannungswert übereinstimmt. Überprüfen Sie auch die Sicherungswerte entsprechend dem Aufdruck nahe der Anschlußbuchse.

Der zentera® kann an den Netzspannungen 230 V, 117 V und 100 V betrieben werden. Die Anpassung erfolgt mittels des in die Netzbuchse integrierten VOLTAGE SELECTORS. Dazu wird wie folgt vorgegangen (siehe Abb. 1):

- Mittels eines kleinen Schraubenziehers die Sperre (1) des Sicherungshalters in Richtung Sichtfenster (3) drücken und diesen zusammen mit den beiden Sicherungen herausziehen.
- Den Steckensatz (4) herausziehen.
- Der Steckensatz (4) wird so gedreht und wieder eingesteckt, daß der Aufdruck der gewünschten Netzspannung nach außen zeigt.
- Die vorher montierten Sicherungen (5) werden ersetzt. Verwende nur den nahe der Anschlußbuchse aufgedruckten Sicherungswert, der für die neue Netzspannung vorgesehen ist!
- Den Sicherungshalter (2) zusammen mit den neuen Sicherungen (5) einsetzen.
- Vor dem Netzanschluß nochmals prüfen, ob der richtige Spannungswert im Sichtfenster (3) des VOLTAGE SELECTORS erkennbar ist.

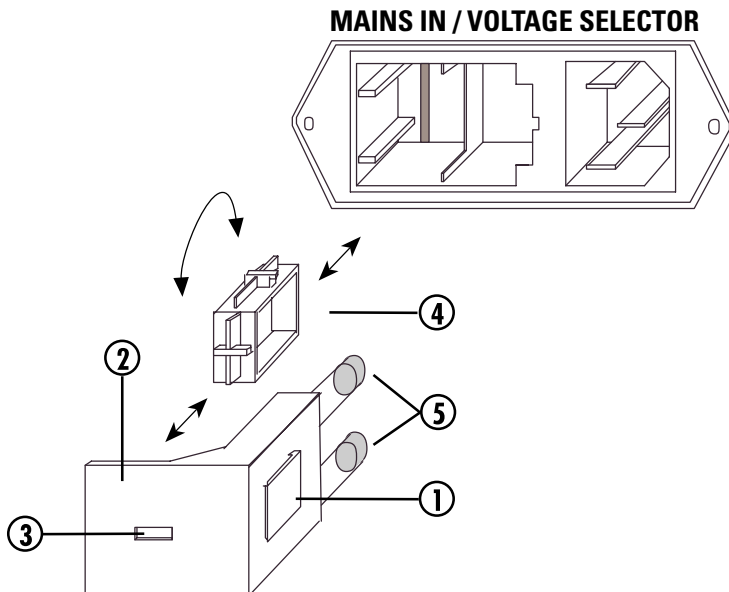

Free Manuals Download Website

<http://myh66.com>

<http://usermanuals.us>

<http://www.somanuals.com>

<http://www.4manuals.cc>

<http://www.manual-lib.com>

<http://www.404manual.com>

<http://www.luxmanual.com>

<http://aubethermostatmanual.com>

Golf course search by state

<http://golfingnear.com>

Email search by domain

<http://emailbydomain.com>

Auto manuals search

<http://auto.somanuals.com>

TV manuals search

<http://tv.somanuals.com>