

HUMAX

LAU-26TPVR

LCD Digital and Analogue TV

Digital 2 Tuner PVR Built-in



◀ LCD Digital and
Analogue TV

Caution



To reduce the risk of electric shock, do not remove cover(or back). No user serviceable parts inside. Refer servicing to qualified service personnel. Indicates a situation which, if not avoided, could damage the equipment or other apparatus.

This symbol indicates **dangerous voltage** inside the LCD-TV that presents a risk of electric shock or personal injury. Indicates a hazardous situation which, if not avoided, could result in serious injury.

This symbol indicates important instructions accompanying the LCD-TV.

Read this manual carefully and make sure you understand the instructions provided. For your safety, check what the result of each action will be. Throughout the whole manual, pay special attention to the following marks that indicate hazardous situations. Indicates additional information to the user to make the user aware of possible problems and information of any importance to help the user to understand, to use and to maintain the installation.

The information in this document is subject to change without notice.

Copyright (Copyright © 2005 HUMAX Corporation)

Not to be copied, used or translated in part or whole without **HUMAX's** prior consent in writing except approval of ownership of copyright and copyright law.

Warranty

HUMAX does not have any responsibility for direct, indirect, accidental and other damage caused by the use of the information contained in this manual.

Trademarks

VIACCESS™ is a trademark of France Telecom.

CryptoWorks(TM) is a trademark of Philips Electronics N.V.

Irdeto is a trademark of Mindport BV.

Nagravision is a registered trademark of KUDELSKI S.A.

Conax is a trademark of Telenor Conax AS.

'Dolby' and the double-D symbol are trademarks of Dolby Laboratories.

Manufactured under the license from Dolby Laboratories.



TruSurround XT is a trademark of SRS Labs, Inc.

TruSurround XT technology is incorporated under license from SRS Labs, Inc.

Thank you for purchasing a HUMAX LCD-TV. Please read this user manual carefully in order to safely install, use and maintain the LCD-TV at maximum performance. Keep this user manual next to your LCD-TV to ensure the best performance possible.

2. Caution

Safety Instructions

This **LCD-TV** has been engineered and manufactured to assure your safety. You can prevent serious electrical shock and other hazards by keeping in mind the following:

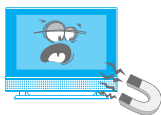

Do not place anything heavy, wet or magnetic on the LCD TV or the power cord. Never cover the ventilation openings with any material and never touch them with metallic or inflammable materials.

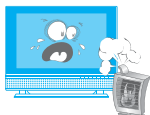

Avoid operating the LCD-TV in extreme heat, humidity or areas affected by dust.

+ Temperature : 0~50°C + Humidity : 20~90RH



Be sure to turn the LCD-TV off before plugging the power cord into the socket. Make sure that the power cord and the other cords are securely and correctly connected.

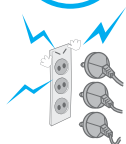

Overloaded AC outlets and extension cords are dangerous, as are frayed power cords and broken plugs, which may cause electric shock or fire. Call your service technician for replacement.



Do not use sharp tools such as a pin or a pencil near the LCD-TV, as they may scratch the LCD surface.



Do not use a solvent, such as benzene (any liquids), to clean the LCD-TV, as it will damage the LCD surface. The apparatus shall not be exposed to dripping or splashing.



Be careful when touching the LCD-TV. When you touch the LCD-TV, be careful not to get a cut on your fingers with an acrylic surface of the LCD-TV.

Warning

- 1** Follow these directions in order not to damage the power cord or plug. Do not modify the power cord or plug. Do not bend or twist the power cord too much. Make sure to disconnect the power cord using the plug rather than the power code. Keep heating appliances as far as possible from the power cord in order to prevent the cover vinyl from melting.
- 2** Follow these directions. Failure to follow one of them may cause an electrical shock. Do not open the main body. Do not insert metals or inflammable objects inside the LCD-TV. Do not touch the power plug with wet hands. Disconnect the power cord in case of lightning.
- 3** Do not use the LCD-TV when it is out of order. If you continue to use the LCD-TV when defective, serious damage can be caused to it. Make sure to contact your local LCD-TV distributor if the LCD-TV is out of order.
- 4** Please do not insert metal or alien substances into the slots for the modules and smart cards. In doing so it can cause damage to the LCD-TV and reduce its life span.
- 5 Hard Disk Drive :** Do not move the LCD-TV or turn the power off suddenly while the hard disk drive is running. The company shall not be liable for any corruption of data on the hard disk drive caused by the carelessness or misuse of users. This LCD-TV provides up to 40GB of hard disk drive. Do contact your LCD-TV provider when you change the hard disk drive.

3. Safety Instructions

Contents

Before Using the TV	Package Contents	07
	Front Panel	08
	Rear Panel	09
Setting Up the TV	Remote Control	10
	+ Main Remote Control	10
	+ Simple Remote Control	13
	+ Inserting the Batteries	14
	Mounting Device	15
	+ Assembling the Stand-Base	15
	+ Installing on the Wall	15
	Connecting the External Equipment	16
	+ Connecting the Aerial	16
	+ Connecting the PC	16
	+ Connecting the External Devices	17
+ Connecting the DVD	17	
+ Connecting the DVI	17	
Using the Analogue TV	Setting the Analogue Channels	18
	+ Setting the Analogue Channels Automatically	18
	+ Setting the Analogue Channels Manually	19
	+ Editing the Analogue Channels	20
	Basic Operation	21
	+ Powering the TV On/Off	21
	+ Changing the Input Mode	21
	+ Volume Control	21
	+ Selecting the Channel	21
	+ Choosing your Language	21
	+ Listing Channels	22
+ Using the OK Button	22	
+ Using the Audio Button	22	
+ Setting the Sleep Time	22	
Setting the Picture	23	
+ Mode	23	
+ Colour Temperature	23	
Setting the PIP/TWIN	24	
+ PIP/TWIN	24	
+ Using the PIP Buttons in the Remote Control	25	
+ Using the Digital Channels in PIP/TWIN Mode	25	
Changing the Sound	26	
+ Effect	26	
+ Auto Volume Level	26	
+ TruSurround XT	26	
+ Sound Source	26	
+ Using the Sound Button in the Remote Control	26	
Setting the Time	27	
+ Setting the Current Time	27	
+ Automatically Turning the TV On and Off	27	
Setting the System	28	
+ Language	28	
+ OSD Transparency	28	
+ AV Output	28	
+ Antenna Power	28	
+ Aspect Ratio	28	
+ Backlight Brightness	28	
Displaying the Teletext Information	29	
Setting the PC Input	30	

4. Contents - Analogue TV

Contents

Recording and Playback (PVR function)	Recording	31
	+ Instant Recording	31
	- Setting the Recording Quality	32
	- Setting the Clipping Noise Reduction	32
	+ Recording Reservation	33
	- Adding Recording Reservations	33
	- Editing Recording Reservations	34
	+ Time Shifted Recording	35
	Playback	37
	+ Programme Playback	37
	+ Editing Recorded Programmes	39
	- Editing Title	39
	- Delete File	39
	- Copy File to External Device	39
	- Connecting the External HDD	40
	+ Playback Control	41
	- Play / Pause	41
	- Rewind to Previous Scene	41
	- Fast forward to Next Scene	41
	- Recording	41
	- Direct Jump	41
	- Instant Reply	42
	- Repeat between A and B	42
	- Bookmark	42
	HDD Control	43
	+ Checking the Hard Disk Drive	43
	+ Connecting the External HDD	44

Contents

Using the Digital TV	Digital TV Channel Setup	45
	Basic Operation	46
	+ Switching Channel	46
	+ Changing the Subtitle Language	46
	+ Changing an Audio Language	46
	+ Programme Information - Information Banner (I-Plate)	47
	Channel List	49
	+ Displaying and Switching Channel List	49
	+ Editing Channels	49
	+ Editing Favourite Channels	52
	Programme Guide	53
	+ Viewing Programme Guide Information	53
	+ Finding a Programme	54
	+ Adding Reservations by Guide	55
Setting the Preferences	56	
+ Parental Control	56	
+ Local Setting	57	
+ Miscellaneous Settings	59	
Installation	60	
+ Automatic Search	60	
+ Regional Search	61	
+ Manual Search	62	
+ Default Setting	63	
System Information	64	
+ Status	64	
+ Signal Detection	64	
+ Common Interface	65	
Game	65	
Software Upgrade	66	
+ Software Update from PC	66	
Appendix	Menu Map	67
	+ LCD TV Menu	67
	+ PC Main Menu	67
	+ Digital TV Menu	68
	Troubleshooting	69
	+ Troubleshooting	69
+ Error Message	70	
Specification	72	
Glossary	73	
Service and Support	74	

Package Contents

- + Please check all package contents before using your LCD-TV.
- + Package Contents may be different according to the area.

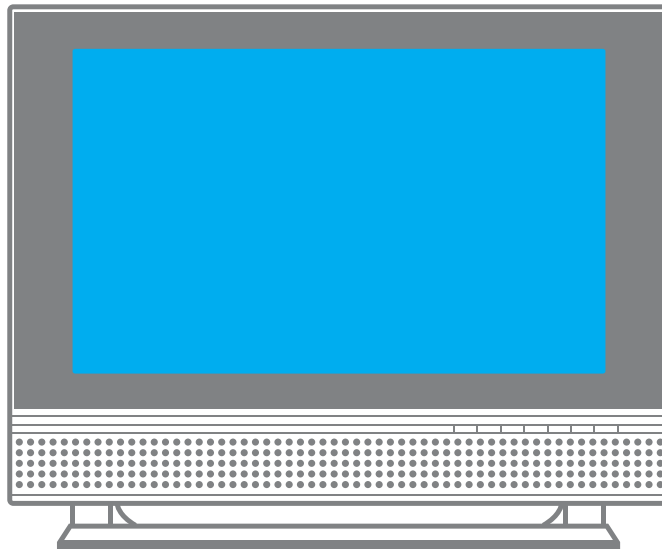

LCD - TV

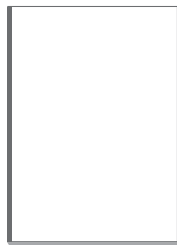

User's Manual



AAA Batteries (x2)

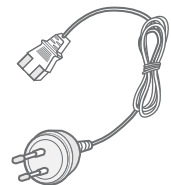

Power Cable

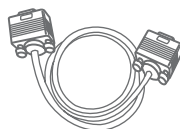

PC Cable



Simple Remote Control (SR-10)



Main Remote Control (NR-103)

7. Package Contents

Front Panel

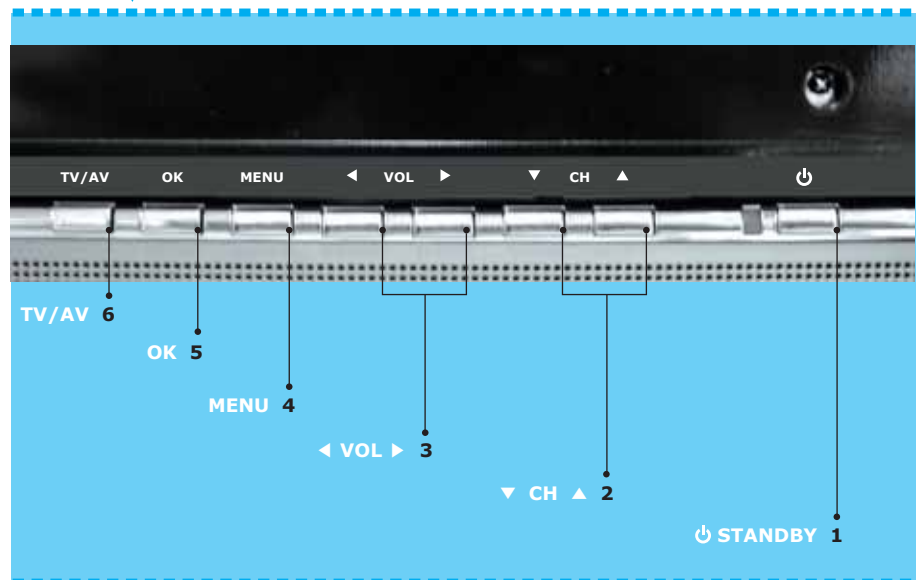
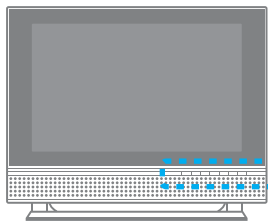

1. : STANDBY

Switches between Operation and Standby modes.
Displays Red colour when the set is in standby mode.
Changes to Green colour when the set is switched on.

2. CH

Selects a programme or a menu item.

3. VOL

Adjusts the volume. Adjusts the menu setting.

4. MENU

Displays the menu.

5. OK

Selects a menu or confirms the selected operation.

6. TV/AV

Selects the input signal (Digital TV, Analog TV, AV1, AV2, AV3, S-Video, Component, PC, DVI).

8. Front Panel

Rear Panel

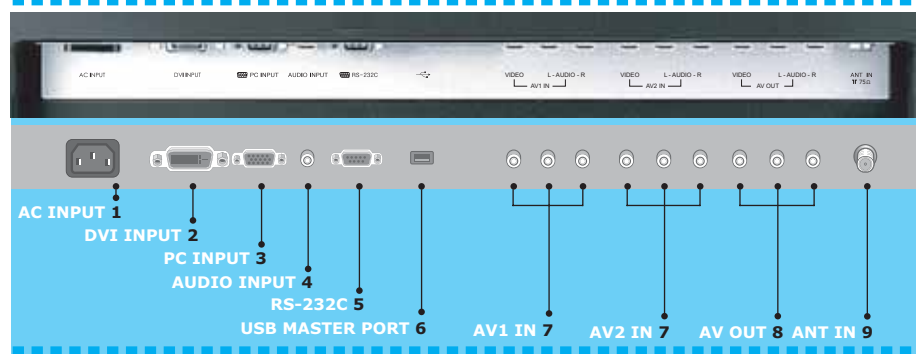
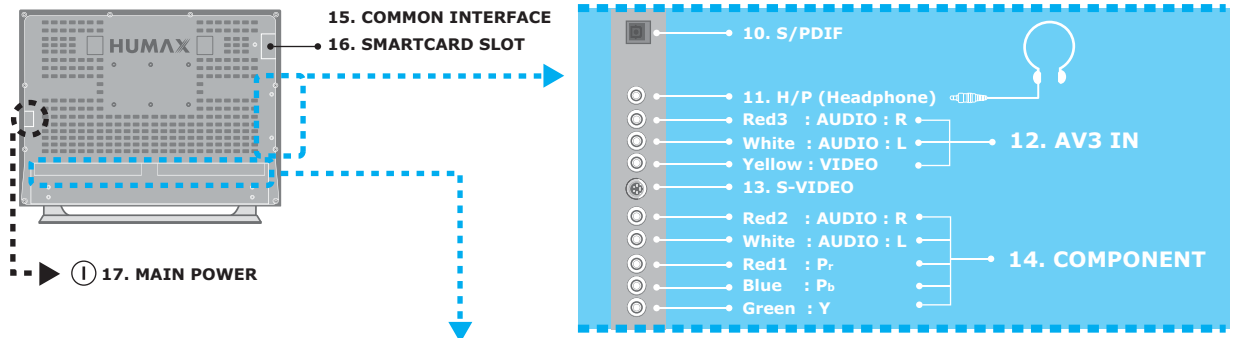

1. AC INPUT

Connect the supplied AC power cord.

2. DVI INPUT

Connect to the digital video output jack of an external device with DVI output.

3. PC INPUT

Connect to the video output jack on your PC, using the PC cable supplied.

4. AUDIO INPUT

Connect to the audio output jack on your PC or your external device with DVI output.

5. RS-232C

Connect to the RS-232C port on your PC for software upgrade.

6. USB MASTER PORT

Connect to the USB port on an external HDD for moving the various digital data to/from an external HDD.

7. AV1 IN, AV2 IN

Connect for the video and audio input to external devices with RCA cables.

8. AV-OUT

Connect for the video and audio output to external devices such as a VCR or DVD.

9. ANT IN (Antenna In)

Connect to your aerial for digital and analogue TV signal.

10. S/PDIF

Connect to Dolby digital decoder for the digital audio signal output.

11. H/P (Headphone)

Connect to your headphone.

12. AV3 IN

Connect for the video and audio input to external devices with RCA cable.

13. S-VIDEO

Connect to an external device with S-Video output.

14. COMPONENT

Connect to an external device with Component output, such as DVD.

15. COMMON INTERFACE

Use for one CA Module with a smart card.

16. SMARTCARD SLOT

Slot for Smartcard.

17. MAIN POWER

Main Power Button.

9. Rear Panel

Remote Control

All the functions can be controlled with the Remote Control handset. Some function can also be adjusted with the buttons on the front panel of the set. Both the Main Remote Control to control the all functions and the Simple Remote Control to control the some simple functions are provided. Before you use the Remote Control handset, please install the batteries.

Main Remote Control

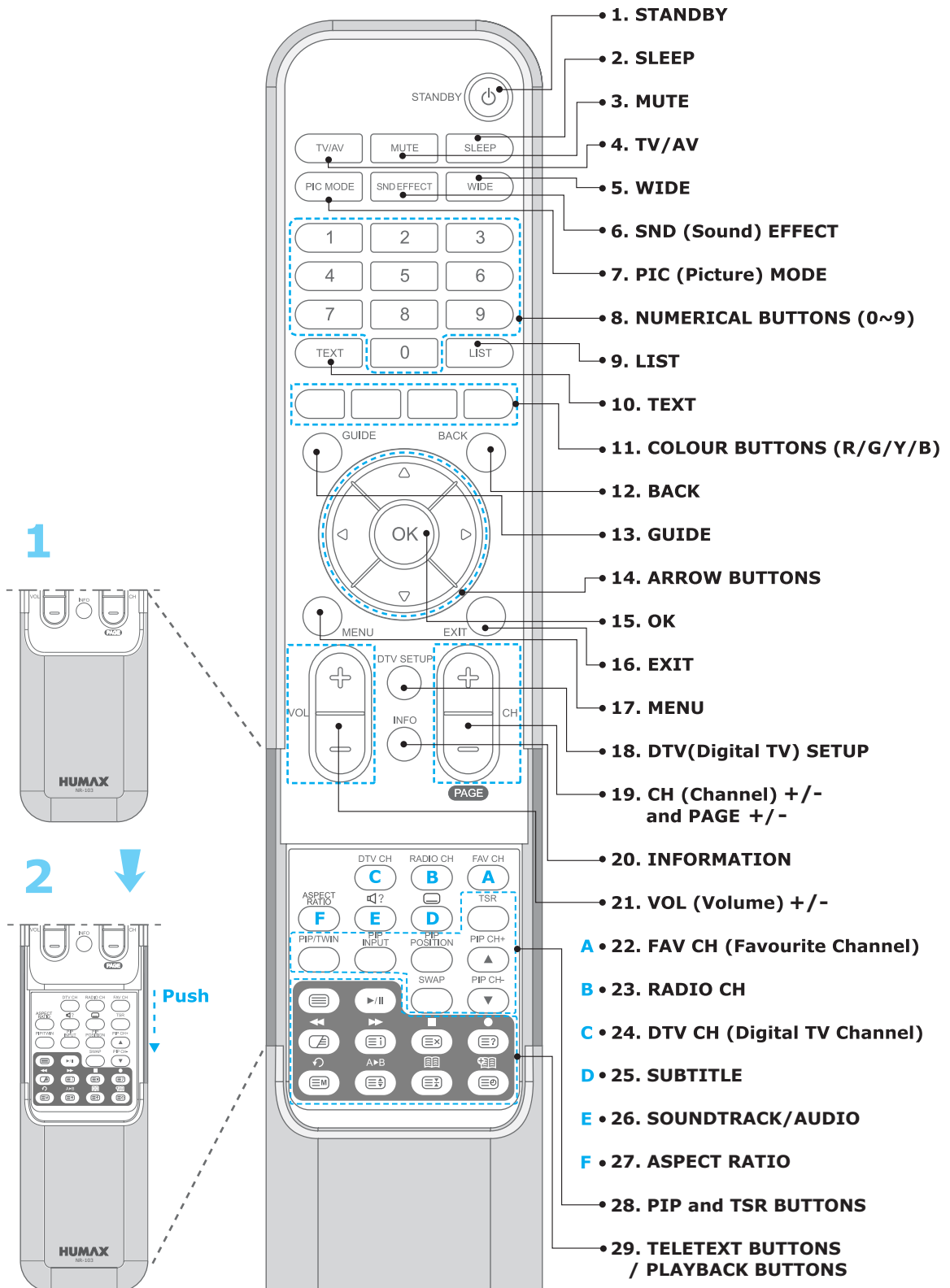

10. Remote Control

Remote Control

1. STANDBY

Switches between Operation and Standby modes.

2. SLEEP

Sets the sleep time.

3. MUTE

Mutes the audio.

4. TV/AV

Selects input signal between TV and another signals.

5. WIDE

Enlarges the picture to the wide aspect ratio in the Digital TV mode. Unavailable when PIP or TWIN mode.

6. SND (Sound) EFFECT

Changes the sound mode.

7. PIC (Picture) MODE

Changes the picture mode.

8. NUMERICAL BUTTONS (0~9)

Enters a channel number or menu option number.

9. LIST

Displays the channel list.

10. TEXT

Not used for this product.

11. COLOUR BUTTONS (R/G/Y/B)

Selects colour keys for teletext in the Analog TV and Digital TV modes.

12. BACK

Returns to the previous menu and screen.

13. GUIDE

Displays the Programme Guide.

14. ARROW BUTTONS (▲, ▼, ◀, ▶)

Moves the cursor to the up, down, left or right menu option.

15. OK

Selects a menu, or confirms the selected operation and displays the channel list whilst watching a programme.

16. EXIT

Exits the main menu or Guide screen.

17. MENU

Displays the main menu.

18. DTV Setup

Displays the DTV Setup menu in the Digital TV mode.

19. CH +/- and PAGE +/-

Changes the Channel or Page.

20. INFORMATION

Displays the information about the channel and programme in the Digital TV mode.

21. VOL +/-

Adjusts the audio volume.

A • 22. FAV CH

Displays the Favourite Channel List in the Digital TV mode.

B • 23. RADIO CH

Switches to digital Radio channel in the Digital TV mode.

C • 24. DTV CH

Switches to digital TV channel in the Digital TV mode.

D • 25. SUBTITLE

Changes the subtitle language in the Digital TV mode.

E • 26. SOUNDTRACK/AUDIO

Lists alternative soundtracks enable stereo, dual or mono sound in the Digital TV mode.

F • 27. ASPECT RATIO

Changes the aspect ratio of the screen.

Remote Control

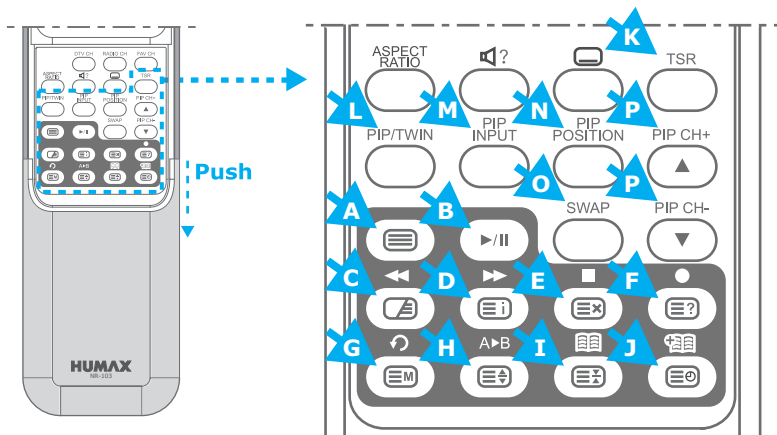

PIP AND TSR BUTTONS

K. TSR (TIME SHIFTED RECORDING)
Switches the Time Shifted Recording On and Off.

L. PIP/TWIN
Changes PIP/TWIN mode.

M. PIP INPUT
Change the PIP input mode.

N. PIP POSITION
Control the PIP position.

O. SWAP
Switch between main screen and PIP screen.

P. PIP CH +/-
Change the PIP channel.

TELETEXT BUTTONS

A. TELETEXT ([])
Activate/Deactivate the teletext service.

C. MIX ([])
Displays the teletext with the broadcasting screen.

D. INDEX ([])
Displays the teletext index page.

E. UPDATE ([])
Displays the TV picture on the screen whilst waiting for the new teletext page.

F. REVEAL ([])
Displays the concealed information.

G. MODE ([])
Programme a colour button in LIST mode.

H. SIZE ([])
Selects a text size.

I. HOLD ([])
Holds function during teletext display. Stop the automatic page change.

J. SUBPAGE ([])
Search the sub-page using the sub-code.

PLAYBACK BUTTONS (for PVR)

B. PLAY / PAUSE ([])
Plays or pause a programme.

C. FAST REWIND ([])
Rewinds a programme. Each time you press this button, the scenes is rewound more faster divided into 4 steps.

D. FAST FORWARD ([])
Fast forwards a programme. Each time you press this button, the scene is forwarded faster divided into 4 steps.

E. STOP ([])
Stops a programme.

F. RECORD ([])
Records a programme.

G. INSTANT REPLAY ([])
Replays the programme from 7 seconds previous scene.

H. A-B REPEAT ([])
Plays back a specified block repeatedly.

I. BOOKMARK LIST ([])
Displays the list of saved viewing positions.

J. ADD BOOKMARK ([])
Saves the present viewing position as a bookmark.

Remote Control

Simple Remote Control

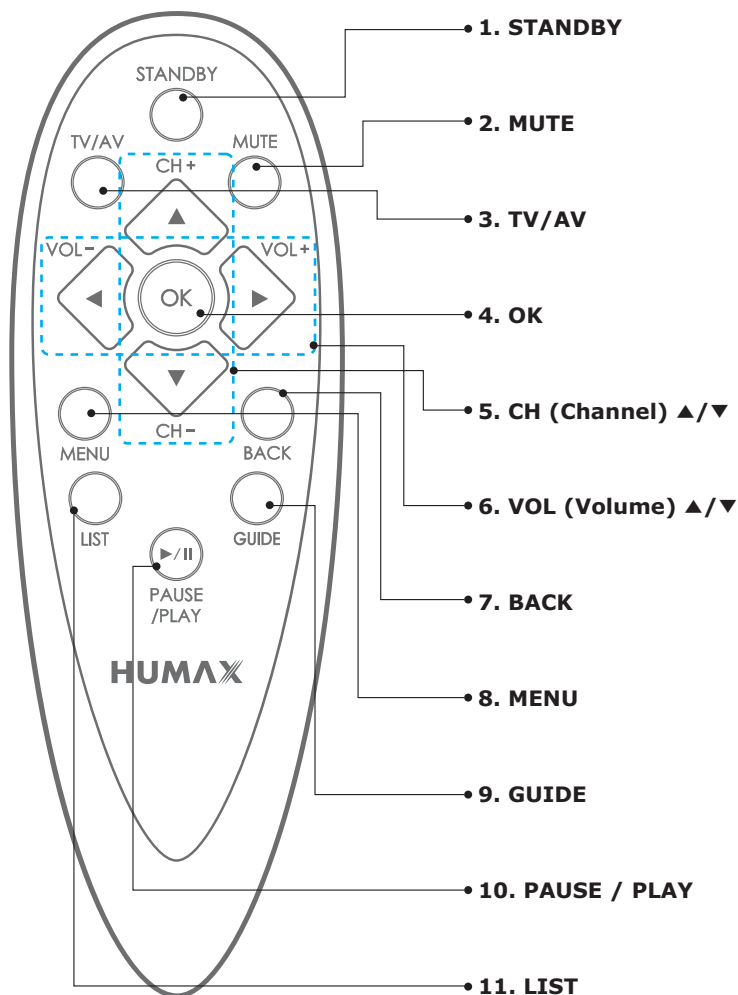

1. STANDBY

Switches between Operation and Standby modes.

2. MUTE

Mutes the audio.

3. TV/AV

Selects input signal between TV and another signals.

4. OK

Selects a menu, or confirms the selected operation and displays the channel list whilst watching a programme.

5. CH (Channel) +/-

Changes the Channel.

6. VOL (Volume) +/-

Adjusts the audio volume.

7. BACK

Returns to the previous menu and screen.

8. MENU

Displays the main menu.

9. GUIDE

Displays the Programme Guide.

10. PAUSE/PLAY

Plays or pause a programme.

11. LIST

Displays the channel list.

Remote Control

Inserting the Batteries

You must insert or replace the batteries in the remote control when you:

- + Purchase the TV.
- + Find that the remote control is no longer operating correctly.

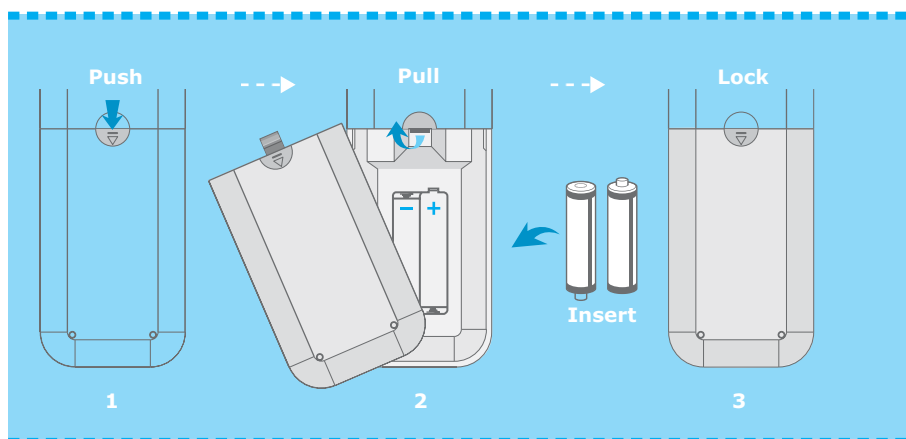

1. Pull the battery cover upward in the arrow direction to remove.
2. Insert the batteries as illustrated in the battery compartment.
3. Put the battery cover back.
4. For Simple Remote Control, insert the batteries in the same way.

- + Apply two 1.5V batteries of AAA type. Don't mix used batteries with new batteries.
- + Remove batteries when you don't use the remote control for long periods. Liquid leakage from old batteries may cause operation failure.

Notes for using remote control

- + **Make sure there are no objects between the remote control and its sensor.**
- + **Don't place the remote control near a heater or damp place. Strong impact on remote controller may cause operation failure.**
- + **The signal from the remote control may be subjected to interference from sunlight or other strong light.**

Mounting Device

This describes how to set up the LCD-TV. Select the most appropriate procedure depending on your requirements.

If you encounter any problem when setting up the LCD-TV, please contact your local LCD-TV distributor.

Assembling the Stand-Base

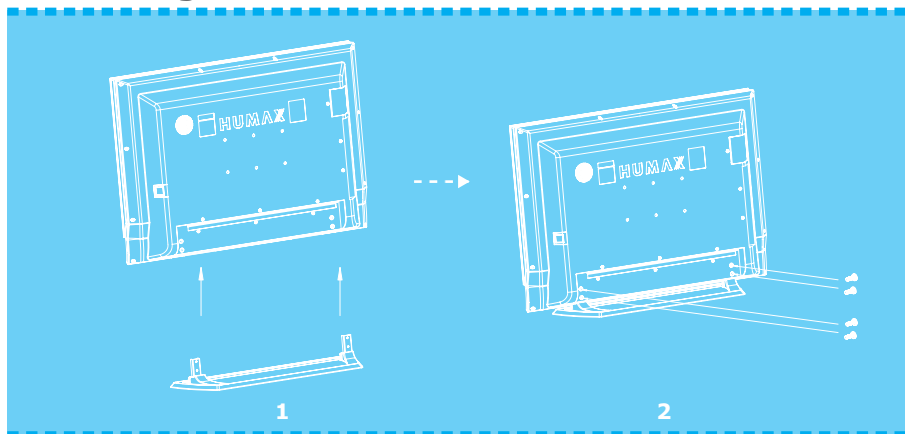

1. Attach your LCD-TV with the stand-base.
2. Firmly fix the stand-base and the LCD-TV using the 4 screws.

Note : Firmly fix the stand-base for the LCD-TV before moving it, as the stand-base may fall and could cause serious injury.

Installing on the Wall

You can install the LCD-TV on the wall using a mounting bracket (sold separately). To reduce the risk of damage from falling, this LCD-TV should be secured at all times. (The LCD TV in the picture may not look exactly like yours.)

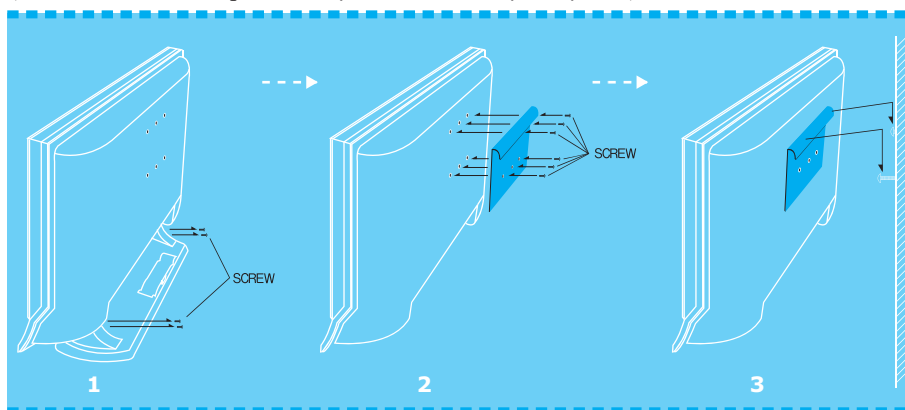

1. Before you install, separate the LCD-TV and stand-base.
2. Attach your main body bracket on the LCD-TV and fix using screws firmly.
3. Stick the LCD-TV with main body bracket into the wall bracket attached on the wall.
4. Tighten up a safety-screw.

Note :

- _ Do not install the set on a weak surface such as plaster or foam board.
- _ Be at enough distance to open CI door between the LCD-TV and the wall when installing on the wall. If the LCD-TV is not at proper distance from the wall, the CI door may be not opened enough.

15. Mounting Device

Connecting the External Equipment

You can connect additional equipment, such as **VCRs, DVD, etc.** to your set. Examples are shown below.

Connecting the Aerial

To view television channels correctly, a signal must be received by the set from one of following sources :

- + An outdoor aerial
- + An indoor aerial (not recommended)

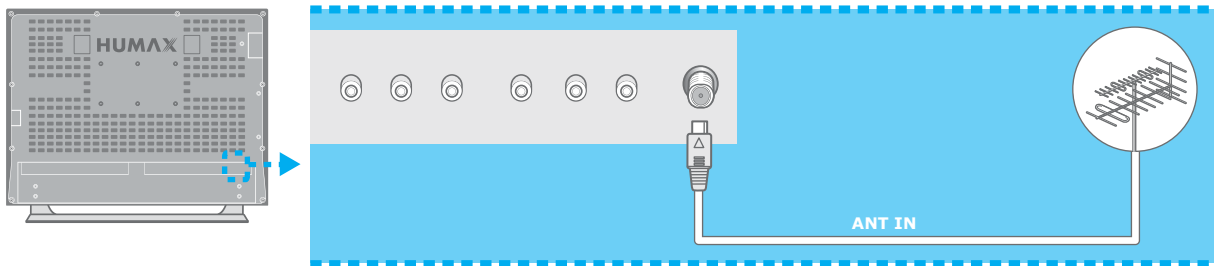

1. Connect the aerial to the **ANT IN** on the bottom of the LCD-TV.
2. Press the **TV/AV** button on the remote control.
3. Select **Analog TV** or **Digital TV**.

Connecting the PC

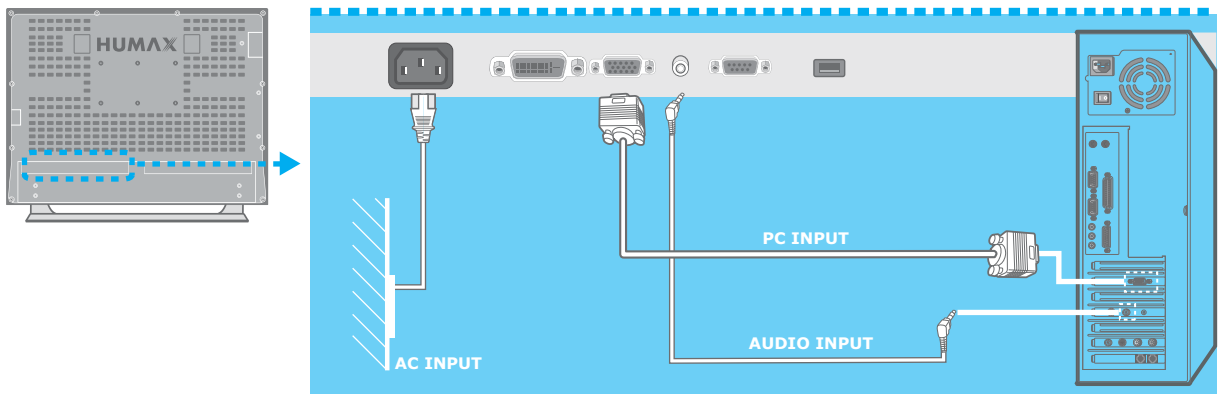

1. Turn off your computer and LCD-TV.
2. Connect a PC D-Sub cable between your PC and **PC INPUT** of the LCD-TV and then fasten the screws of both sides on the cable.
3. Connect a PC Audio Cable between the Sound Output jack of the sound card on your PC and the **AUDIO INPUT** of the LCD-TV.
4. Connect the Power cable to the **AC INPUT** jack on the rear of your LCD-TV. And connect power code to a power outlet.
5. Power on your PC before turning on the LCD-TV.

16. Connecting the External Equipment

Connecting the External Equipment

Connecting the External Devices

1. Connect video/audio RCA cable using a ferrite core as indicated in the diagram.
2. For optimal visual image, use **S-VIDEO** lead(cable not supplied).
3. If you wish to connect the optical **S/PDIF** terminal and Dolby Digital decoder to listen digital audio, connect as follows. (cable not supplied)

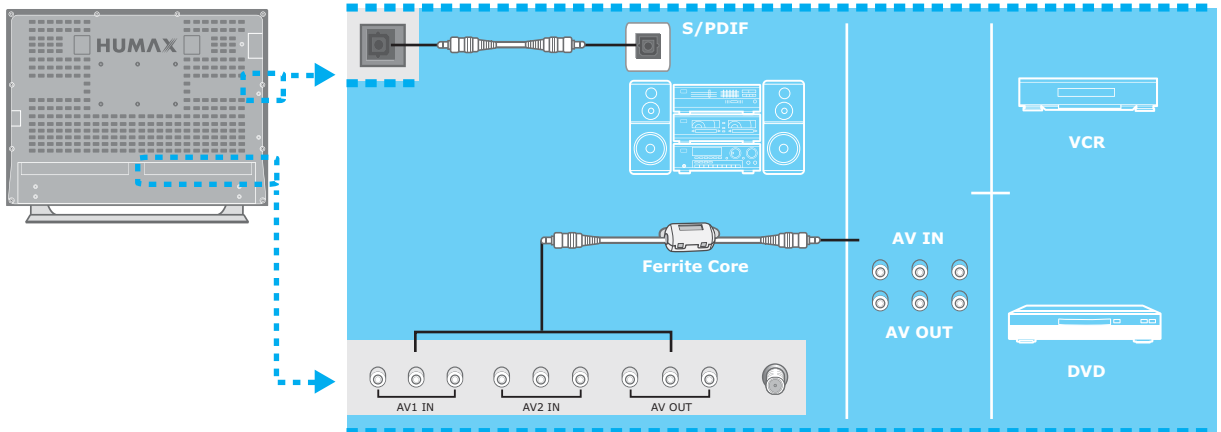

Connecting the DVD

Connect **AUDIO L/R** to **AUDIO OUT** connector of the DVD.
For viewing, use **S-Video** or **Component Video Input (Y, Pb, Pr)**.
For listening, use **Component Audio Input (Audio L/R)**.

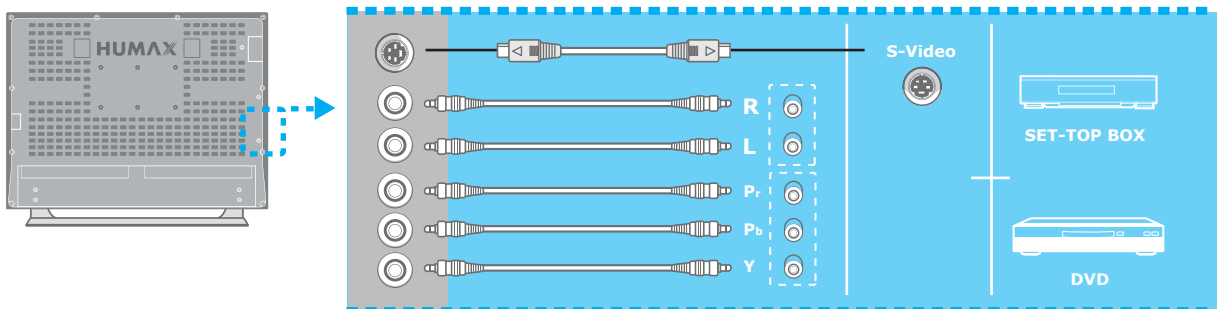

Connecting the DVI

Connect the DVI cable and Audio cable as follows.
For viewing, use **DVI INPUT**. For listening, use **AUDIO INPUT**.

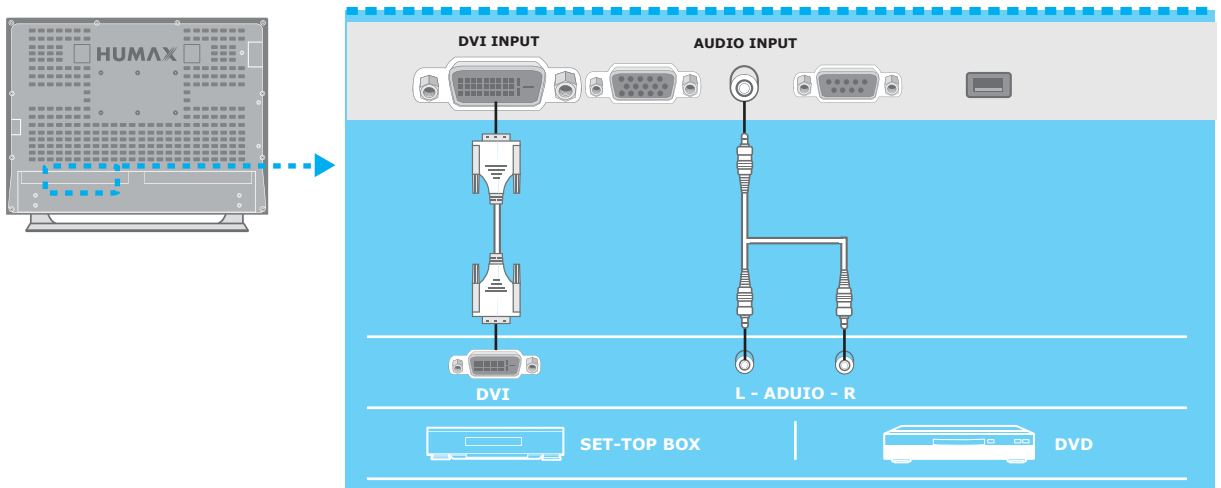

17. Connecting the External Equipment

Setting the Analogue Channels

Setting the Analogue Channels Automatically

You can scan for the frequency ranges available to you (and availability depends on your country.) Automatically allocated programme numbers may not correspond to actual or desired programme numbers. However you can sort numbers manually and clear any channels you do not wish to watch. It's only for analogue TV mode.



1. Press the **MENU** button.
2. Select **Channel** using the ▲/▼ button, and press the **OK** or ► button.
3. Select **Auto Programme** using the ▲/▼ button, and press the **OK** or ► button.
4. Select **System** using the ▲/▼ button, and press the ◀ or ► button to select a particular system.
BG : I : DK
5. Select **Storage From** using the ▲/▼ button, and press the ◀, ► or **NUMERICAL (0~9)** button to enter the starting number to store the scanned programme.
6. Select **Start Search** using the ▲/▼ button, and press the **OK** or ► button to start auto scanning. To stop the search before it has finished, press the **BACK** button.

The search will end automatically. Channels are sorted and stored in an order, and then the programme originally selected is displayed.

In the digital TV mode, you can select Setup Digital Channel menu instead of Channel menu.

Setting the Analogue Channels

Setting the Analogue Channels Manually

The Manual Programme allows you to manually tune and arrange the channels in the order you desire. You can also assign a channel name with characters to each channel number. It's only for analogue TV mode.



1. Press the **MENU** button.
2. Select **Channel** using the ▲/▼ button, and press the **OK** or ► button.
3. Select **Manual Programme** using the ▲/▼ button, and press the **OK** or ► button.
4. Select **System** using the ▲/▼ button, and press the ◀ or ► button to select a particular system.

BG : I : DK

5. Select **Band** using the ▲/▼ button, and press the ◀ or ► button to select a particular system.

V/UHF : Cable

6. If you know the channel number to be stored, select **Channel** using the ▲/▼ button, and press the ◀, ► or **NUMERICAL (0~9)** button to select number. If you do not know the channel number, select **Search** using the ▲/▼ button, and press the ◀ or ► button to start search.
7. Select **Programme No.** using the ▲/▼ button, and press the ◀, ► or **NUMERICAL (0~9)** button to assign a programme number into the channel.
8. Select **Name** using the ▲/▼ button, and press the **OK** or ► button to change a name.
To select a letter (A~Z, 0~9, +, -), press the ▲/▼ button.
To move on the previous or next letter, press the ◀ or ► button.
To store the changing name, press the **OK** button.
9. Select **Fine Tune** using the ▲/▼ button, and press the ◀ or ► button to fine-tune the channel manually. If the signal is weak or distorted, you may have to fine-tune the channel manually.
10. When you are satisfied with your choice, press the **BACK** button to store the current setting values.

Setting the Analogue Channels

Editing the Analogue Channels

This function enables you to delete, copy, move, or skip the stored channel. It's only for analogue TV mode.

1. Press the **MENU** button.
2. Select **Channel** using the **▲/▼** button, and press the **OK** or **▶** button.
3. Select **Edit Programme** using the **▲/▼** button, and press the **OK** or **▶** button. The programme list is displayed in the main screen.
4. Select the **programme name** to edit with **▲/▼/◀/▶** button and press the Colour (R/G/Y/B) buttons to delete, copy, move, or skip the programme.

+ Delete button : **RED** + Copy button : **GREEN**
+ Move button : **YELLOW** + Skip button : **BLUE**

Skipping a Channel

- _ Select a channel to skip with the **▲/▼/◀/▶** button.
- _ Press the **BLUE** button, the channel selected will change to the blue colour. Thereafter these channels will be skipped when using the **CH +/-** button.
- _ To return to normal status, select the skipped channel and then press again the **BLUE** button for 2~3 seconds.

Moving a Channel

- _ Select a channel to move with the **▲/▼/◀/▶** button.
- _ Press the **YELLOW** button to select the channel you wish to move. Use the **▲/▼/◀/▶** button to move the channel to the desired position, and then press the **YELLOW** button again to store.

Copying a Channel

- _ Select a channel to copy with the **▲/▼/◀/▶** button.
- _ Press the **GREEN** button.

Deleting a Channel

- _ Select a channel to delete with the **▲/▼/◀/▶** button.
- _ Press the **RED** button. If you press the **RED** button again, the selected channel will be deleted.

While editing the programme, you can switch to the channel you select.

Programmes		
0	\$	19
1	\$	20
2	\$	21
3	\$	22
4	\$	23
5	\$	24
6	\$	25
7	\$	26
8	\$	27
9	\$	28



Basic Operation

Powering the TV On/Off

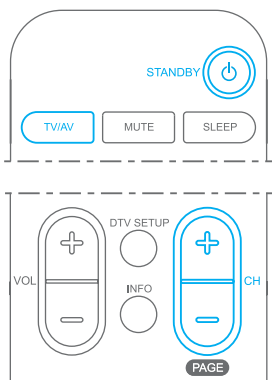

1. Connect the plug to the wall outlet.
2. Press the **MAIN POWER** button on the rear of the LCD-TV to turn the TV power on.
3. Press the **STANDBY**, **TV/AV** or **CH +/-** button on the front of the LCD-TV or press the **STANDBY**, **TV/AV**, **CH +/-** or **NUMERICAL (0~9)** buttons on the remote control to switch the TV on.

Note : To place the TV in standby mode, press the **STANDBY** button again on the remote control or on the front of the LCD-TV. It can be useful when you wish to interrupt viewing temporarily (during a meal, for example).

4. To turn the TV power off, press the **MAIN POWER** button on the rear of the LCD-TV.

Note : Do not leave the TV in standby mode for too long (on holiday, for example). Turn the TV off by pressing the **MAIN POWER** button on the rear of the LCD-TV. It is best to disconnect the power cord.

Changing the Input mode

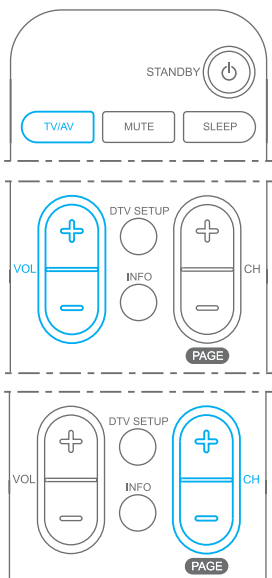

1. Press the **TV/AV** button to change the input mode.
2. Select your desired mode using the **▲/▼** button, and press the **OK** button. You can also change the input mode by pressing the **TV/AV** button repeatedly.

Volume Control

1. Press the **VOL +/-** buttons to adjust the audio volume.
2. Press the **MUTE** button to mute the sound.

Selecting the Channel

1. Press the **CH +/-** or **NUMERICAL (0~9)** buttons to change the channel number.

Choosing Your Language

When you start using your television for the first time, you must select the language which will be used for displaying menus and indications.

1. Press the **MENU** button.
2. Select **System** using the **▲/▼** button, and press the **OK** or **▶** button.
3. Select **Language** using the **▲/▼** button, and press the **◀** or **▶** button to select a particular language.
4. When you are satisfied with your choice, press the **EXIT** button to return to normal viewing.



21. Basic Operation

Basic Operation

Programmes		
0	S	19
1	S	20
2	S	21
3	S	22
4	S	23
5	S	24
6	S	25
7	S	26
8	S	27
9	S	28

Listing Channels

You can watch the programme list while watching analogue TV.

1. Press the **LIST** button.
2. Select a channel using the **▲/▼** button, and press the **OK** button to switch to the selected channel. You can also move to the next or previous list page using the **PAGE +/-** button.

Using the OK button

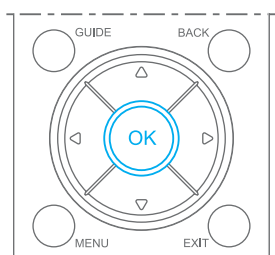

When you press the **OK** button, the information of the channel appears :

- _ Channel number, channel name, and current time in the **Analog TV** mode
- _ External input mode and current time in the **AV** input mode.
- _ The information of Main and PIP screen in the **PIP** mode.

If you wish to disappear the information, press the OK button again. In the audio mode also, the information appears.

Using the Audio button

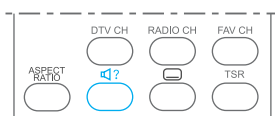

You can hear the sound with various modes. (Mono, Stereo, Dual mode)
Press the **SOUNDTRACK/AUDIO** button repeatedly to switch into other mode.

If it is not switched, it's the channel that various modes are not supplied.

Setting the Sleep Time

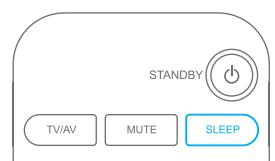

You can select a time for the TV to turn off automatically.
Press the **SLEEP** button repeatedly until the desired time appears.
The number changes from Off . 10 . 20 . 30 . 60 . 90 . 120 . 180 . 240.
When the selected time is out, the TV will turn off automatically.
To cancel the sleep time, press the **SLEEP** button repeatedly and select --- (**Sleep Off**).

Setting the Picture

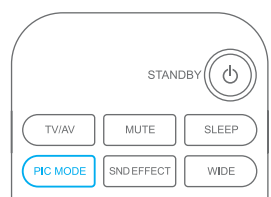
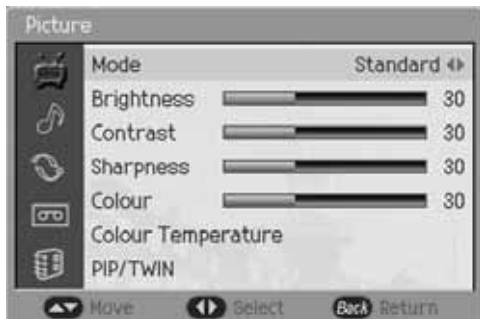

Mode

You can select the picture type you prefer.

1. Press the **MENU** button.
2. Select **Picture** using the ▲/▼ button, and press the **OK** or ► button.
3. Select **Mode** using the ▲/▼ button and press the ◀ or ► button to select a particular mode. If you select **User**, you can control the value manually.
Standard : Dynamic : Movie : Mild : User
4. On the Standard, Dynamic, Movie, or Mild, the value of the Brightness, Contrast, Sharpness and Colour is changed automatically. You can also set these options simply by pressing the **PIC MODE** (Picture Mode) button.

Item	Setting Change				
Brightness	Darker	◀	0 ~ 100	▶	Brighter
Contrast	Less	◀	0 ~ 100	▶	More
Sharpness	Less sharp	◀	0 ~ 100	▶	Shaper
Colour	Lower	◀	0 ~ 100	▶	Higher

Note : If you change the value of the Brightness, Contrast, Sharpness and Colour, the **User** is selected automatically.

Colour Temperature

You can select the picture colour tone you prefer.

1. Press the **MENU** button.
2. Select **Picture** using the ▲/▼ button, and press the **OK** or ► button.
3. Select **Colour Temperature** using the ▲/▼ button and press the **OK** or ► button.
4. Select **Colour Temp** using the ▲/▼ button, and press the ◀ or ► button to select a particular colour tone. If you select **User**, you can control the value manually.
Normal : Cool : Warm : User
5. On the Normal, Cool, or Warm, the value of the R/G/B Gain is changed automatically.

Note : If you change the value of the R/G/B Gain, the **User** is selected automatically.

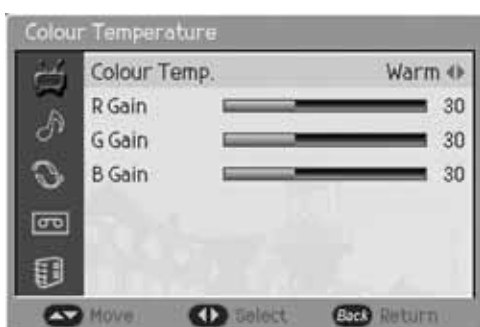

23. Setting the Picture

Setting the PIP/TWIN

PIP/TWIN

With PIP, Picture in Picture, you can call up a small screen within the main screen. This enables you to watch two different input sources at the same time. In this way, you can watch TV programme or monitor the video input from any connected devices while watching TV or other video input.

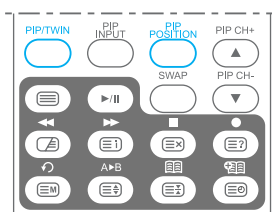
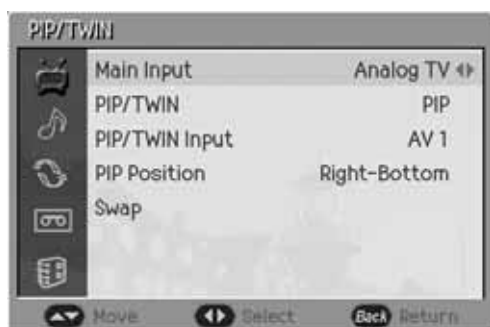

1. Press the **MENU** button.
2. Select **Picture** using the **▲/▼** button, and press the **OK** or **▶** button.
3. Select **PIP/TWIN** using the **▲/▼** button, and press the **OK** or **▶** button.

4. Select **Main Input** using the **▲/▼** button, and press the **◀** or **▶** button to select a particular thing.

Digital TV : Analog TV : AV1 : AV2 : AV3 : S-Video : Component : PC : DVI

5. Select **PIP/TWIN** using the **▲/▼** button, and press the **◀** or **▶** button to select a particular thing.

_ Off : Switch PIP mode off.

_ PIP (Picture in Picture) : Switch PIP mode on.

_ TWIN 1, TWIN 2 : Switch two Twin screen modes on.

(Twin screen 1, Twin screen 2)

6. Select **PIP/TWIN Input** using the **▲/▼** button, and press the **◀** or **▶** button to select a particular thing.

Digital TV : Analog TV : AV1 : AV2 : AV3 : S-Video : Component : PC : DVI

Note : You can only select different inputs between Main Input and PIP/TWIN Input except Digital TV mode.

You can enjoy two digital channels simultaneously in each screen.

7. Select **PIP Position** using the **▲/▼** button, and press the **◀** or **▶** button to move the PIP picture to another corner of the screen.

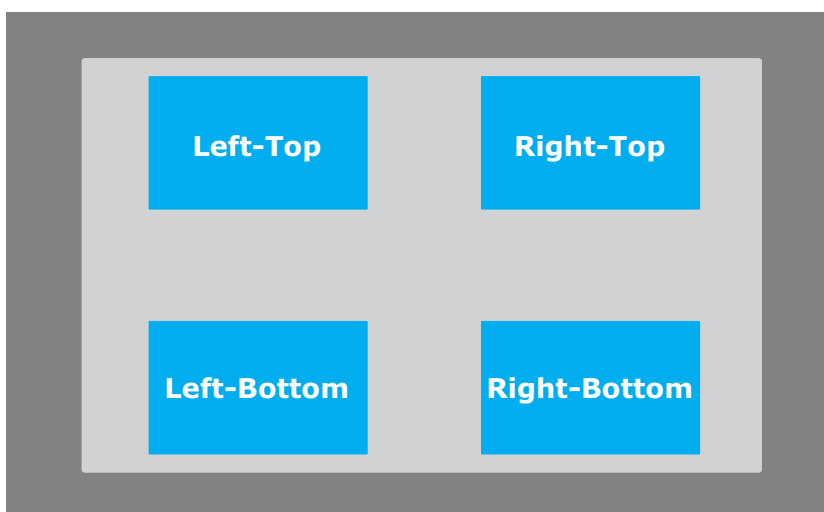

Note : If you wish to select PIP Position, you must set the PIP/TWIN mode to PIP.

24. Setting the PIP/TWIN

Setting the PIP/TWIN

8. Select **Swap** using the ▲/▼ button, and press the ► button to exchange the picture in the main screen and small screen. Not available in PC Mode.

In case of PIP

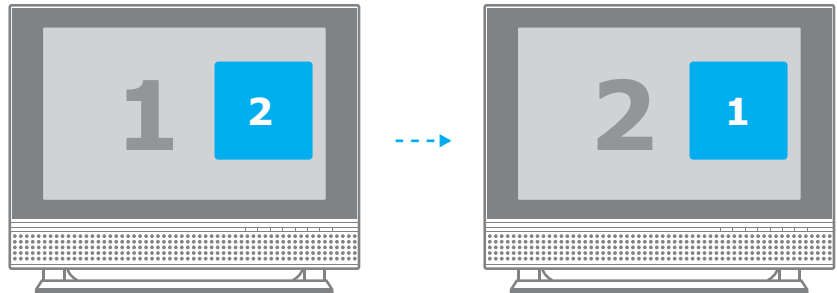

In case of TWIN1 or TWIN2

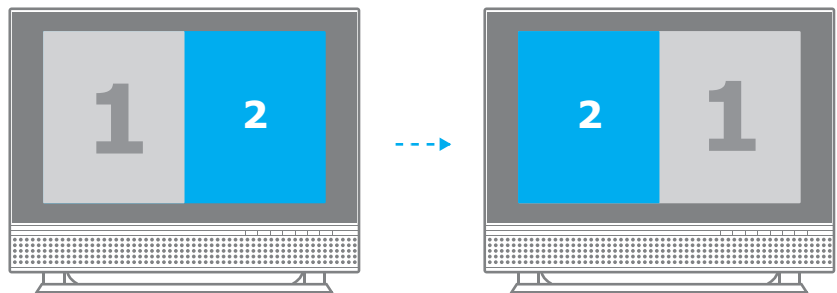

Using the PIP Buttons in the Remote Control

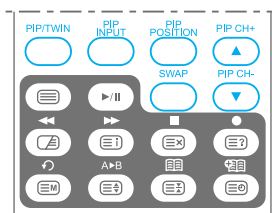

You can use the PIP buttons on the remote control. Press **PIP/TWIN** button repeatedly during watching TV channel to switch into PIP or TWIN mode. Press **PIP INPUT** button repeatedly to change the input mode in the small screen. Press **PIP POSITION** button repeatedly to move the position of the small screen. Press the **PIP CH+ / PIP CH-** button to change the TV Channels in the small screen. Press **SWAP** button to exchange the picture in the main screen and small screen.

Using the Digital Channels in PIP/TWIN Mode

You can watch two digital channels simultaneously using PIP/TWIN mode.

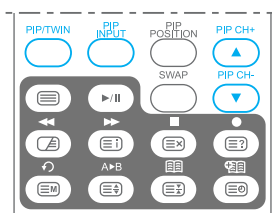

1. Press **PIP/TWIN** button during watching digital TV channel.
2. Press **PIP INPUT** button repeatedly, and change to Digital TV mode in the small screen.
3. Press **PIP CH+ / PIP CH-** to change the channel in the small screen.

Note : There are the programme which you cannot watch in the small screen such as scrambled programmes or data programmes.

25. Setting the PIP/TWIN

Changing the Sound

You can select the preferred sound settings which corresponds with the personal sound settings.

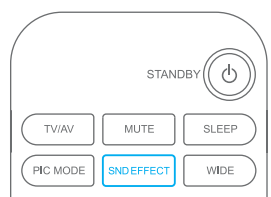
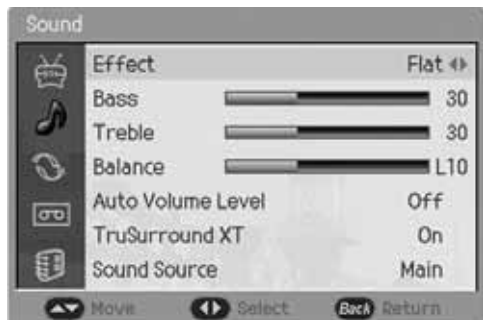

1. Press the **MENU** button.
2. Select **Sound** using the ▲/▼ button, and press the **OK** or ► button.

Effect

3. Select **Effect** using the ▲/▼ button and press the ◀ or ▶ button to select a particular thing. If you select **User**, you can control the value manually.
Flat : Speech : Movie : Music : User
4. On the Flat, Speech, Movie, or Music, the value of the Bass, Treble, and Balance is changed automatically. You can also set these options simply by pressing the **SND EFFECT** (Sound Effect) button.

Item	Setting Change
Bass	◀ 0 ▶ Adjusts low sounds
Treble	◀ 0 ▶ Adjusts high sounds
Balance	◀ 0 ▶ Adjusts left and right volumes

Note : If you change the value of the Bass, Treble, and Balance, the User is selected automatically.

Auto Volume Level

5. Select **Auto Volume Level** using the ▲/▼ button and press the ◀ or ▶ button to select **On** or **Off**.

Note : Auto Volume Level can adjust the volume every time the channel is changed.

TruSurround XT

6. Select **TruSurround XT** using the ▲/▼ button and press the ◀ or ▶ button to select **On** or **Off**.

Note : The benefits of TruSurround XT sound are enormous. You can be completely enveloped in sound: just as if you were at a concert hall or cinema.

Sound Source

7. Select **Sound Source** using the ▲/▼ button and press the ◀ or ▶ button to select **Main** or **PIP/TWIN**.

Note : You can hear the sound of small screen or main screen according to your selecting.

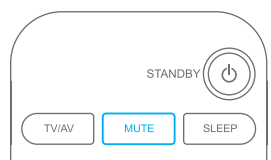

Using the Sound Button in the Remote Control

You can use the Sound button in the remote control. Press the **MUTE** button to mute the sound. If you press again, the sound will be reactivated.

26. Changing the Sound

Setting the Time

Setting the Current Time

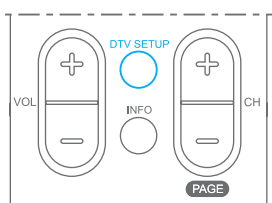

You can set the current time. If you wish to use the Power On or Off Time, you must also set the Local Time.

1. Press the **MENU** button.
2. Select **System** using the ▲/▼ button, and press the **OK** or ► button.
3. Select **Time Setting** using the ▲/▼ button, and press the **OK** or ► button.
4. Select **Date** using the ▲/▼ button, and press the **OK** or ► button.
5. Press the ▲/▼/◀/▶ button to set the current date.
6. When you are satisfied with your choice, press the **OK** button to store the date.
7. Select **Local Time** using the ▲/▼ button, and press the **OK** or ► button.
8. Press the ▲/▼/◀/▶ button to set the current time.
9. When you are satisfied with your choice, press the **OK** button to store the time.

Note : The LCD-TV sets and updates the time automatically by the air, if you successfully search digital terrestrial channels. You must set the GMT Offset value in DTV Setup menu. Refer **DTV SETUP - Preferences - Local Setting menu for more detail information.**

Automatically Turning the TV On and Off

You can automatically switch on or off at the time you select.

1. Press the **MENU** button.
2. Select **System** using the ▲/▼ button, and press the **OK** or ► button.
3. Select **Time Setting** using the ▲/▼ button, and press the **OK** or ► button.
4. Select **Power On/Off Time** using the ▲/▼ button, and press the ◀ or ► button to select **Enable** or **Disable**.
5. In the **Enable** mode, Select **Timer** using the ▲/▼ button, and press the **OK** or ► button.
6. Press the ▲/▼/◀/▶ button to set the time.
7. When you are satisfied with your choice, press the **OK** button to store the time.
8. Select **Auto Power Off** using the ▲/▼ button, and press the ◀ or ► button to select **Enable** or **Disable**. In setting the Auto Power Off to Enable, the LCD TV turns off automatically if there is no signal.

Setting the System



Language

1. Press the **MENU** button.
2. Select **System** using the ▲/▼ button, and press the **OK** or ► button.
3. Select **Language** using the ▲/▼ button, and press the ◀ or ► button to select a particular language.

OSD Transparency

1. Press the **MENU** button.
2. Select **System** using the ▲/▼ button, and press the **OK** or ► button.
3. Select **OSD Transparency** using the ▲/▼ button, and press the ◀ or ► button to set the transparency.
High : Medium : Low

AV Output

1. Press the **MENU** button.
2. Select **System** using the ▲/▼ button, and press the **OK** or ► button.
3. Select **AV Output** using the ▲/▼ button, and press the ◀ or ► button to select a particular thing.
Digital TV : Analog TV : AV1 : AV2

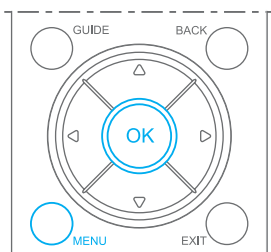

Antenna Power

1. Press the **MENU** button.
2. Select **System** using the ▲/▼ button, and press the **OK** or ► button.
3. Select **Antenna Power** using the ▲/▼ button, and press the ◀ or ► button to select **On** or **Off**.

Aspect Ratio

You can select the picture format you prefer.

1. Press the **MENU** button.
2. Select **System** using the ▲/▼ button, and press the **OK** or ► button.
3. Select **Aspect Ratio** using the ▲/▼ button, and press the ◀ or ► button to select a particular thing. You can also set the **Aspect Ratio** simply by pressing the **ASPECT RATIO** button.

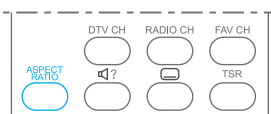

- _ **Auto** : The screen format will automatically become enlarged, allowing you to view the picture at its maximum size.
- _ **4:3 , 14:9 , 16:9** : Setting for the 4:3, 14:9, or 16:9 screen format.
- _ **Zoom1, Zoom2** : Expansion to the Zoom1 or Zoom2 ratio.

Note : If you wish to change the Aspect Ratio, you must set the PIP/TWIN mode to Off. To enlarges the picture to the wide aspect ratio in the Digital TV mode, press the WIDE button. Although the channel is changed, the wide aspect ratio keeps.

Backlight Brightness

1. Press the **MENU** button.
2. Select **System** using the ▲/▼ button, and press the **OK** or ► button.
3. Select **Backlight Brightness** using the ▲/▼ button, and press the ◀ or ► button to set the brightness of LCD panel.
High : Medium : Low

28. Setting the System

Displaying the Teletext Information

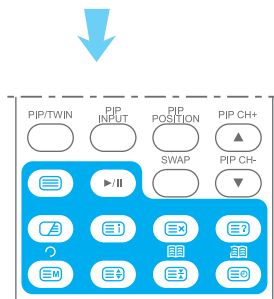
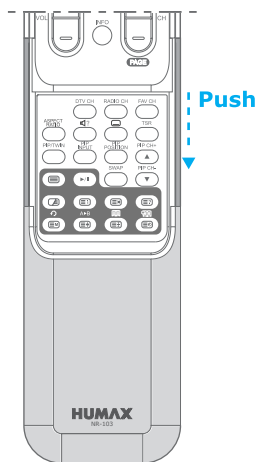

You can display Teletext information at any time on your TV.

Most TV channels broadcast information via teletext. Each channel which broadcasts teletext transmits a page with information on how to use its teletext system. Depending on the TV channel, teletext is transmitted in different systems. The colours used in the options line correspond with the colour buttons of your remote control.









For Teletext information to be displayed correctly, channel reception must be stable, otherwise:

- + Information may be missing
- + Some pages may not be displayed

Press the **TELETEXT** () button to display teletext.

And you can control the Teletext functions using the following buttons.

Special Teletext Functions

TELETEXT		Activate/Deactivate the teletext service.
MIX		Displays the teletext with the broadcasting screen.
INDEX		Displays the teletext index page.
UPDATE		Display the TV picture on the screen while waiting for the new teletext page.
REVEAL		Displays the concealed information.
MODE		Displays the mode.
SIZE		Displays the text size as double size.
HOLD		Hold function during teletext display.
SUBPAGE		Search the sub-page using the sub-code.

You are in teletext mode, so only teletext functions are available.

Setting the PC Input

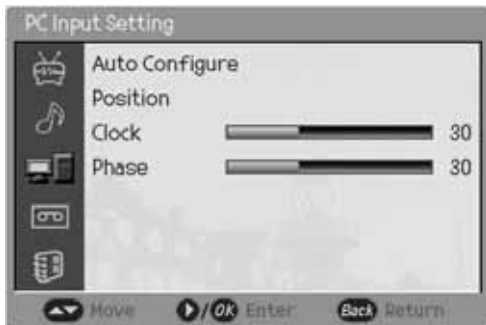
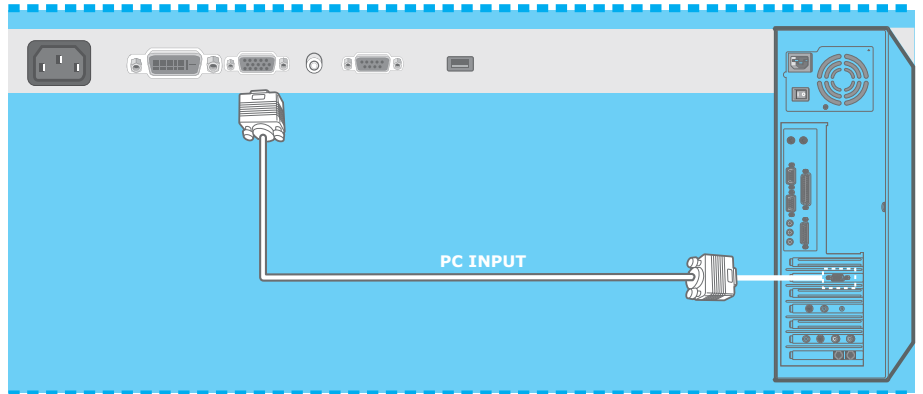
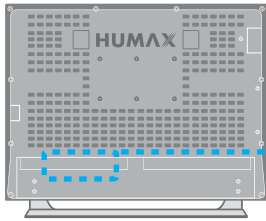

1. Press the **TV/AV** button to switch to **PC** mode.
2. Select **PC** using the **▲/▼** button, and press the **OK** button.
3. Press the **MENU** button.
4. Select **PC Input Setting** using the **▲/▼** button, and press the **OK** or **▶** button.
5. Select the following item using the **▲/▼** button, and press the **OK** or **▶** button.

- _ **Auto Configure** : Automatically optimizes the status of screen.
This is recommended when connecting a new PC.
- _ **Position** : Move the screen to the right, left, bottom or Up.
- _ **Clock** : Adjusts the horizontal size of screen by increasing or decreasing the number of pixels.
- _ **Phase** : Sets the focus of screen.

30. Setting the PC Input

Recording

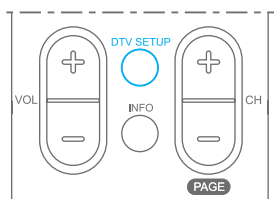
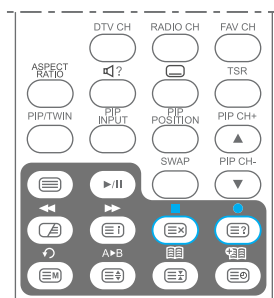
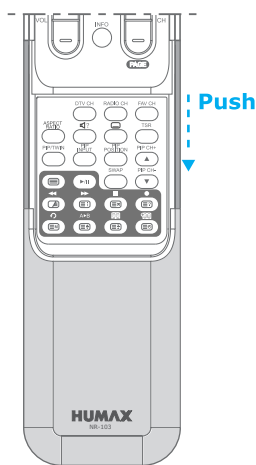

Instant Recording

Since the LCD-TV has a hard disk drive inside, you can record a programme with out an external media device such as a VCR.

1. Press the **RECORD** (●) button on the remote control to record the current programme instantly.
2. You can change the recording duration time by pressing the **RECORD** (●) button repeatedly.

30min -> 60min -> 90min -> 120min -> 240min -> 24hr Max

3. To stop the recording, press the **STOP** (■) button. If there is no time delay while recording a programme, it will stop recording and return to the live broadcasting instantly. Otherwise, if there is a time delay, it will jump to the current point and return to the live broadcasting by pressing the **STOP** (■) button once again.

Note :

- _ When beginning the recording, **REC** () icon is displayed on the upper right-hand side of the screen for about 3 seconds.
- _ You can reset the recording time while recording.
- _ Ensure that there is enough free space before recording, because if the free space on the hard disk drive is insufficient, recording will stop. Recording 1 hour of programme may require up to about 1GB of free space of hard disk space. The space for recording 1 hour of programme may be different depending on the programme recorded and the recorded quality.
- _ It is possible that you may not record the scrambled programme or data programme normally.
- _ You cannot change to other channel during recording analogue channel or scrambled digital programme.
- _ Recording is not available in **Component, DVI or PC Input** sources.
- _ You can change to other input source during recording
- _ You can playback the recorded programme during recording using trick play functions (FF, RW, Instant Replay, Repeat between A and B, Bookmark List and Add Bookmark). See the **Playback Control**.
- _ When you are recording the channel which is watching currently, the subtitle is recorded according to subtitle-setting in start of recording. When you are recording the channel which is not watching currently, the subtitle is recorded according to subtitle-setting in Menu (**DTV SETUP - Preferences - Local Setting - Subtitle Language/Display**).

31. Recording

Recording

Setting the Recording Quality



1. Press the **MENU** button.
2. Select **Recording** using the ▲/▼ button, and press the **OK** or ► button.
3. Select **Recording Quality** using the ▲/▼ button, and press the ◀ or ► button to select a particular thing.

HQ (High Quality) : SP (Standard Play) : LP (Long Play)

Decreasing the record quality decreases the amount of disk space required to store the images, due to a higher compression scheme.

Recording

Recording Reservation

You can reserve recording to record your desired programme automatically. You can reserve recording of a programme using **Menu - Recording - Recording Schedule**.

Adding Recording Reservations



1. Press the **MENU** button.
2. Select **Recording** using the **▲/▼** button, and press the **OK** or **▶** button.
3. Select **Recording Schedule** using the **▲/▼** button, and press the **OK** or **▶** button.
4. Select a blank list using the **▲/▼** button, and press the **OK** button to add a new recording schedule.
5. Select **Channel** using the **▲/▼** button, and press the **OK** or **▶** button to change the channel. Change the Input source and channel No. using the **▲/▼/◀/▶/NUMERICAL(0~9)** button. Press the **OK** to save the changed channel.
6. Select **Date** using the **▲/▼** button, and press the **OK** or **▶** button to change the date. Change the date using the **▲/▼/◀/▶/ NUMERICAL (0~9)** button and press **OK** to save the changed date.
7. Select **Start Time** using the **▲/▼** button, and press the **OK** or **▶** button to change the start time. Change the start time using the **▲/▼/◀/▶/ NUMERICAL(0~9)** button and press **OK** to save the changed start time.
8. Select **Duration** using the **▲/▼** button, and press the **OK** or **▶** button to change the recording duration. Change the recording duration using the **▲/▼/◀/▶/NUMERICAL(0~9)** button and press **OK** to save the changed recording duration. (2 min ~ 24 hours)
9. Select **Repeat** using the **▲/▼** button, and select one among **Once** (**1**), **Daily** (**1**) and **Weekly** (**1**) using the **◀/▶** button.
10. Select **Title** using the **▲/▼** button, and press the **OK** or **▶** button to display a keyboard on the screen. Enter the desired title on the screen keyboard using the **▲/▼/◀/▶** button.
11. Select **Recording Quality** using the **▲/▼** button, and select one among **HQ** (High Quality), **SP** (Standard Play) and **LP** (Long Play) using the **◀/▶** button.
12. Select **Save** and press the **OK** button to complete the editing.
13. Select **Delete** and press the **OK** button to delete the editing.
14. Select **Cancel** and press the **OK** button to cancel the editing.

In Recording Schedule, you can move easily to the Recorded Programmes or HDD Control using the RED or GREEN buttons on the remote control.

33. Recording

Recording

Editing Recording Reservations

1. Press the **MENU** button.
2. Select **Recording** using the ▲/▼ button, and press the **OK** or ► button.
3. Select **Recording Schedule** using the ▲/▼ button, and press the **OK** or ► button.
4. Select a reserved item which you want to edit using the ▲/▼ button, and press the **OK** button.
5. The next editing procedure is the same as **Adding recording reservations**.

When the reserved start time comes, the following message will be displayed on the screen ;

If you select **Yes** and press **OK** button, the recording of the reserved programme is started.

Note :

- _ If the reserved start time comes in the standby mode, no sooner have you turn on the LCD-TV than the confirm message will be displayed on the screen.
- _ If the programme to reserve overlaps with the existing one, adjust the reservation so as not to overlap.
- _ If you want to stop on recording, press the **STOP** (■) button.
- _ When you are recording the channel which is watching currently, the subtitle is recorded according to subtitle-setting in start of recording. When you are recording the channel which is not watching currently, the subtitle is recorded according to subtitle-setting in Menu (**DTV SETUP - Preferences - Local Setting - Subtitle Language/Display**).

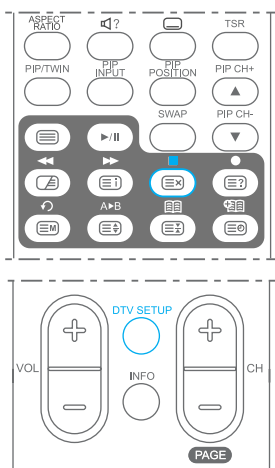

Recording

Time Shifted Recording

This LCD-TV automatically saves the programme on air in the installed hard disk drive temporarily, so that users can watch programmes as they watch a video tape using functions such as rewind, fast forward, instant replay and pause.

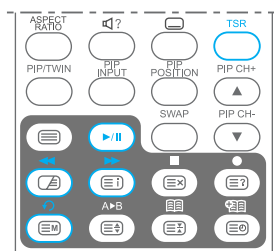

1. On watching TV, press the **TSR** on the remote control until when **Time Shift On** message appears, and the time shifted recording will be started.

If you press the TSR button on watching TV, the current state of time shifted recording will be displayed with a message (Time Shift On or Time Shift Off). If you press it once again, the message will be changed to the other state.

On the channel during time shifted recording, if you press the OK button, TSR On message is shown.

Note : If you press the **PLAY/PAUSE (▶/II)** button on the Time Shift Off state, it will be switched to the Time Shift On automatically and start the time shifted recording.

2. During time shifted recording, you can press the various playback buttons such as **PLAY/PAUSE (▶/II)**, **FORWARD (►►)**, **REWIND (◀◀)** or **INSTANT REPLAY (↺)** to playback the recording data saved temporarily in TSR buffer of the programme you are watching.

Note :

You cannot perform Repeat A-B (A>B) or Bookmark (📌 , 📌) function during time shifted recording.

If you want to playback the programme which is viewing-restricted or locked, will need the password.

3. If you press a playback button, the TSR time bar will be displayed as following and the data will be played according to each playback function. For more information of the playback buttons, refer to **Playback Control**.

TSR Time Bar

TSR time bar displays the current operation status for playback of TSR data.

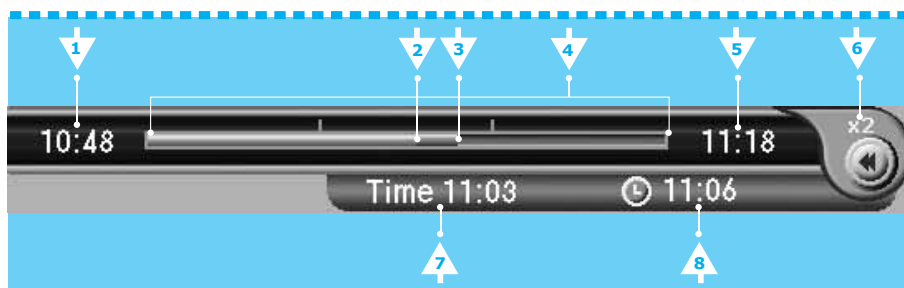

1. Start time of TSR time bar
2. Watching point
3. Live or broadcasting point
4. Total amount of programme saved to TSR buffer (max 30 minutes)
5. End time of TSR time bar
6. Play status (The speed is shown in playing of fast-forward, fast-rewind, slow-forward, slow-rewind.)
7. The time of watching point
8. Current time (The time of live or broadcasting point)

When the play status is PLAY or LIVE on TSR time bar, if you take no action for about 3 seconds, TSR time bar will disappear.

35. Recording

Recording

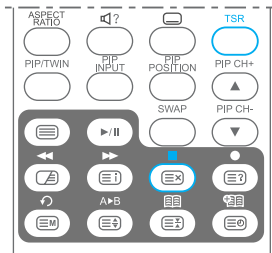

4. If you press the **STOP** (■) button, the TSR time bar will disappear and the playback will be stopped.

5. To stop the time shifted recording, press the **TSR** button until when **Time Shift Off** message appears.

Note :

_ It is possible that you may not record the scrambled programme or data programme normally.

_ Total TSR buffer is limited.

_ During the TSR playback or Programme Playback, the **TruSurround XT** and **Auto Volume Level** menus are disabled.

Playback

Programme Playback

You can watch the recorded programme by selecting a desired programme in the **Menu - Recording - Recorded Programmes** and pressing the **OK** or **PLAY/PAUSE** (▶/||) button.



1. Press the **MENU** button.
2. Select **Recording** using the ▲/▼ button, and press the **OK** or ▶ button.
3. Select **Recorded Programmes** using the ▲/▼ button, and press the **OK** or ▶ button to display the recorded programme list.
4. Select a desired programme to playback using the ◀/▶ button, and then press the **OK** or **PLAY/PAUSE** (▶/||) button to playback the programme.
5. Time bar appears as following and starts playback of the selected programme instantly.

Time Bar

Time bar displays the current operation status.

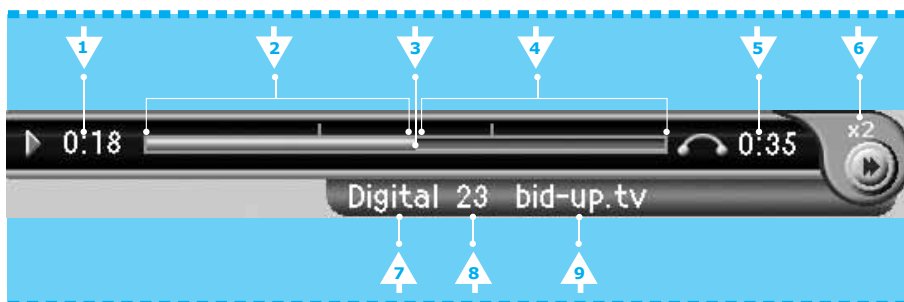

1. The playing time of watching point
2. The played amount of programme
3. Watching point
4. The non-played amount of programme
5. The total recorded time of programme
6. Play status (The speed is shown in playing of fast-forward, fast-rewind, slow-forward, slow-rewind.)
7. Input source mode of the recorded programme (Digital, Analog, AV1/2/3, S-Video)
8. Channel number
9. Programme name

When the play status is PLAY on Time bar, if you take no action for about 3 seconds, Time bar will disappear.

6. You can perform trick play functions like VCR functions such as rewind, forward, slow motion, pause, skip, and replay using the playback control or the additional buttons on the remote control during playback a programme.

37. Playback

Playback

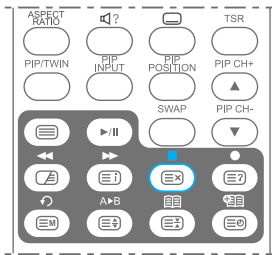

7. Press the **STOP** (■) button to stop the playback. If the playback is ended automatically, the follow message appears and the recorded programme list appears again. (Playback is ended.)

Note :

— See the **Playback Control** for more information about each trick play function.

— You can also playback the programme recorded in the external device (HDD) connected with LCD-TV by the same process.

—  : Indicates the programme currently on recording.

—  : Indicates the programme that the recording had been stopped in the middle of the reserved duration.

—  : Indicates the programme is viewing restricted or locked. Requires the entering password.

— During the TSR playback or Programme Playback, the **TruSurround XT** and **Auto Volume Level** menus are disabled.

In Recorded Programmes, you can move easily to the Recording Schedule or HDD Control using the RED or GREEN buttons on the remote control.

Playback

Editing Recorded Programmes

Select **Menu - Recording - Recorded Programmes**, and then select the desired recorded programme to edit the information of the programme.

Editing Title

You can edit the title of a recorded programme.



1. Select your desired programme in the list using the ◀/▶ button.
2. Select **Edit Title** using the ▲/▼ button, and press the **OK** button to display a keyboard on the screen.
3. Enter the desired programme title on the screen keyboard using the ▲/▼/◀/▶ button.
4. After finishing editing, select **Save**, and then press the **OK** button to complete.

Delete File

You can delete the recorded programme.

1. Select your desired programme in the list using the ◀/▶ button.
2. Select **Delete File** using the ▲/▼ button, and press the **OK** button. Display a message. (Do you want to delete this recorded programme?)
3. Select **Yes** using the ◀/▶ button, and then press the **OK** button to delete the file. If you don't delete the file, select **No** and press the **OK** button.

Copy File to External Device

You can copy the recorded programme from/to external device.

1. Select your desired programme in the list using the ◀/▶ button.
2. Select **Copy file to external device** using the ▲/▼ button, and press the **OK** button. Display the progressing status including copied rate, elapsed time and remaining time. Please wait to copy to external device completely.
3. When the file copy is finished, press the **OK** button. If you want to cancel the copying, select **Cancel** and press the **OK** button.

Note : The file format of external device must be **FAT32** or **Linux file format** for copying to external device. If the file format of external device is mismatched to these file format, initialize the external device at **Menu-Recording-HDD control menu**.

Playback

Connecting the External HDD

You can also save/backup the recorded data to external storage device via USB port located on the rear of the LCD-TV. Connect a USB cable between an external storage device and USB port of the LCD-TV. Then, the External menu will be enabled.

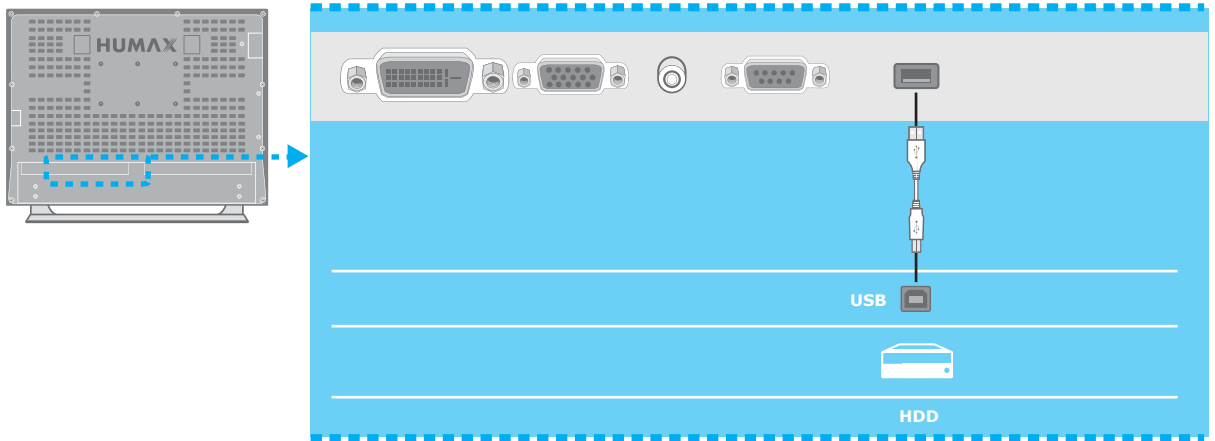

Note : It may not be compatible with the TV according to the sort of external HDD or its case.

Playback

Playback Control

You can perform playback control using playback buttons of the remote controller. You can use trick play functions during instant recording, time shifted recording or playing recorded programme.

PLAY/PAUSE

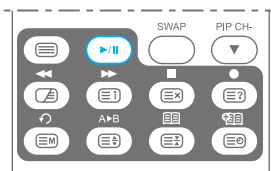

If you press **PLAY/PAUSE** (▶/||) button on the remote controller on playing, the playing is paused. If you press **PLAY/PAUSE** (▶/||) button on pausing, the playing is resumed from paused point.

Note : If you press **PLAY/PAUSE** (▶/||) button during watching TV or AV input, time shifted recording is started automatically.

Rewind to Previous Scene

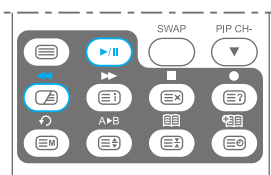

Press the **REWIND** (◀◀) button on the remote controller to watch backward the scene passed by. Whenever you press the **REWIND** (◀◀) button, the rewind speed increases (x2, x4, x8, x16, x24). If you press the **PLAY/PAUSE** (▶/||) button, the programme is played at normal speed. If you press the **REWIND** (◀◀) button on the pause state, the programme is played backward at slow speed (x1/2, x1/4, x1/8, x1/16, x1/24).

Fast Forward to Next Scene

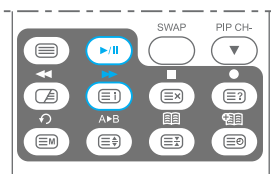

Press the **FORWARD** (▶▶) button on the remote controller to fast forward the programme. Whenever you press the **FORWARD** (▶▶) button, the fast-forward speed increases (x2, x4, x8, x16, x24). If you press the **PLAY/PAUSE** (▶/||) button, the programme is played at normal speed. If you press the **FORWARD** (▶▶) button on the pause state, the programme is played forward at slow speed (x1/2, x1/4, x1/8, x1/16, x1/24).

Recording

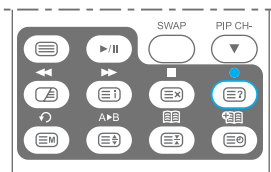

Press the **RECORD** (●) button on the remote controller to start recording the current programme. For more information about recording refer to **Instant Recording**.

Direct Jump

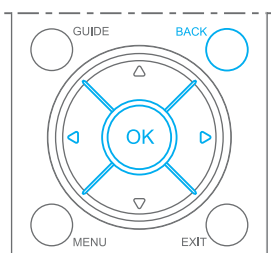



If you press the ◀ or ▶ button during playback, the moving focus appears in the progress bar. Move this arrow to a desired time point using the ◀/▶ button. Press the **OK** button to play the programme at the moved time point. To return the arrow to original play position, press the **BACK** button.

41. Playback

Playback

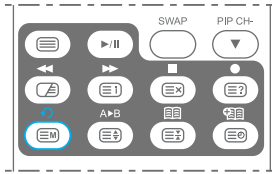

Instant Replay

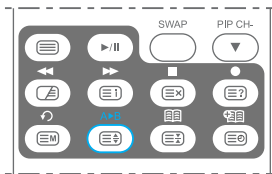

If you press the **INSTANT REPLAY** () button, the current programme is played from the 10 seconds before.

Repeat between A and B





You can play special section repeatedly. You can set the section by pressing the **A-B** () button twice. Press the **A-B** () button once at the desired starting point, and press again at the desired ending point. Then, a mark for the A-B section repetition will be displayed and the section is played repeatedly. To stop the repetition play and return to the normal play, press the **A-B** () button once again.

Bookmark

You can set bookmark where you want to save.

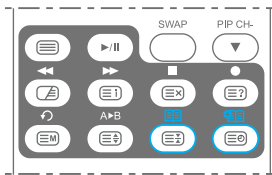
Add Bookmark





Press the **ADD BOOKMARK** () button, when you want to save where you watch. No. and time of the added bookmark are shown on the screen. You can go to that position directly using bookmark list.

Note : The bookmark can be saved up to 5. If you save bookmark over 5, the first bookmark is deleted.

Go to Bookmark



Press the **BOOKMARK LIST** () button, and then the bookmark list appears. Select a bookmark where you want to go using the  /  button, and press the **OK** button to play.

Note : If you press the ADD BOOKMARK () button on displaying the bookmark list, you can add the watching position to bookmark list instead of the selected bookmark.

HDD Control

Checking the Hard Disk Drive

You can check the free space of the hard disk drive, and can format the disk drive if necessary.



1. Press the **MENU** button.
2. Select **Recording** using the ▲/▼ button, and press the **OK** or ► button.
3. Select **HDD Control** using the ▲/▼ button, and press the **OK** or ► button.
4. Select **Internal Device** or **External Device** (if connected) using the ◀/▶ button.
5. You can check the total, TSR buffer, recorded and free space of each HDD.
6. Select **Diagnosis** and press the **OK** button to diagnose the HDD. Diagnosing progress bar appears. After finishing diagnosing, confirm the message and press the **OK** button.
7. Select **Format** and press the **OK** button to remove all the recorded programmes saved on the HDD and initialize the HDD.
8. Select **Yes** and press the **OK** button for the format confirm message, and then is started formatting the HDD. Formatting progress bar appears. To abort formatting, select **Cancel** and press the **OK** button, and then select **Yes** and press the **OK** button.

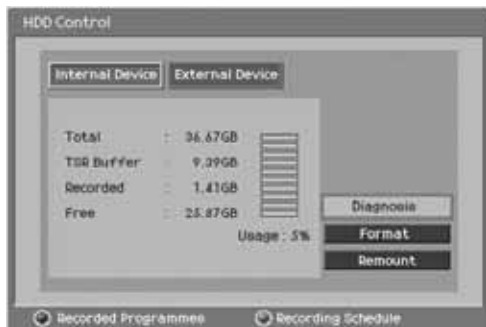

Note :

- You have to be careful because performing format deletes all the recorded programmes saved on the HDD.
- In case of External Device, Remount or Disconnection menu appears. Please connect/disconnect safety using these menus.
- The file format of external device must be FAT32 or Linux file format for copying to external device. If the file format of external device is mismatched to these file format, you should initialize the external device at Menu-Recording-HDD control menu.
- Don't unplug the power cord during format. If you did unplug it, you should perform the format again.



In HDD Control, you can move easily to the Recorded Programmes or Recording Schedule using the RED or GREEN buttons on the remote control.

HDD Control

Connecting the External HDD

You can also save/backup the recorded data to external storage device via **USB** port located on the rear of the LCD-TV. Connect a **USB** cable between an external storage device and **USB** port of the LCD-TV. Then, the External menu will be enabled.

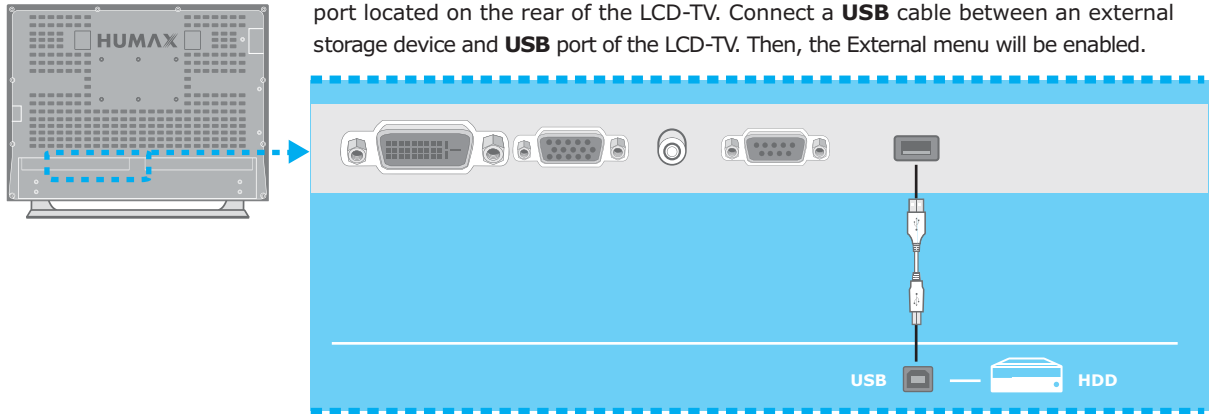

Note : It may not be compatible with the TV according to the sort of external HDD or its case.

Digital TV Channel Setup

When you purchase your LCD-TV, you can run the Automatic Search. It immediately performs Channel Search.(You can also run the digital TV channel setup in Default Setting.)

1. Turns on the TV in the **Digital TV** mode.

2. Starts the Automatic Search immediately. Please wait for finishing the Channel Search. If you want to stop the Channel Search, select the **OK** button. If the Channel Search is stopped or finished, press the **OK** button to save the result of the channel search.

Once the channel search has finished, you can enjoy digital television.



Warning : If you exit the Automatic Search without fully completing the channel searching procedure, you may not have any digital TV channels stored. In this case, you can use the Installation Menu to configure your LCD-TV as required.

Basic Operation

This chapter describes functions such as switching channel, changing language, and basic features for watching programmes.

Switching Channel

You can switch the current channel using one of the following methods.

1. Press the **CH +/-** button.
2. Enter your desired channel number using the **NUMERICAL (0~9)** button to move to the channel directly.
3. Press the **DTV CH** or **RADIO CH** button to switch between TV channel and Radio channel.

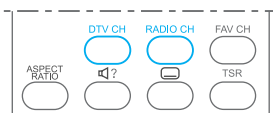

Note : You can switch channel using the channel list or programme guide.

Changing the Subtitle Language

If the current programme provides Subtitle information, you can select the language for the Subtitle.

1. Press the **SUBTITLE** button to display the subtitle language list.
2. Select your desired subtitle language using the **▲/▼** button, and press the **OK** button. Then the subtitle will be displayed in the selected language at the bottom of the screen.
3. Select **OFF** from the subtitle language list if you do not wish to display subtitles in the screen.

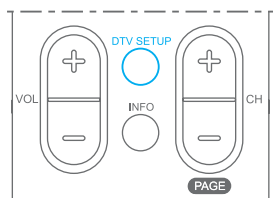
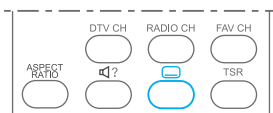

Note :

- _ You can select a default subtitle language by selecting **DTV SETUP - Preferences - Local Setting - Subtitle Language** menu.
- _ In **PIP/TWIN Input** screen, the subtitle is not displayed.

Changing an Audio Language

If the current programme is available in multiple audio languages, you can select the language that you wish to listen in.

1. Press the **SOUNDTRACK/AUDIO** button to display soundtrack list.
2. Select your desired audio language using the **▲/▼** and **OK** button to change the audio soundtrack.
3. Select Audio preference(left, right, stereo) using the **◀/▶** buttons.
4. Press the **EXIT** or **SOUNDTRACK/AUDIO** button to exit the soundtrack list.

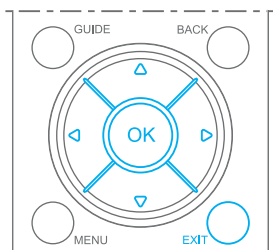
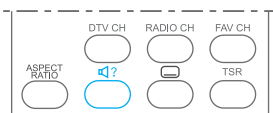

Basic Operation

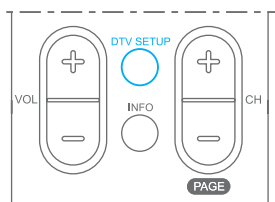

Note :

- _ you can select your desired default audio language by selecting **DTV SETUP- Preferences - Local Setting - Audio Language menu.**
- _ If the programme is broadcast in **Dolby Digital one**, you cannot set the audio preference such as left, right, and stereo.
- _ If you select **Dolby Digital** by selecting **DTV SETUP - Preferences - Local Setting - Audio Priority menu**, **Dolby Digital soundtrack** is automatically used in preference to the default audio language.

Programme Information-Information Banner (I-plate)

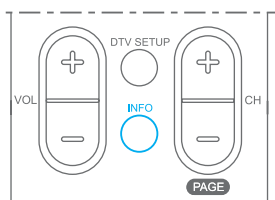

Programme information is always displayed for a specific period of time whenever you switch channels. You can view the programme information by pressing the **INFO** button twice while watching a programme. Press the **EXIT** button to hide the I-plate.

General Information

The General Information is displayed at the bottom of the screen as followings.

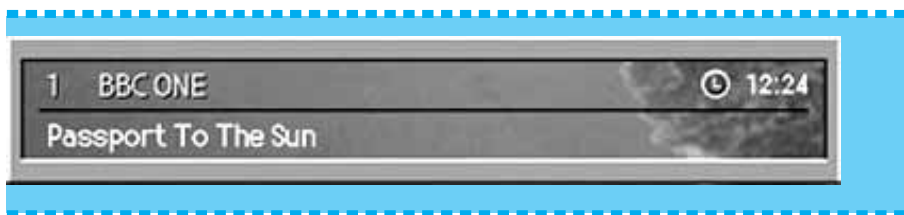

1. Channel number and channel name
2. Programme name
3. Current time
4. Detailed programme information : displayed if detailed programme information is provided.
5. Next programme Information : displayed if next programme information is provided. Press the ► button to display the next programme information.

Note : If there is no available programme information, programme information is not displayed.

Basic Operation

Detailed Programme Information

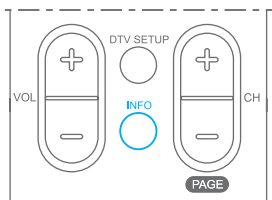







You can see detailed information about the current programme. Press the **INFO** button.

Note :

- Press the **INFO** button again to hide the information box.
- If the detailed programme information is more than one page, use **▲/▼** button to move to the previous or next page.



Icons

-  Represents the recommended minimum age for the current programme.
-  Displayed only when the channel is a locked channel.
-  Displayed only when the channel is a scrambled channel.
-  Displayed only when subtitle information is available.
-  Displayed only when there is any teletext information.
-  Displayed only when the programme is broadcast in Dolby Digital.

Channel List

Displaying and Switching Channel List

You can display channel list using **LIST** button and switch to other channels on the channel list.

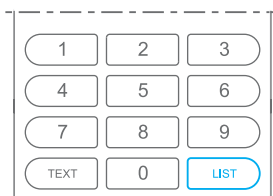

1. Press the **LIST** button while watching a channel to display the channel list.
2. Select your desired channel using the **▲/▼** button and press the **OK** button to change the channel.
3. Enter the channel number directly using **NUMERICAL (0~9)** button to move cursor on to your desired channel. And then press the **OK** button to change to the selected channel.

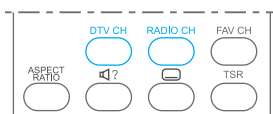
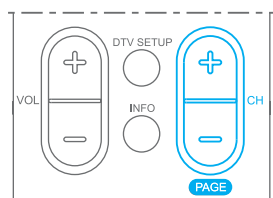

Note :

- _ Within the channel list, press the **PAGE +/-** buttons to move on page-by-page basis.
- _ Whenever you press the **DTV CH** or **RADIO CH** button while the channel list is displayed, the channel list will be switched between the TV and Radio channel list.

Editing Channels

You can edit all channels or each channel by channel list group.

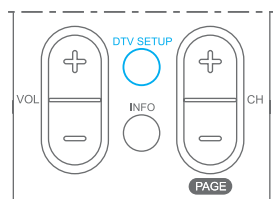

1. Press the **DTV SETUP** button.
2. Select **Edit Channels** using the **▲/▼** button, and press the **OK** or **▶** button.
3. Select **Edit Channel Lists** using the **▲/▼** button, and press the **OK** or **▶** button.
4. You will be prompted to enter your password. Enter your password using **NUMERICAL (0~9)** buttons.



Note :

- _ The Default Password is 0000. If you have forgotten your Password, please contact your local LCD-TV distributor.
- _ Press the **BACK** or **◀** button to save the changes and return to the previous menu, press the **EXIT** button to exit the menu screen.
- _ You can easily navigate all menus using the assigned number for each menu. Press the **DTV SETUP** button then select the numbers 2,1 to select **Edit Channel Lists** menu.

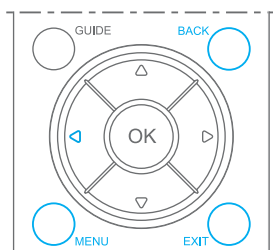

49. Channel List

Channel List

Select a Channel Group

You can select the channel list group to edit TV or Radio.

1. Press the **OK** or **▶** button in **Group** to display channel list group.

2. Select your desired channel list group using the **▲/▼** button, and press the **OK** button.

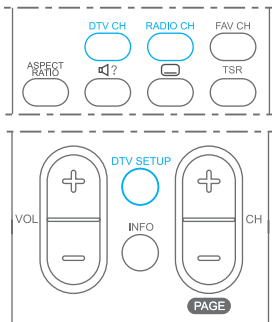
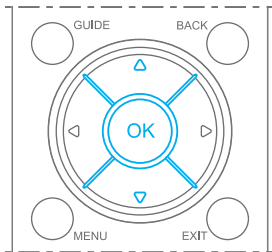

Note :

– Press the **DTV CH** or **RADIO CH** button to move to **TV** or **RADIO** channel list directly.

– For editing Favourite channel list, move to **DTV SETUP - Edit Channels - Edit Favourite Channels** menu.

Delete Channels

You can delete one or more channels.

1. Move the cursor to the channel list using the **◀/▶** button.

2. Select your desired channel, and then press the **OK** button. You can select multiple channels.

3. Select **Delete** in the right using the **▶** button, and press the **OK** button.

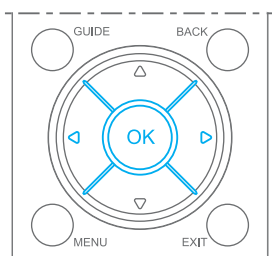

Channel List

Lock/Unlock Channels

You can lock or unlock one or more channels.

1. Move the cursor to the channel list using the ◀/▶ button.
2. Select your desired channel, and then press the **OK** button.
You can select multiple channels.
3. Select **Lock** in the right using the ▶ button, and press the **OK** button.



Select/Unselect All Channels

You can select/unselect all channels at a time.

1. Select **Select All** in the right and press the **OK** button to select all channels.
2. Select **Unselect All** in the right and press the **OK** button to unselect all the selected channels.



Channel List

Editing Favourite Channels

You can edit Favourite channel or Favourite channel list.

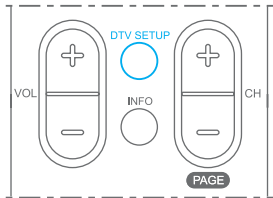

1. Press the **DTV SETUP** button.
2. Select **Edit Channels** using the ▲/▼ button, and press the **OK** button.
3. Select **Edit Favourite Channels** using the ▲/▼ button, and press the **OK** or ► button.
4. Select a channel using the ▲/▼ button, and press the **OK** button. The selected channel is moved into the **Favourite**.



5. Move between **TV** and **Favourite** using the ◀/▶ button. In this way, you can return the channel.

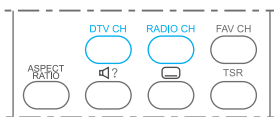

Note :

- Press the **DTV CH** or **RADIO CH** button to move to **TV** or **RADIO** channel list directly.
- Press the **BACK** or ◀ button to save the changes and return to the previous menu. Press the **EXIT** button to exit the Menu screen.

Programme Guide

The Programme Guide displays programme information about each channel, based on the date and time. You can also schedule your recording using the information given.

Note : Press the **GUIDE** button to exit the Guide screen.

Viewing Programme Guide Information

You can view programme information for all channels.

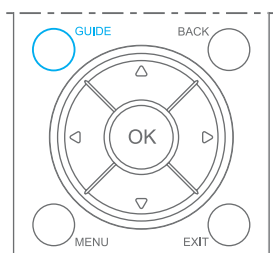

1. Press the **GUIDE** button.
2. Move to previous or next programme within the same channel using the **◀/▶** button.
3. Move to other desired channel using **▲/▼** button. If there are multiple channels, use **PAGE +/-** button to move to channels by page. Also, you can enter your desired channel number using the **NUMERICAL (0~9)** buttons on the remote control to move to the channel directly.



4. Select your desired programme, and press the **OK** button. Then you can watch the programme if it is on air, or you can reserve it if it is the future programme.
5. Press the **INFO** button in the selected programme to view **Extended Information** for the selected programme.

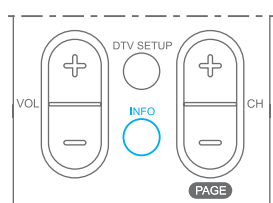

Viewing Guide Information by Another Group

You can view programme information for desired channel list by groups.

1. Press the **GUIDE** button.
2. Press the **RED** button to change the channel list group or press the **DTV CH**, **RADIO CH**, or **FAV CH** buttons.
3. The Programme Guide for selected channel list is displayed.

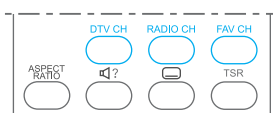

Note : Press the **DTV CH** or **RADIO CH** button to move to **TV** or **RADIO** channel list directly.

53. Programme Guide

Programme Guide

Viewing Programme Information Using Time Bar

You can quickly search for your desired time slot using the Time bar.

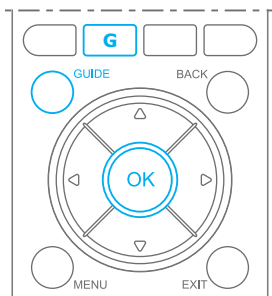

1. Press the **GUIDE** button.
2. Press the **GREEN** button to display the Time Bar.
3. Select the each button using the ◀/▶ button, and press the **OK** button to move as your desired amount of time. If you press the button repeatedly, the same operation is repeated.
4. Each button functions as follows.



Now : Moves to the current programme where the cursor is located.

◀ : Moves to the previous programme or 30 minutes before.

▶ : Moves to the next programme or 30 minutes after.

◀◀ : Moves to 2 hours before.

▶▶ : Moves to 2 hours after.

◀Day : Moves to one day before.

Day▶ : Moves to one day after.

5. Select ↵ and press the **OK** button to exit the Time Bar.

Note : The guide provides programme information from the previous day to the next 7 days.

Finding a Programme

You can find your desired programme by programme name or genre.

Finding a Programme by Programme Name

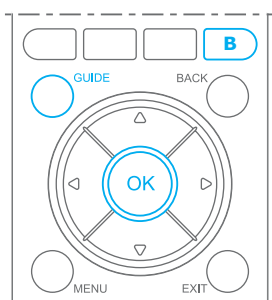

1. Press the **GUIDE** button.
2. Press the **BLUE** button to display Find screen.
3. Enter the programme name directly using the keyboard displayed on the screen.
4. When completing entering programme name, select the **Find**, and press the **OK** button.



Note :

– Select ▲/▼/◀/▶ button and then press **OK** button to enter the programme name on the keyboard screen.

– If you select **Previous** or **Next** on the Keyboard displayed on the screen and press **OK** button, the keyboard layout is switched.

54. Programme Guide

Programme Guide

Finding a Programme by Programme Genre

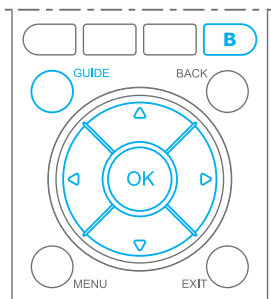

1. Press the **GUIDE** button.
2. Press the **BLUE** button to display Genre screen.
3. Select **By Genre** and press the **OK** button to search programme by genre.
4. Select your desired genre using **▲/▼/◀/▶** button and press the **OK** button.
5. If you select your desired programme from the **Found Programme List** screen and press the **OK** button, you can watch the programme if it is on air.

Note : The Found Programme List may differ depending on the provided programme information.



Adding Reservations by Guide

You can automatically reserve to watch your desired programme.

1. Select the scheduled programme and pressing the **OK** button.
2. Select **OK** using **◀/▶** button and press the **OK** button.
3. When reservation has been completed, the icon () is displayed on the reserved programme.



When you cancel the reservation

1. Select the reserved programme and press the **OK** button. The message will be displayed.
2. Select **OK** and press the **OK** button to cancel the reservation.

Note : You can look into reservation schedule using **YELLOW** button in guide.

55. Programme Guide

Setting the Preferences

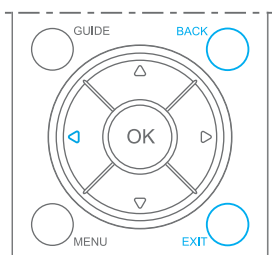

You can set censorship classification, password, time and other options to enhance your viewing pleasure.

Note :

- Press the **BACK** or **◀** button to save the changes and return to the previous menu. Press the **EXIT** button to exit the Menu screen.
- You can easily select all menu items using the assigned numerical button for each menu.

Parental Control

You can set parental control for each programme. You can also change your password.

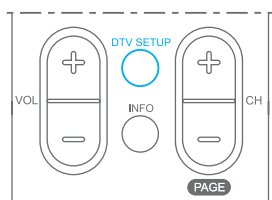

1. Press the **DTV SETUP** button.
2. Select the **Preferences** using the **▲/▼** button, and press the **OK** or **▶** button.
3. Select the **Parental Control** using the **▲/▼** button, and press the **OK** or **▶** button.
4. When prompting message is displayed to ask Password, enter the Password using the **NUMERICAL (0~9)** buttons.



Setting Censorship Classification

Censorship Classification allows you to block programmes according to the age level you have set.

1. Select the **Censorship Classification** using the **▲/▼** button, and press the **OK** or **▶** button.
2. Select your desired **Rating value** using the **▲/▼** button, and press the **OK** button.



View All : All programmes can be watched because there is no age limitation.

P (Pre-school) : This program is designed to be appropriate for pre-school children.

C (Children's) : This program is designed to be appropriate for all children.

G (General Audience) : This program is designed to be appropriate for all ages.

PG (Parental Guidance Recommended) : This program contains unsuitable materials that parents want to prevent their children from watching.

M (Mature Audience 15+) : Programs are blocked for children under the age of 15.

MA (Mature Adult Audience 15+) : Programs are blocked for children under the age of 15.

AV (Adult Audience strong violence 15+) : This program contains the strong violent contents. Therefore, programs are blocked for children under the age of 15.

R (Restricted 18+) : Programs are blocked for children under the age of 18.

Lock All : All Programmes are blocked without considering the age level.

Note : You have to enter your password to watch the programme which is blocked by the age restriction.

56. Setting the Preferences

Setting the Preferences

Changing Password

You can change the current password into a new one.

1. Select **Change Password** using the ▲/▼ button, and press the **OK** or ► button.
2. Enter **New Password** using the **NUMERICAL (0~9)** button, and select **OK** and press **OK** button.
3. Enter the New Password again to confirm the **Verify Password**, and select **OK** and press the **OK** button.



Note : The Default Password is 0000. If you have forgotten your Password, please contact your local LCD-TV distributor.

Local Setting

You can set a Language for Audio, and Subtitles and set the current time.

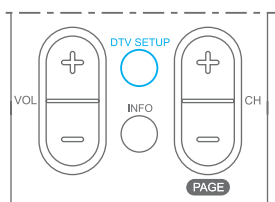

1. Press the **DTV SETUP** button.
2. Select **Preferences** using the ▲/▼ button, and press the **OK** or ► button.
3. Select **Local Setting** using the ▲/▼ button, and press the **OK** or ► button.



Setting Current Time

You can set the GMT Offset for the current time.

1. Select **GMT Offset** using the ▲/▼ button.
2. Press the **OK** or ► button to display GMT list. GMT can be changed in 30 minutes / 1 hour steps.
3. Select your GMT offset using the ▲/▼ buttons, and press the **OK** button.

Note : The current time is set automatically whenever GMT Offset changes. The default item is Auto. If GMT Offset is Auto, the time will change to summer time (BST).

57. Setting the Preferences

Setting the Preferences

Time Zone

You can adjust the time by selecting Time Zone according to your location.

1. Select the **Time Zone** using the ▲/▼ button.
2. Select your desired option using the ▲/▼ button.
NSW/ACT : VIC : QLD : SA : WA : TAS : NT

Audio/Subtitle Language

You can set the language for Audio and Subtitles. The default language is English.

1. Select **Audio / Subtitle Language** using the ▲/▼ button.
2. Press the **OK** or ► button to display the available **Language List**.
3. Select your desired language using the ▲/▼ button, and press the **OK** button.

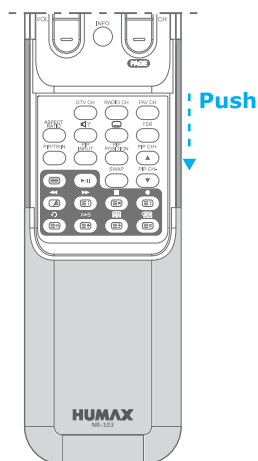

Audio Priority

You can select the audio priority between language and Dolby Digital.

1. Select **Audio Priority** using the ▲/▼ button.
2. Press the **OK** or ► button to display either **Language** or **Dolby Digital**.
3. Select your desired option using the ▲/▼ button, and press the **OK** button.
 - + **Language** : You can watch a programme in the selected language.
 - + **Dolby Digital** : You can listen in Dolby Digital sound.

Subtitle Display

You can select whether or not to display the Subtitle automatically if provided.

1. Select **Subtitle Display** using the ▲/▼ button.
2. Select your desired option using the **OK** or ► button.
 - + **Auto** : Subtitles are displayed automatically in the predefined subtitle language.
 - + **Manual** : Subtitles are displayed in the language when you select the subtitle language by pressing the **SUBTITLE** button on the remote control.

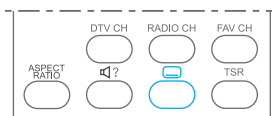

Subtitle Font

You can select the Subtitle font.

1. Select the **Subtitle Font** using the ▲/▼ buttons.
2. Select your desired option using the **OK** or ► button.
 - + **Variable** : Uses the horizontally variable Subtitle Font.
 - + **Fixed** : Uses the fixed Subtitle Font.

Setting the Preferences

Miscellaneous Settings

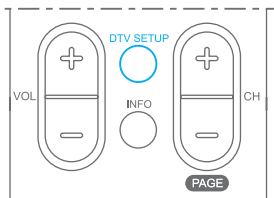

1. Press the **DTV SETUP** button.
2. Select **Preferences** using the ▲/▼ button, and press the **OK** or ► button.
3. Select **Miscellaneous Settings** using the ▲/▼ button, and press the **OK** or ► button.



i-Plate Display Time

You can set the duration during which the Information box is to be automatically displayed when you switch the channel.

1. Select **i-Plate Display Time** using the ▲/▼ button, and press the **OK** or ► button.
2. Select a value between **Disable, 1 ~ 20 seconds** using the ▲/▼ button, and press the **OK** button.

Installation

Automatic Search

If your LCD-TV is connected to a suitable aerial(outdoor aerial recommended) you can automatically search channels without entering any other information.

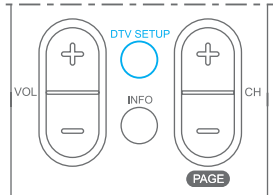

1. Press the **DTV SETUP** button.
2. Select **Installation** using the ▲/▼ button, and press the **OK** or ► button.
3. Select **Automatic Search** from Installation menu using the ▲/▼ button, and press the **OK** or ► button.



Search

Please wait while the LCD-TV searches for the channels, this may take a few minutes.

1. During the automatic search procedure, the cursor is located at **Stop**. If you press the **OK** button during the search, the operation is stopped and the channels found thus far will be displayed.
2. If despite successful completion of search operation the some or all channels have been not found, press the **OK** button and perform to reset the search operation again if necessary.
3. You can delete unnecessary channels from the found channels. Select your desired channels to delete and press the **OK** button. Then select **Delete** and press the **OK** button. To delete all channels, select **Select All** to select all channels, select **Delete**, and press the **OK** button.
4. When completing Channel Search and deleting unnecessary channels, select **Save** to save the changes.



Installation

Regional Search

You can search channels based on state, region, and location.

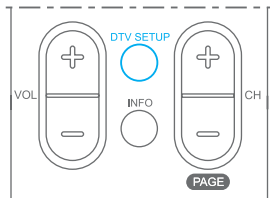

1. Press the **DTV SETUP** button.
2. Select **Installation** using the ▲/▼ button, and press the **OK** or ► button.
3. Select **Regional Search** from Installation menu using the ▲/▼ button, and press the **OK** or ► button.
4. Select **State/Region** using the ▲/▼ button, and press the **OK** or ► button.



5. Select the appropriate options according to your geographical region using the ▲/▼ button, and press the **OK** button.
6. After completing the settings, select **Search**, and press the **OK** button. The following procedures are the same as those for Automatic Search. Refer to Automatic Search.

Installation

Manual Search

You can search channels manually by searching parameters, if you know the multiplex-parameters (check with your local broadcaster).

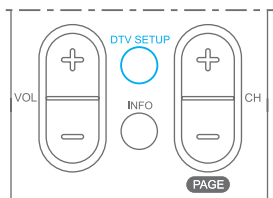

1. Press the **DTV SETUP** button.
2. Select **Installation** using the ▲/▼ button, and press the **OK** or ► button.
3. Select **Manual Search** from Installation menu using the ▲/▼ button, and press the **OK** or ► button.
4. Select **Channel**, **Frequency**, or **Network Search** using the ▲/▼ button, and press the **OK** or ► button.



Channel Number

Enter your desired frequency channel number to search. When entering frequency channel number, the appropriate frequency value is automatically displayed in **Frequency**. Select one of channel using the ▲/▼ button, press the **OK** button.

Frequency

Enter your desired frequency to search directly. When entering the frequency, the appropriate channel for the entered frequency is automatically displayed in **Channel**. Enter frequency using the **NUMERICAL (0~9)** button and press **OK** button.

Network Search

If specified frequency channel information and other channel information are provided together, the channel, which belongs to other frequency channel, is also searched. Select one option between **Enable** and **Disable** using the ► button.

Installation

Default Setting

Default Setting restores the LCD-TV to the default settings

Warning : Please Note that once you perform Default Setting, all data such as Aerial Setting information Channel List, and User Configured data are deleted.

To perform Factory Default:

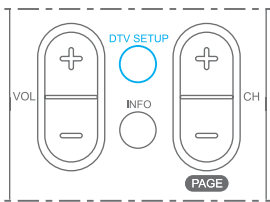

1. Press the **DTV SETUP** button.
2. Select **Installation** using the **▲/▼** button, and press the **OK** or **▶** button.
3. Select **Default Setting** using the **▲/▼** button, press the **OK** or **▶** button.
4. Select **Yes** and press the **OK** button to restore all setting to Factory Default. Select **No** and press the **OK** or **BACK** button to return to the previous menu.
5. Confirm again to start loading default setting. Enter **Password** using the **NUMERICAL (0~9)** buttons to confirm that you wish to restore the default settings.
6. When default setting is completed, Installation Wizard is automatically displayed, which helps Channel Search. For detailed information about Installation Wizard, refer to **Digital TV Channel Setup**.



Note : In the Default Setting, you need a Password to enter. The Default Password is 0000. If you have forgotten your Password, please contact your local LCD-TV distributor.

System Information

You can view all system information, and signal detection.

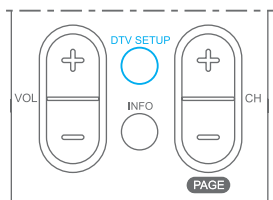

1. Press the **DTV SETUP** button.
2. Select **System** using the ▲/▼ button, and press the **OK** or ► button.



Status

You can view the System information

1. Select **Status** using the ▲/▼ button, and press the **OK** or ► button.
2. Confirm the information about **Hardware version**, **Software version**, **Loader version**, **System ID**, and **Update Date**.



Signal Detection

You can view the signal strength and signal quality reception for the channel that is currently being viewed.

1. Select **Signal Detection** using the ▲/▼ button, and press the **OK** or ► button.
2. Display information about the aerial and multiplex, which current channel belongs to and the graphs and percentage of Signal Strength and Quality of the channel.



System Information

Common Interface

You can view the current status of the CI module.

1. Select **Common Interface** using the ▲/▼ button, and press the **OK** or ► button.
2. Select **Slot 1**, and press the **OK** or ► button.
3. If Common Interface is available, you can view information about each Slot.



Note : The displayed information about each Common Interface may differ depending on Common Interface type.

Game

This LCD-TV provides various games for user's entertainment.

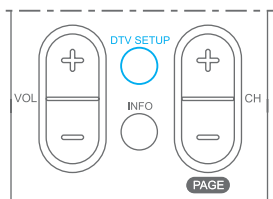

1. Press the **DTV SETUP** button.
2. Select **Games** using the ▲/▼ button, and press the **OK** or ► button.
3. According to the instruction displayed on screen, you can enjoy the game using ◀/▶ and **OK** button.

Note : Press the **EXIT** or **BACK** button to exit the game.

Software Upgrade

In order to maintain proper performance of this LCD-TV, it is essential to have the most up-to-date software. The latest news and release of software versions may be found at the **HUMAX website** (<http://www.humaxdigital.com>). It is recommended that you periodically check for the availability of software update.

Software Update from PC

You can connect your LCD-TV to the PC directly and update your software by transferring the new software from the PC. Follow these steps to download new software from a PC to this LCD-TV.

1. Download new software file(HDF) suitable for this LCD-TV model from our website into your computer (<http://www.humaxdigital.com>).
2. Download and install download tool from our website into your computer.
3. Connect your PC to this LCD-TV with an **RS-232C** serial cable(not supplied).
4. Execute installed download tool, and then follow the instructions contained within the download tool.
5. Reconnect the power cable of the LCD-TV and press the **STANDBY** button to start download.

You can also start download using only the STANDBY button.
Switch off the LCD-TV by pressing the STANDBY button and press again the STANDBY button after about 1 minute.

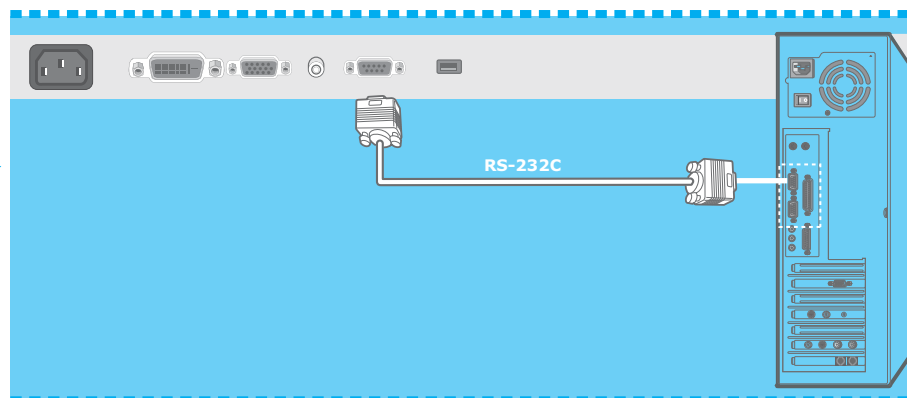
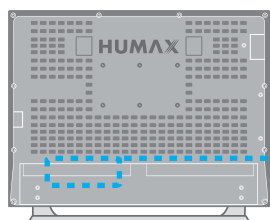
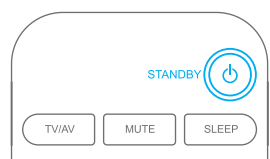

Menu Map

LCD TV Menu

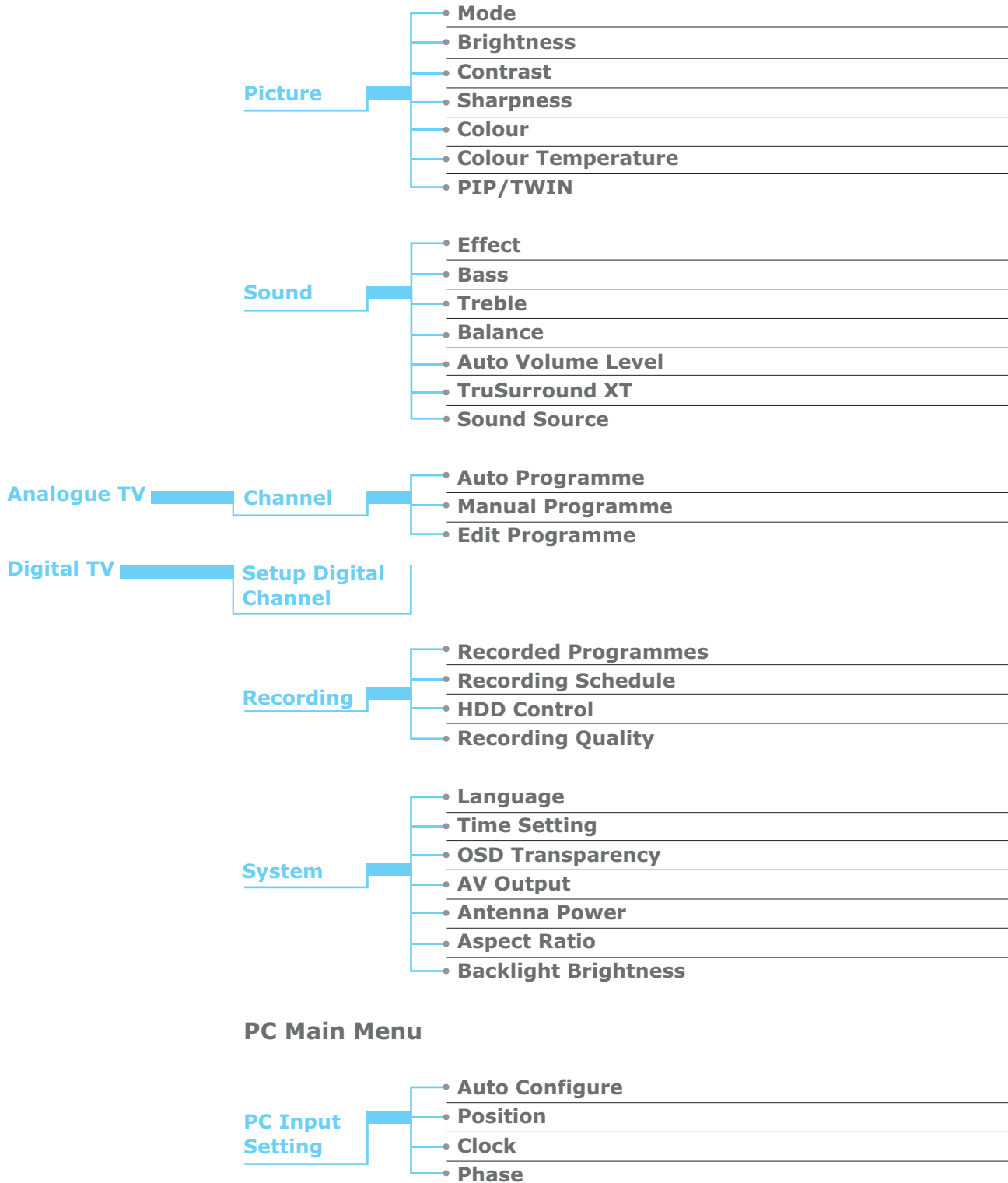

Menu Map

Digital TV MENU

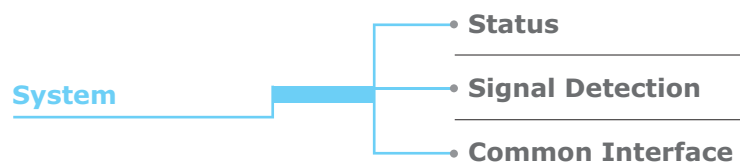
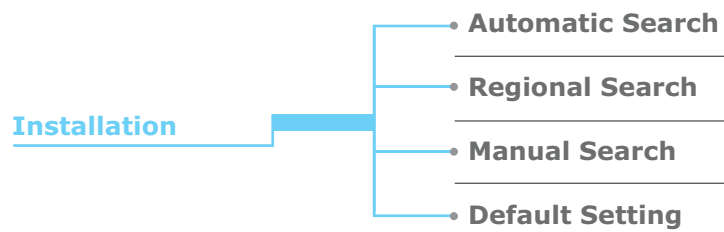
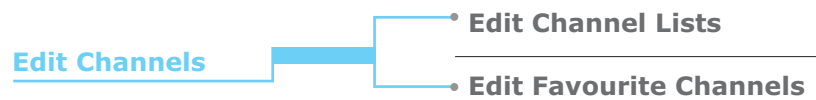
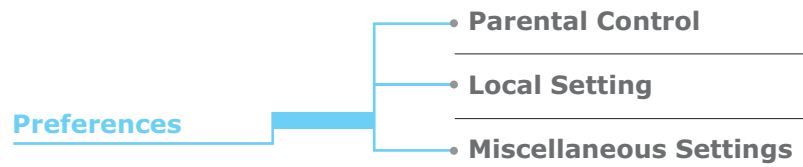

Games

Troubleshooting

Troubleshooting

Before contacting your local service dealer, please make sure you refer to the following guide. If the LCD-TV does not work normally after completing the following trouble shooting, please contact your local LCD-TV distributor or service centre.

1. No message is displayed on the front panel or the LCD-TV has no power

- + Check the main power cable and check that it is plugged into a suitable power outlet.
- + Check whether the Power Switch is On.

2. No picture

- + Make sure that the LCD-TV is in Operation Mode.
- + Make sure that the AV Cable(SCART, SVHS, etc) is firmly connected to the LCD-TV.
- + Make sure that the aerial is correctly connected to the equipment.
- + Make sure that the aerial Setting is correct.
- + Check the brightness level of the LCD-TV.
- + Check the channel is on air.

3. Poor picture & sound quality

- + Install aerial make sure to avoid putting mobile phone or microwave oven near around the equipment.
- + Use 75 Ω coaxial cable to connecting LCD-TV and aerial.

4. No or poor sound

- + Check the volume level of the LCD-TV.
- + Check the Mute status of the LCD-TV.
- + Press the Audio button to change the Sound Track type.

5. Remote Control does not operate

- + To manipulate the equipment with Remote Control, the remote control's emitting part should be pointed directly towards the receiving part of LCD-TV's remote sensor.
- + Check the battery of remote control.

Troubleshooting

Error Message

Error message	Possible causes	What to do
No or bad signal	+ The aerial is not installed correctly.	+ Adjust aerial. + Check the cable from the aerial. If you cannot resolve the problem you may need to have your aerial and installation tested by a professional.
The channel is scrambled or not available.	+ The channel has a signal but no audio or video. + The channel is for data broadcasting.	+ Confirm if the channel is currently on air. + You cannot watch the channel in the usual way.
The channel is scrambled.	+ This digital terrestrial receiver does not support the service that enables descrambling of the scrambled channels.	+ Please contact your local dealer for an appropriate CI Module and viewing card.
The audio is not available.	+ The channel has signal, but no Audio.	+ Press the DTV / AUDIO button to confirm if the channel has Audio.
The fan is out of control: please turn it off.	+ The fan is out of order.	+ Please turn it off. *Contact the call center immediately.

Troubleshooting

Error Message

Problem	Check item
No picture on screen and No sound from speakers.	<ul style="list-style-type: none">+ Insert the AC power cord plug securely in AC power outlet.+ Make sure the remote control is not in the standby mode (The POWER/Standby indicator is Orange colour.)+ Turn on the MAIN POWER button on the bottom of the display.
No picture / No picture from AV terminal.	<ul style="list-style-type: none">+ Check the brightness setting of the display.+ Lamp may have malfunctioned.+ Check the cable from the VIDEO INPUT terminal.
Picture is displayed, But no sound from the Speakers.	<ul style="list-style-type: none">+ Check the sound setting.+ Make sure the sound is not muted.+ Make sure headphones are not connected.+ Check the setting of AV OUTPUT terminal.
Picture is too light.	<ul style="list-style-type: none">+ Check the COLOUR and CONTRAST settings.
Picture is too dark.	<ul style="list-style-type: none">+ Make sure the BRIGHTNESS setting is not set too low.
Remote controller does not work.	<ul style="list-style-type: none">+ Change the batteries.+ Make sure the LCD-TV remote sensor is not facing a strong light source.
The picture is not sharp. The picture moves.	<ul style="list-style-type: none">+ The reception may be weak.+ The quality of the broadcast may also be poor.+ Make sure the aerial is facing the right direction.+ Make sure the outside aerial is not disconnected.
The picture is double or tripled.	<ul style="list-style-type: none">+ Make sure the antenna is facing the right direction.+ The signal may be reflected from mountains or buildings.
The picture is spotted.	<ul style="list-style-type: none">+ There may be interference from cars, trains, high voltage lines, neon lights, etc.+ There may be interference between the aerial cable and power cable.+ Try positioning them further apart.
There are strips on the screen or colours fade.	<ul style="list-style-type: none">+ Is the unit receiving interference from other devices ?+ Transmission antennas of radio broadcasting stations and transmission antenna of amateur radios and cellular phones may also cause interference.+ Use the unit as far apart as possible from devices that may cause possible interference.

71. Troubleshooting

Specification

Specification

Item		Specification	
LCD Panel	+ Type	- Colour active matrix TFT-LCD	
	+ Display Area	- 26.0" (566.4 (W) X 339.84 (H) mm)	
	+ Display Colour	- 16.7 M	
	+ Pixel Pitch	- 0.4425 x 0.4425 mm	
	+ Max. Resolution	- 1280 x 768 pixels	
	+ Interface	- LVDS Interface with 1 pixel / clock	
	+ Viewing Angle	- R/L : 170 , U/D : 170 (CR≥10)	
	+ Contrast Ratio	- 800:1 (Typ)	
	+ Brightness	- 450 cd/m ² (Typ)	
	+ Horizontal Frequency	- 48.5 kHz (Typ)	
	+ Vertical Frequency	- 60 Hz (Typ)	
	+ Dimension	- 627.0 (H) x 389.0 (V) x 49.0 (D) mm (Typ)	
PC Monitor	+ Sync	- Separate	
	+ Horizontal Frequency	- 31~61kHz	
	+ Vertical Frequency	- 56~75Hz	
	+ Max. Resolution	- 1280 x 768 pixels @ 60Hz	
Input / Output	+ Video Input	- Analog Tuner(1), Digital Tuner(2), RCA(3), RGB, S-Video, Component, DVI	
	+ Video Output	- RCA	
	+ Audio Input	- PC Audio, Component (R / L), RCA (R / L) x 3	
	+ Audio Output	- S/PDIF, Speaker, Headphone, RCA (R / L)	
	+ Data Interface	- RS-232C (for S/W Upgrade), USB 2.0 (for PVR)	
TV Signal		Analogue	Digital
	+ Area	- EU	- EU
	+ Antenna Input	- IEC 169-2 Female	- IEC 169-2 Female
	+ Tuning System	- FS	- OFDM DVB-T
	+ Colour System	- BG, I, DK	- BG, I, DK
	+ Sound System	- NICAM, A2	- MPEG1 Layer 1/2
	+ VHF Low	- 48.25 ~ 158MHz	- 51MHz ~ 858MHz
	+ VHF alta	- 160 ~ 442MHz	
	+ UHF	- 442 ~ 863.25MHz	
	+ Teletext	- Yes	- Yes
Regulation	+ Safety	- CE	
	+ EMI	- CE	
Others	+ Power	- 146.3 W (~ 1.70A, Max)	
	+ Speaker Output	- 7W x 2EA	
	+ Plug & Play Level	- DDC 1/2B	
	+ Weight	- NET 22.5Kg / Gross 27.5Kg	
	+ Power Supply	- AC 100 ~ 240V, 50/60Hz	
	+ HDD	- 40G	

72. Specification

Glossary

Programme Guide (Electronic Programme Guide, EPG)

A electronic program guide (EPG) is transmitted by the broadcasters.

Frequency

The number of cycles or events per one second, which is expressed in the unit of hertz

FTA (Free- To-Air)

An unscrambled broadcast, which you can view without additional payments to a service provider.

Hi-Fi (High Fidelity)

The characteristics of audio devices that can play back all the audio frequencies, which are in the range of 16Hz~20KHz, uniformly from low frequencies to high frequencies.

OSD (On Screen Display)

The function that displays the information about the monitor that the user needs or has to know on the screen directly. OSD information includes brightness, contrast, tuning, RGB adjustment, and screen size and positions (top, left, width, and height), and so on.

OTA (Over The Air)

An abbreviation of over the air, means that software can be downloaded through your aerial.

S/PDIF (Sony/Philips Digital Interface format)

Optical format for digital audio output. It outputs audio signals directly as digital audio signals without changing into analogue signals because conversion into analogue signals can degrade signal quality.

Service and Support

You can get information such as a troubleshooting guide, software upgrades and product support guide from the following web sites and call center (Hotline). Please try to contact to your local dealers first when you have any problem.

Web site and e-mail

Homepage

http://www.humaxdigital.com	(English)
http://www.humaxdigital.com	(Deutsch)
http://www.humaxarabia.com	(Arabic)

HCSA (Humax Customer Service Area)

Software Download, Information and Technical Q&A

http://www.humaxdigital.com / hcsa	(English)
http://www.humaxdigital.com /Deutsch / hcsa	(Deutsch)

E-mail (Technical Q&A)

tech-info@humax-digital.co.uk	(Europe & North Africa)
techinfo@humax-digital.de	(Germany)
callcenterME@humaxdigital.com	(Middle East)
Webmaster@humaxdigital.com	(Asia & Other area)

Call Center

HUMAX Hotline (United Kingdom)

Tel : 0870 247 8800
Fax : +44 2891 812 932
E-mail: uksupport@humax-digital.co.uk
Open : Local Time in UK (GMT+0)
08:30~18:00 (Monday - Friday)
Support Language : English

HUMAX Hotline (Germany)

Germany: 01805 778 870 (0,12/Min)
Other Countries: + 49 1805 778 870 (0,12/Min+ International Call Charge)
Open: Local Time in Germany (GMT+1)
08:00 - 20:00 (Monday - Friday)
08:00 - 18:00 (Saturday)
Support Language: Deutsch/English

HUMAX Hotline (Italy)

Tel : 899 100080
Fax : +39 0471 543749
E-mail : info@mediasat.com
Open : Local Time in Italy (GMT+1)
08:00~18:00 (Monday - Friday)
Support Language : Italian

For hardware repair, please refer to support website. (Homepage or HCSA)

74. Service and Support

HUMAX

LCD-TV
Digital and Analogue

HTVAU26TPVR_200GB
P/N 20010-0270

Free Manuals Download Website

<http://myh66.com>

<http://usermanuals.us>

<http://www.somanuals.com>

<http://www.4manuals.cc>

<http://www.manual-lib.com>

<http://www.404manual.com>

<http://www.luxmanual.com>

<http://aubethermostatmanual.com>

Golf course search by state

<http://golfingnear.com>

Email search by domain

<http://emailbydomain.com>

Auto manuals search

<http://auto.somanuals.com>

TV manuals search

<http://tv.somanuals.com>