

Digital Set-Top Box

for **Viaccess Embedded**

HUMAX

Contents

Important Safeguards	1 ~ 4
Support & Copyright	5
Reference	6
Connecting the Set-Top Box.....	7 ~ 10
Remote Control Unit	11 ~ 12
Guide of Functions	13 ~ 15
Guide of Main Menu	16 ~ 30
Troubleshooting Guide.....	31 ~ 32
Menu Map	33 ~ 34
Specification.....	35 ~ 36

VIACCESS . . .







Important Safeguards

This device complies with part 15 of the FCC Rules.

Operation is subject to the following two conditions:

- (1) This device may not cause harmful interference.
- (2) This device must accept any interference that may cause undesired operation.

This television receiver provides display of television closed captioning in accordance with §15.119 of the FCC rules.

	CAUTION RISK ELECTRIC SHOCK DO NOT OPEN		
	This symbol indicates "dangerous voltage" inside the product that presents a risk of electric shock or personal injury.		This symbol indicates important instructions accompanying the product.
CAUTION: TO REDUCE THE RISK OF FIRE OR ELECTRIC SHOCK, DO NOT EXPOSE THIS APPLIANCE TO RAIN OR MOISTURE.			

CAUTION - TO PREVENT ELECTRIC SHOCK, MATCH WIDE BLADE OF PLUG TO WIDE SLOT, FULLY INSERT.

**WARNING - TO REDUCE RISK OF FIRE OR SHOCK HAZARD,
DO NOT EXPOSE THIS RECEIVER TO RAIN OR MOISTURE.**

Always be careful when using your product. To reduce the risk of fire electrical shock and other injuries, keep these safety precautions in mind when installing, using and maintaining your machine.

- Read all safety and operating instructions before operating your product.
- Keep the safety and operating instructions for future reference.
- Heed all warnings on the product receiver and in the operating instructions.
- Follow all operating and use instructions.
- Unplug the product from the wall outlet before cleaning.
Use a damp cloth. Do not use liquid or aerosol cleaners.
Use a damp cloth for cleaning.
- Never add any attachments and/or equipment without approval of the manufacturer. Such additions can increase the risk of fire, electric shock or other personal injury.
- Do not use the product where contact with or immersion in water is a possibility, such as near bathtubs, sinks, washing machines, swimming pools etc.
- Do not place the product on an unstable cart, stand, tripod, bracket or table where it can fall. A falling product can cause serious injury to a child or adult and serious damage to the appliance. Use only with a cart, stand, tripod, bracket or table recommended by the manufacturer or sold with the product. Follow the manufacturer's instructions when mounting the unit and use a mounting accessory recommended by the manufacturer. Move the product and cart with care. Quick stops, excessive force and uneven surfaces can make the unit and cart unsteady and likely to overturn.
- Provide ventilation for the product. The unit is designed with slots in the cabinet for ventilation to protect it from overheating. Do not block these openings with any object and do not place the product on a bed, sofa, rug or other similar surface. Do not place it near a radiator or heat register. If you place the product on a rack or bookcase, ensure that there is adequate ventilation and that you've followed the manufacturer's instructions for mounting.



Important Safeguards

- Operate your product only from the type of power source indicated on the marking label. If you are not sure of the type of power supplied to your home, consult your appliance dealer or local power company.
- Use only a grounded or polarized outlet. For your safety, this product is equipped with a polarized alternating current line plug having one blade wider than the other. This plug will fit into the power outlet only one way. If you are unable to insert the plug fully into the outlet, try reversing the plug. If the plug still does not fit, contact your electrician to replace your outlet.
- Protect the power cord. Power supply cords should be routed so that they won't be walked on or pinched by objects placed on or against them. Pay particular attention to cords at plugs, convenience receptacles and the point where they exit from the unit.
- Unplug the product from the wall outlet and disconnect the antenna or cable system during a lightning storm or when left unattended and unused for long periods of time. This will prevent damage to the unit due to lightning and power-line surges.
- Avoid overhead power lines. An outside antenna system should not be placed in the vicinity of overhead power lines or other electric light or power circuits or where it can fall into such power lines or circuits. When installing an outside antenna system, be extremely careful to keep from touching the power lines or circuits. Contact with such lines can be fatal.
- Do not overload the wall outlet or extension cords. Overloading can result in fire or electric shock.
- Do not insert anything through the openings in the unit, where they can touch dangerous voltage points or damage parts. Never spill liquid of any kind on the product.
- Ground outdoor antennas. If an outside antenna is connected to the product, be sure the antenna is grounded so as to provide some protection against voltage surges and built-up static charges. Section 810 of the National Electrical Code, ANSI/NFPA No.70-1984, provides information about proper grounding of the mast and supporting structure, grounding of the lead-in wire to an antenna discharge unit, size of grounding conductors, location of antenna discharge unit, connection to grounding electrodes and requirements for the grounding electrode.

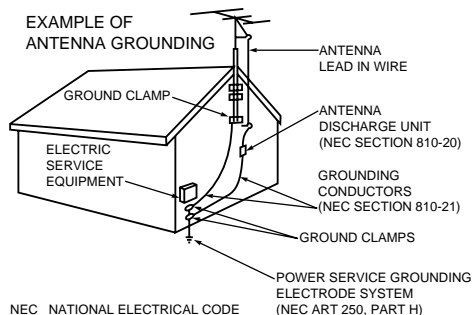

- Do not attempt to service the product yourself. Refer all servicing to qualified service personnel. Unplug the unit from the wall outlet and refer servicing to qualified service personnel under the following conditions:
 - when the power-supply cord or plug is damaged
 - if liquid has been spilled on the unit or if objects have fallen into the unit
 - if the product has been exposed to rain or water
 - if the product does not operate normally by following the operating instructions
 - if the product has been dropped or the cabinet has been damaged
 - when the product exhibits a distinct change in performance
- If you make adjustments yourself, adjust only those controls that are covered by the operating instructions. Adjusting other controls may result in damage and will often require extensive work by a qualified technician to restore the product to normal.
- When replacement parts are required, be sure the service technician uses replacement parts specified by the manufacturer or those that have the same characteristics as the original part. Unauthorized substitutions may result in additional damage to the unit.
- Upon completion of any service or repairs to this product, ask the service technician to perform safety checks to determine that the product is in a safe operating condition.
- CATV system installation: this reminder is provided to call the CATV system installer's attention to article 820-40 of the nec that provides guidelines for proper grounding and in particular, specifies that the cable ground shall be connected to the grounding system of the building, as close to the point of cable entry as practical.

Support & Copyright

First and foremost, our knowledge of the set top box marketplace along with technical expertise differentiates HUMAX. Moreover, we maintain very close working relationships with our customers. We take a highly disciplined engineering approach to product design, manufacture, testing, acceptance and to technical and maintenance support. We conduct comprehensive testing of the units, provide complete documentation and support and deliver the highest quality, most consistent products on time and every time.

HUMAX supports you via its homepage with useful information and new software of the HUMAX's homepage.

Homepage : <http://www.humaxdigital.com>

To provide you the convenience of usage HUMAX has the right to make changes and improvements to any of the products described in this manual and the manual of the products without notice.

Copyright© 2000. HUMAX Co., Ltd.
All rights reserved.

Warning

HUMAX cannot be held responsible for any kind of problems caused by the use of unofficial software. The use of software versions other than HUMAX official software will void the manufacture's warranty.

It is advised that only the formal software released from HUMAX should be used in all HUMAX product range.

Reference

1. Connect a Satellite antenna

To the digital receiver, you can connect either a single satellite antenna directly or through converter box several antennas or LNB of multi-feed equipment.

You can connect a further Sat-receiver (for example analog), with the receiver of common antenna equipment that has satellite signals.

2. Loop Through

If you have another analogue or digital STB and you wish to use the same LNB then you can connect it via the loop through. Connect one end of a Coaxial cable to the LNB OUT on the STB and connect the other end to the LNB IN on your second STB.

3. Software Upgrade

HUMAX digital set-top box is a highly sophisticated product - incorporating one of the best software applications. Whenever a problem is found with this software or, in fact, extra functions or enhanced applications are added, the software in the equipment has to be upgraded.

In order to maintain proper performance of the product, it is essential to have the most up to date software. The latest news and release of software versions may be found at HUMAX website - <http://www.humaxdigital.com>.

It is recommended that users register to HCSA (HUMAX Customer Service Area) and periodically check for the availability of software upgrade.

There are three methods to upgrade the software:

- (a) set-top box to set-top box download (copies the software of the main unit into slave unit);
- (b) pc to set-top box download (downloads the software directly from pc to the model requiring upgrade);
- (c) OTA over-the-air (downloads the software where the manufacturer reserves the right to decide when and where to release through satellite system).

Over The Air (OTA) is simply another alternative for downloading software versions.

However, the manufacturer reserves the right to decide when and where this software upgrade can take place by "beaming" latest software versions over the air via satellite systems. Note that OTA is only limited to certain geographical regions mainly due to different satellites having different footprints (area where the signal can be received).

SUSS (TM) is an official trademark and logo for HUMAX loader software to perform OTA.

The software upgrade via satellite system will only occur under the following circumstances:

- 1) the equipment should have appropriate loader software;
- 2) the manufacturer decides to release software downloading via a designated satellite system;
- 3) the equipment must be "tuned" properly to the same satellite that the manufacturer uses.

Connecting the Set-Top Box

Front & Real Panel

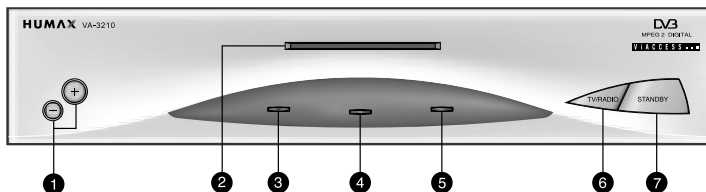

- 1** **- , +**
Press to change services down and up.
- 2** **SMART CARD SLOT**
Insert the SMART CARD with it's IC-Chip part facing the bottom side.
- 3** **ERROR LED (AMBER)**
Indicates that the STB has an error.
- 4** **STANDBY LED (RED)**
Indicates that the STB is under Standby.
- 5** **OPERATING LED (GREEN)**
Indicates that the STB is operating.
- 6** **TV/RADIO**
Press to switch between TV and Radio modes.
- 7** **STANDBY**
Press to switch between Operation and Standby modes.

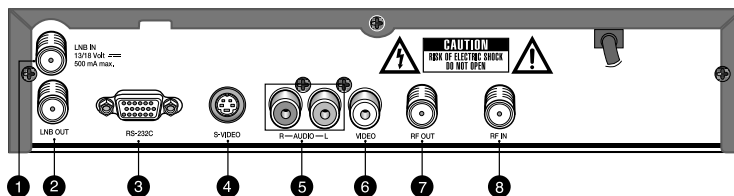

- 1** **LNB IN**
Use to connect an antenna.
- 2** **LNB OUT**
Use it when connecting to another STB.
- 3** **RS-232C**
Use it when connecting to your PC.
- 4** **S-VIDEO**
Use to connect an S-VIDEO signal from your STB to an S-VIDEO input jack on a VCR or TV.
- 5** **RCA AUDIO OUTPUT**
Use to connect an audio signal from your STB to an audio input jack on a VCR or TV.
- 6** **RCA VIDEO OUTPUT**
Use to connect video signal from your STB to a video input jack on a VCR or TV.
- 7** **RF OUT**
Use to connect a RF signal from your STB to RF(ANT) input jack on your TV.
- 8** **RF IN**
Use to connect a general AIR ANT and CABLE jacks to a RF in jack on the STB.

Connecting the Set-Top Box to Your TV (using a RF CABLE)

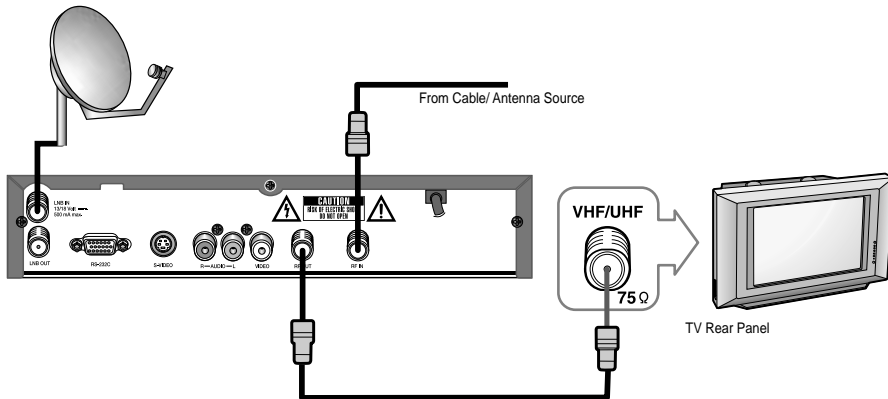

1. Connect a parabola antenna cable to the LNB IN jack.
Connect an AIR or Cable Box Antenna out terminal to the RF IN jack.
2. Connect between the RF OUT jack on the STB and the ANT INPUT (RF INPUT) jack on the TV.

Viewing the STB programs

3. Turn on your STB and TV.
4. Tune the STB to VHF Channel 3 or Channel 4.
5. Tune the TV to Channel 3 or Channel 4 (same as you tune the STB).
6. Operate the STB to select a program you want to watch.

Viewing the Free-To-Air or CABLE programs

7. Switch to the STB Standby Mode.
8. Select a channel you want to watch using the TV remote control.

Connecting the Set-Top Box

Connecting the Set-Top Box to Your TV (using a RCA CABLE)

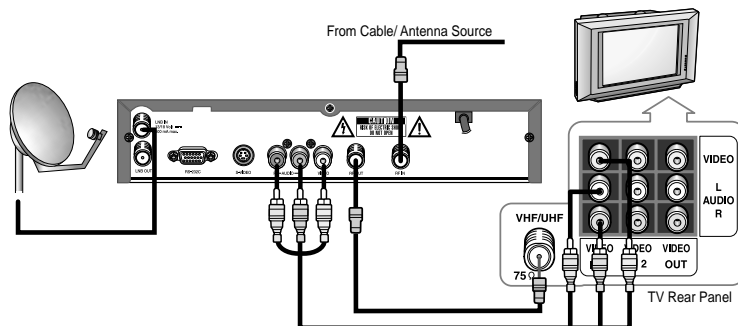

1. Connect a parabola antenna cable to the LNB IN jack.
Connect an AIR or Cable Box Antenna out terminal to the RF IN jack.
2. Connect between the RF OUT jack on the STB and the ANT INPUT (RF INPUT) jack on the TV.
3. Connect a set of audio, video cables between the AUDIO, VIDEO OUT jacks on the STB and the AUDIO, VIDEO INPUT jacks on the TV.

Viewing the STB programs

4. Turn on your STB and TV.
5. Switch to the Video mode using the TV remote control.
6. Operate the STB to watch a program you want.
An S-Video Cable produces better picture quality than a Video Cable.

Viewing the Free-to-Air or CABLE programs

7. Switch to the STB Standby mode.
8. Switch to the TV Air mode using the TV remote control and then select a TV channel you want to watch.

Using a HI-FI SYSTEM for sound

9. Connect a set of audio cables between the AUDIO OUT jacks on the STB and the AUDIO (LINE, AUX) INPUT jacks on the HI-FI SYSTEM.

Connecting the Set-Top Box to Your TV and VCR

You can view a STB program and record it using a VCR at the same time.

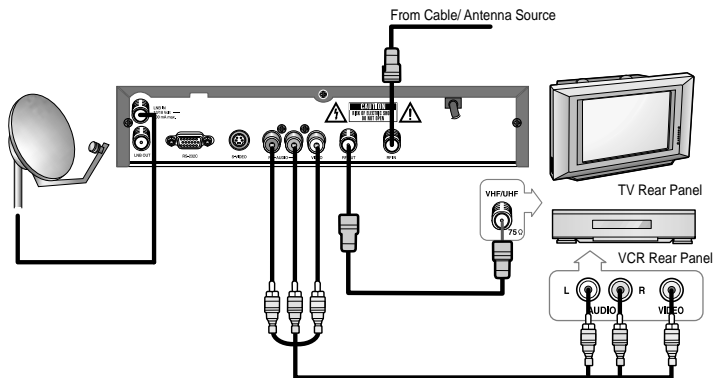

1. Connect a parabola antenna cable to the LNB IN jack.
Connect an AIR or Cable Box Antenna out terminal cable to the RF IN jack.
2. Connect between the RF OUT jack on the STB and the ANT INPUT (RF INPUT) jack on the TV.
3. Connect a set of audio, video cables between the AUDIO, VIDEO OUT jacks on the STB and the AUDIO, VIDEO INPUT jacks on the VCR.

Recording a program from STB

- Turn on the VCR to record a program from the STB.
- When you record a STB program of a specific time, set the Wakeup Time and Service No. of the STB Time Setting Mode to meet the starting time of the program and then do ON.
- Time and Recording Time of the VCR Time Setting Mode.
(See your VCR manual for VCR ON Time and setting the Recording Time.)

Viewing a program from the STB, Free-To-Air or CABLE

- See "Connecting the Set-Top Box to your TV (using a RF CABLE)."

Remote Control Unit

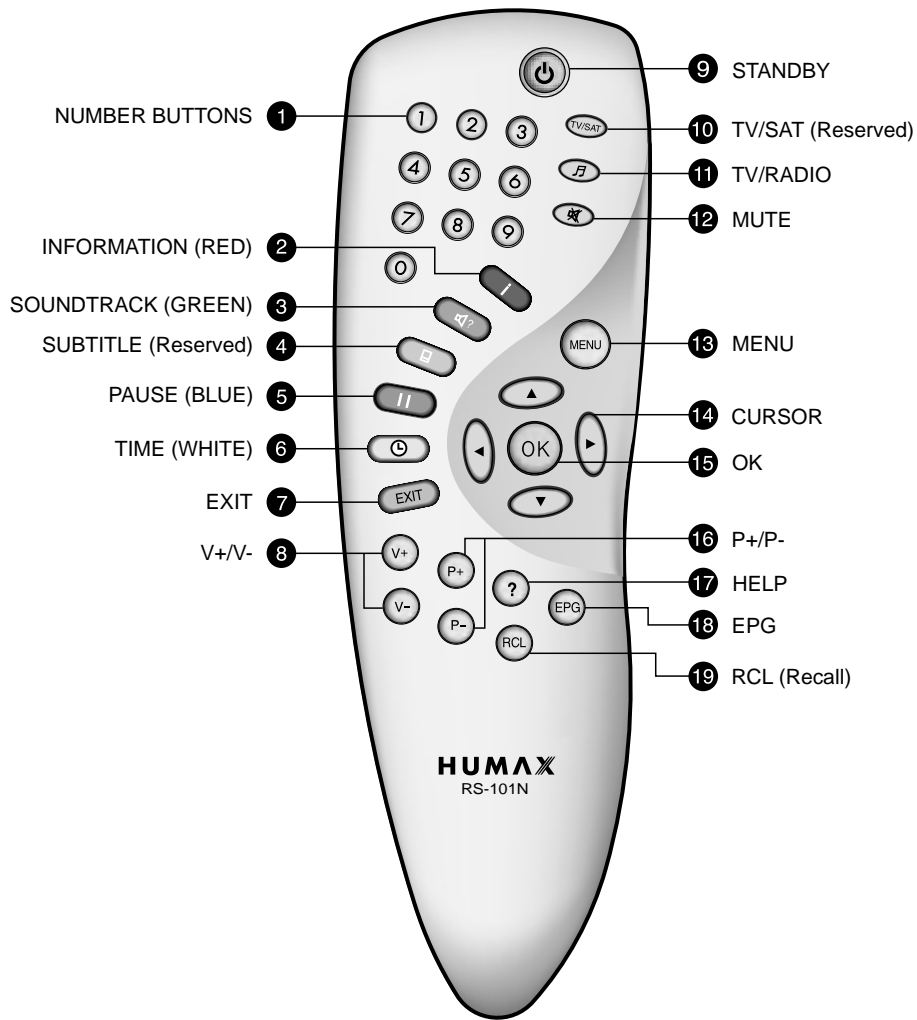

- 1 NUMBER BUTTONS**
Press to select a service, enter your PIN Code or Numbers on the menu.
- 2 INFORMATION (RED)**
Press to display the program information box on the screen. This button functions same as the RED button on the menus.
- 3 SOUNDTRACK (GREEN)**
Press to display the soundtrack list for the current service. And this button functions same as the GREEN button on the menus.
- 4 SUBTITLE (Reserved)**
- 5 PAUSE (BLUE)**
Press to pause the moving picture for seeing more careful. And this button functions same as the BLUE button on the menus.
- 6 TIME (WHITE)**
Press to display the current time on the screen. Press to reserve services on the Information box or EPG. And this button functions same as the WHITE button on the menus.
- 7 EXIT**
Press to return to the previous menu and screen.
- 8 V+/V-**
Volume up/down buttons.
Press to increase or decrease the volume.
- 9 STANDBY**
Press to switch between Operation and Standby modes.
- 10 TV/SAT (Reserved)**
- 11 TV/RADIO**
Press to switch between TV and Radio modes.
- 12 MUTE**
Press to temporarily cut off the sound.
- 13 MENU**
Press to display the Main Menu on the screen or return to the screen from a sub menu screen.
- 14 CURSOR**
Press to move the highlight bar for selecting options on the menus.
And this button is used to change services (up/down) and increase or decrease the audio volume.
- 15 OK**
Press to display the service list.
This button is used to select the item on the menus.
- 16 P+/P-**
Program up/down buttons.
Press to tune to the next or previous service.
Press to move up or down pages on the menus.
- 17 HELP**
Press to display the help box on the screen.
- 18 EPG**
Electronic Program Guide button displays the TV/Radio Program guide.
- 19 RCL (Recall)**
Press to select the channel that was previously viewed.

- Please note : The design of Remote Control Unit may be changed without notice in advance.

Guide of Functions



Information Box (I-Plate)

The details of Service Part and Event Part are automatically displayed on the I-Plate when pressing the () button or changing services. I-Plate is divided into Service Part and Event Part.

SERVICE-PART (Left side of the box)

Service Part consists of the following item :

- I-Plate icon, Current Time
- Service Name, Service Number,  icon
- Subtitle, Teletext, Scrambling Service Symbol (These are automatically displayed when the broadcasting station provides appropriate information.)
- Signal Quality Bar

EVENT-PART (Right side of the box)

EVENT PART consists of the following items:

- Event name, Event duration time
- Description of event, State of reserved event

Event Part shows the current and next event information.

- ▶ button : Use to move from the current event information to the next event information.
- ◀ button : Use to move from the next event information to the current event information.

When the Help() button is pressed under I-Plate display, the help window will appear on the screen.

The Help window shows the extended current event information, including: Satellite Name, Frequency, Polarization, Symbol Rate, FEC... The detailed information for the event can be displayed by pressing the Help() button in the I-Plate with event data displaying mode.

You can reserve the program in the event data display mode by using the White() button.



When the current data is displaying on the screen, you can reset timer program Once, Daily or Weekly mode.

When you release the timer program mode, then you will be asked to confirm the action.

Volume Control

To adjust the volume level, use the  buttons or  buttons.

To temporarily stop the volume, press the Mute() button.

To cancel Mute, press the Mute() button again or press the  buttons or  buttons.

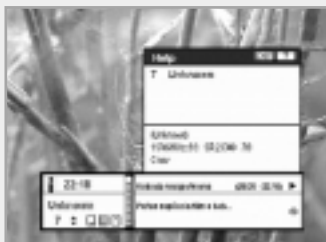

Changing Services

To change services, do in the following sequence:

1. Press the Number buttons(0~9) on the remote control.
2. Press the \odot / \ominus buttons or \blacktriangle / \blacktriangledown buttons.
Or press the Recall(\odot), Service-List(\odot), EPG(\odot)button.
To switch between TV and Radio services, press the TV/Radio (\odot)button.
To select the previous viewed service, press the Recall(\odot)button.

Soundtrack

When you want to watch the Audio Language of soundtrack under servicing, press the Soundtrack(\odot)button firstly.
The on-screen menu is displayed on the top to left side of the screen.

To change the audio language:

1. \blacktriangleleft / \blacktriangleright buttons : Use to select the Audio on the left, right or both.
2. \blacktriangle / \blacktriangledown buttons : Use to select the audio language you want.
3. \odot , \odot button : When this button is pressed, the menu screen will disappear keeping the selected audio soundtrack constant.

When the current service is switched, the audio language returns to the audio language that was selected in previous service. If the returned audio language is invalid, the audio language that you selected from the audio language menu has the priority of playback.

Teletext

Use your TV remote control unit to control the Teletext service.
The teletext button doesn't exist on the STB remote control unit.
When the service supports Teletext, the Teletext icon(\boxtimes) is displayed on the i-plate.



Guide of Functions

Service List

To select the desired service in the service list, you should firstly display the service list using **(OK)** button. Use **▲/▼/◀/▶** buttons to select a service and press **(OK)** button. Also use **(P+)/(P-)** buttons to select a service directly in the service list.

The Service List consists of Service All and Service Favorite. On the Service List, you can change the attributes of a service through the Service Configuration.

▲/▼ button : Use to move to the previous or next service

◀/▶ button : Use to move to the forward or backward service (maximum 6 services).

Red button **(I)** : Service All

Green button **(◀▶)** : Service Favorite



Service Configuration

To change the attributes of a service.

1. Use the **▲/▼/◀/▶** buttons to move a service you want to change in the Service All or Service Favorite mode.
2. Press the Menu **(MENU)** button.
3. Use the **▲/▼** buttons to move to an item (such as favorite, lock, skip, delete) you want on the Service Configuration screen.
4. Use the **◀/▶** buttons to select. Press the **(OK)** button to complete.

Service All

1. To display the service list, press the **(OK)** button. Use Red **(I)** button to select the Service All List.
2. Select the desired service by using the **▲/▼/◀/▶** buttons.
3. Press the **(OK)** button to view the selected service.

The right side scroll-bar of the screen displays the location of the selected service in relation to All Services.

Service Favorite

1. To add the services to the Service Favorite, use the Service Configuration at Service All or Service Organizing menu.
2. When you press the Green **(◀▶)** button in the Service List, the favorite service list will be displayed on the screen.
3. When you want to see the services added to the favorite group, use the **▲/▼/◀/▶** button.

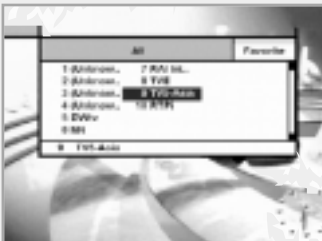

Guide of Main Menu

1. TV Guide

Your STB has an Electronic Program Guide (EPG) to help you navigate through all the possible viewing options. The TV Guide supplies information such as program listings and start and end times for all available services. In addition, detailed information about the program listings and start and end times for all available services. In addition, detailed information about the program is often available in the EPG (the availability and amount of these program details will vary, depending on the particular broadcaster).

2. Parental Control

Access to services and programs is controlled by a PIN Code (i.e., a 4-digit secret code that is defined by the user). The very first time you attempt to lock all services(or lock programs by ratings), the on-screen menu will instruct you to assign a PIN Code (Later on, if necessary, you can change it).

3. Installation

The Installation mode allows you to have the information of setting services and newly set services (language, time, organize, search,..) Furthermore, you can recognize the states of hardware and software versions and signals from your STB.

4. Utility

This menu provides Calendar and Biorhythm.



Guide of Main Menu

1. TV Guide

You can watch a program being shown and reserve it in the TV Guide mode.

To enter the TV Guide mode

Press the EPG(EPG) button on the remote control unit or select the TV Guide on the Main Menu.

To select the TV/Radio Guide

Press the (R) button on the remote control unit and TV Guide will be switched to the Radio Guide.

TV Guide mode includes four different modes.

To select each mode, use the following buttons:

- Red (I) button : Use to display the current or next program list.
- Green (G) button : Use to display the program list for one-week.
- Yellow (Y) button : Use to display the reserved program list.
- Blue (B) button : Use to display the simple TV Guide list.(Quick mode)

NOW / NEXT mode

Show the informations of the program that are played now or will be played next time.

This mode consists of the service name, event name, event duration time, current time and on-screen-display window.

To watch a program you want through the display window :

- Use the (P+)/(P-) buttons to select a program you want.
The selected service will appear on the right display window.
- Use the ▲/▼ buttons to select a program you want.
And then press the (OK) button on the remote control unit.
The selected service will appear on the right display window.
The selected OSD will be highlighted every time the cursor moves.

To reserve a program you want :

- Select a program you want by using the (P+)/(P-) buttons or ▲/▼ buttons. And then press the White (W) button.
Press the ◀/▶ buttons to watch the program of previous page or the program of next page.
Press the Yellow (Y) button to watch the reserved program list.



Weekly mode

Shows the information of programs that will be played for a week. Select a day you want using the ◀/▶ buttons. To watch and reserve a program you want, do the same steps with the NOW/NEXT mode.



Reserved mode

Shows the program lists that you have already reserved on the TV Guide or Information Box. Maximum twenty programs can be reserved. This program list includes service name, date, duration time, reservation mode and event name. To cancel the Reserved service, select a program you want to cancel using the ▲/▼ buttons and then press the White(Ⓢ)button.

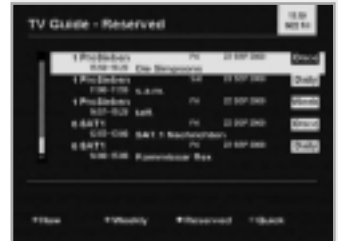

Quick mode

Shows a simple TV Guide like an Information box. This mode shows in the A/V playback mode.

- Blue vertical line : Indicates the current time.
- Black/white bar : Shows the proceeding state of program.
- Time range of bar : This consists of three blocks by 30 minutes per block.

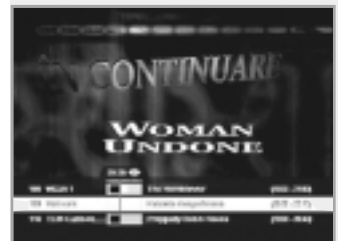

Guide of Main Menu



2. Parental Control

You can set a parental guidance rating to each program in this mode.

1. When the **(OK)** button is pressed after selecting the highlighted parental control on the initial menu screen, a display window for entering the PIN Code will appear on the center of screen.
** The default PIN Code is **0000**.
2. Enter the PIN Code on the display window.
(If any problem occurs when entering a PIN Code, you cannot switch to the next mode.)
3. Set the parental guidance rating of highlighted censorship classification.
Classification: no block or total block.
Enter the PIN Code to unlock or lock programs.
4. To change your PIN Code:
Select the highlighted Old Pin Code using the **▲/▼** buttons and then enter your Old PIN Code.
Enter a New PIN Code in the highlighted new PIN Code using the **▲/▼** buttons.
To verify the New PIN Code, re-enter a new PIN Code in the highlighted Verify Changed PIN Code.
5. When the entered PIN Code is correct, then all settings are completed. (If the PIN Code is wrong, the message "PIN Code mismatch" will be displayed on the display window. When the **(OK)** button is pressed at this time, the old PIN Code is valid and the cursor is located in the first position of this menu.)

3. Installation

This mode allows you to customize, add a new service and displays the state of the STB. Enter the submenus after selecting the Installation Mode in the Main Menu.

3-1. System Setting

The System Setting mode supports the STB internal settings according to the connection of the receiver and external units. This mode includes Language Setting, Time Setting, A/V Output Setting, VHF Tuning and Other Setting.

Language Setting

Select the language for Menu, Audio or Subtitle.

1. Select the highlighted Language Setting using the ▲/▼ buttons in the System Setting mode and then press the (OK) button.
2. Select the highlighted Menu(or Audio, Subtitle) Language and press the ◀/▶ buttons and the language list will be displayed.
3. Use the ▲/▼ buttons to move to a language you want and then press the (OK) button to finish setting.

Menu Language

Select a language for the menu or banner OSD in this mode. Only English is provided.

Audio Language

Select the Default Language for audio when changing services. If you change the current service, your STB will initially select the previously memorized Audio Language. If the Audio Language of current service is not provided, at this time, you should reselect a language on the Audio Language menu.

Languages provided:

Chinese, Czech, Danish, Dutch, English, Finnish, French, German, Greek, Hungarian, Italian, Portuguese, Rumanian, Russian, Spanish, Swedish, Turkish and more.

If no language is provided, then the default language of current service will be automatically selected.

Subtitle Language

Select the Default Language for Subtitle when changing services. Language provided:

Chinese, Danish, English, Finnish, French, German, Italian, Norwegian, Portuguese, Spanish, Swedish and more.



Guide of Main Menu

Time Setting

You can set the Current Time and Wakeup Time in this mode. Furthermore, the Service Number in the Wakeup Time mode and Sleep Time (standby mode) can be set. When a VCR is connected, recording can be automatically done according to Wakeup/Sleep Time Setting.



Current Time

To set the Current Time, enter the Offset value using the standardized information of current service area. The time setting will be used as the standardized time for the I-Plate, TV Guide, Wakeup and Sleep timer.

Time Offset

Current time is based on TDT (Time and Data Table) at the stream of the current service.

Wakeup Time

Select the time when STB is turned on. Use the Number buttons(0~9) on the remote control unit to enter your Wakeup Time.



Wakeup Service No.

Use the ◀/▶ buttons to set the service number provided for the set Wakeup Time. Use the TV/Radio(Ⓟ)button on the remote control unit to toggle TV/Radio service.

Service Name

The Service Name that has been determined by the Wakeup Service No. will be shown.

Sleep Time

Depending on Time Setting, select the time when STB is turned off.

A/V Output Setting

Audio Output

Set the Audio mode which is output from RCA/Cinch Jack. (Stereo/Mono)

Screen Mode

Select the aspect ratio of TV which is connected to STB (4:3 or 16:9).

Display Format

Select the format which the video is to be displayed on screen. When your TV set is 4:3 and video source is 16:9, STB will display in Letter-box or Center mode as selected. When your TV set is 16:9 and video source is 4:3, STB will display in the Pillar-box or Full mode as selected.

NTSC Mode

Adjust this value between 3.58 and 4.43 if your TV displays the video only in black and white color. Normally NTSC 3.58 mode is used worldwide, but some TV sets can support only NTSC 4.43 mode.

VHF Tuning

When you watch TV after connecting a cable between the RF OUT jack on STB and the Input jack (RF Input) on TV. If you select Channel 3 or Channel 4 and then set VHF Tuning to Channel 3 or Channel 4, all services from STB will be viewed through TV Channel 3 or Channel 4.

Other Setting

Select the OSD transparency and Information Box Display Time.

OSD Transparency

Select the OSD transparent type. It affects Information Box, Soundtrack, Subtitle, Service List, Time and Quick mode of TV Guide. Use the ◀/▶ buttons to toggle transparent and opaque.

Info. Box Display Time

Set the display duration of Information Box displayed on the screen after changing services. The time ranges from 0 to 20 seconds.



Guide of Main Menu

3-2. Service Organizing

This menu gives users access to options that allow them to organize their Networks, TV services and Radio services.

** The default PIN Code is **0000** .

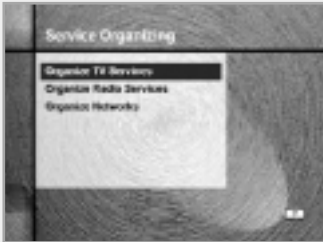



Organize TV Services

Organize services that are included in memory for TV.

Organize All Services

Delete, Move, Lock, Skip or Rename each TV service on all TV service list.



• Delete

1. Use the ▲/▼ buttons to select a service you want to delete.
2. When the Red()button is pressed, the service will be colored in gray.
3. When the  button is pressed, the message “Saving changed Service Information” will appear on the center of screen and simultaneously the service will be deleted.

If you don't want to delete, then press the  button.

If the message “Do you want to save?” appear on the center of screen, press the  button.



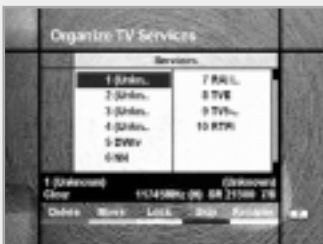

• Move

1. Use the ▲/▼ buttons to select a service you want to move.
2. When the Green()button is pressed, the icon() will appear in front of the service number.
3. Use the ▲/▼/◀/▶ buttons to move to the location you want to use.
4. When the  button is pressed, the message “Saving changed Service Information” will appear on the center of screen and simultaneously the location of service will be changed.







If you don't want to move, press the  button.





- **Lock**

1. Use the ▲/▼ buttons to select a service to be locked by your PIN Code.
2. Press the Yellow()button and the symbol () will be displayed next to the service name.
3. Press the  button and the message “Saving changed Service Information” will appear on the center of screen and simultaneously the selected service will be locked.
If you don't want to lock, then press the  button on the remote control.
If the message “Do you want to save?” appears on the center of screen, then select  .
To watch the locked service, be sure to enter your registered PIN Code.

- **Skip**

1. Use the ▲/▼ buttons to select a service you want to skip.
2. Press the Blue()button and the symbol() will appear next to the service name.
3. Press the  button, and the message “Saving changed Service Information” will appear and simultaneously the selected service will be skipped.
If you don't want to skip, then press the  button.
If the message “Do you want to save?” appears on the center of screen, select  .
When the ▲/▼ buttons or /  buttons are used to select channels, the skipped service channels will not be shown.
To watch the skipped service channels, use the Number buttons(0-9), Service List or the EPG mode.

- **Rename**

1. Use the ▲/▼ buttons to select a service you want to rename.
2. Press the White()button and the keyboard image will appear on the center of screen.
3. Use the ▲/▼/◀/▶ buttons to select a new name and then press the  button.
4. Press the Yellow()button to finish renaming.



Guide of Main Menu

Organize Favorite Services



Delete, Move, Lock, Skip or Rename each TV service in a favorite TV group and re-group them into your favorite TV group. This mode has the same operating methods as "Organize All Services".

Moving the favorite group from the service group:

1. Press the ► button to move to "Services"-Plate (right window).
2. Use the ▲/▼ buttons to select a service channel you want to move.
3. Press the (OK) button and the selected service channel will be moved to "Favorites"-Plate (left window).
4. To finish this menu:
 - Press the ◀ button to move to "Favorites"-Plate (left window).
 - Press the (OK) button and the message "Saving changed Service Information" will appear on the center of screen. Press the (EXIT) button and the message "Do you want to save?" will appear on the center of screen. At this time, press the (OK) button.

note :

1. ▲/▼ buttons : Use to move services and favorite window.
2. (P+)/(P-) buttons : Use to move to the previous page and the next page.



Organize Radio Services

Same functions as "Organize TV Services"

Organize Networks

You can edit services using the network unit. The network names are displayed on the left side of screen, and the TV/Radio Services included in the highlighted network are displayed on the right side of screen. Only the Delete, Rename Function can be used in this mode.

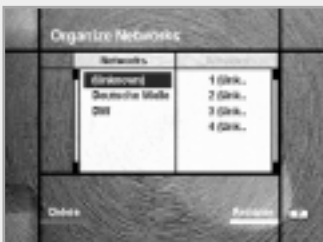

3-3. Service Searching

Search for new services.

This mode includes Antenna Setting and Manual Search.

Antena Setting

Select LNB parameters and switching connections.

Antena Alternative

Use the ◀/▶ buttons to select an antenna number for the required satellite. Antenna alternative 16 is fixed for SMATV and its name can't be changed.

Satellite Name

Selects the satellite name that corresponds to the value of the Antenna Alternative.

Press the ◀/▶ buttons and the satellite names you can memorize will be listed on the screen.

Use the ▲/▼ buttons to select a satellite name and then press the  button.

This name will help you Select Antenna Alternative In Manual Search menu.

note : Press User defined and the keyboard image will appear on the screen. Then you can enter satellite names.

LNB Frequency

Use the ◀/▶ buttons to select a LNB frequency or type on the dish. You can select the LNB Frequency.

If the required LNB frequency is not available, then press the Number buttons(0~9) on the remote control.

22KHz Tone

Use the ◀/▶ buttons to select the antenna tone switch when LNB Frequency is universal.

22KHz tone will be switched automatically.

DiSEqC Input

Use the ◀/▶ buttons to select a DiSEqC antenna switch type. (according to the option and location of DiSEqC switch)

- Type : Disabled, Tone Burst A to B, DiSEqC A, DiSEqC B, DiSEqC C, DiSEqC D



Guide of Main Menu



Manual Search

Find the services manually in the transponder you select.
This search mode included normal advanced and SMATV search.

Antena Alternative

Use the ◀/▶ buttons to select an antenna number for the required satellite. The satellite name will help you select antennas.
If you want to search in SMATV mode, then select the Antenna Alternative 16.

Frequency

Use the ◀/▶ buttons to enter the Frequency of the transponder you want to find (MHz). Or use the Number buttons(0~9) on the remote control.

Polarization

Use the ◀/▶ buttons to select the Polarization of the transponder.
Horizontal : 18 V are output through LNB line
Vertical : 13.5 V are output through LNB line

System Rate

Inputs the Symbol Rate of the transponder you want to find.

FEC (Forward Error Correction)

Use the ◀/▶ buttons to select the Forward Error Correction of the transponder. You can select the value of auto, 1/2, 2/3, 3/4, 5/6 and 7/8.

Network Search

Select "Yes" and you can find more services using the home network.

Automatic Skip

If you want to find free services, then select "Yes".
The scrambled services will not be automatically stored.

Advanced

Press the **OK** button to find services using PIDs and more items for selecting PIDs will be displayed. Press the **OK** button and Video, Audio and PCR PID items will be added. Enter the PID values for Video, Audio and PCR. When the Number buttons(0~9) are pressed, a hexadecimal table will be displayed. Then you can't enter the PID values using the keyboard.

3-4. Status

Display the STB manufacture information and the signal status bar graphic.

STB Status

Display the STB manufacture information. H/W version, S/W version, Date and so on.

Signal Decion

This menu will help the satellite dish be aligned up to 100% Signal Level and Quality.

STB Upgrade

You can download and upgrade the software of this STB via ASTRA 1 satellite when the software of new version is released. Do not turn off the STB during downloading. When the power is switched OFF, turn on the STB and the process will be continued.

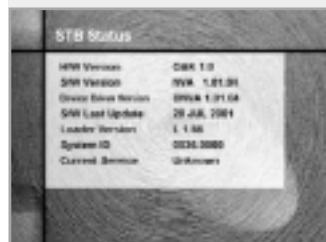
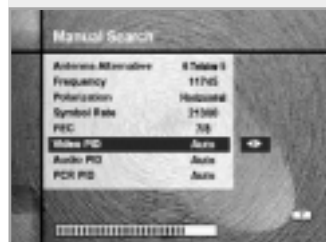

Guide of Main Menu

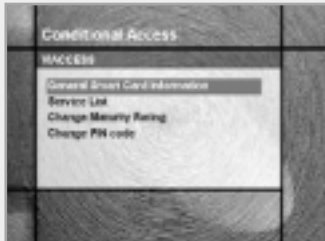

3-5. Conditional Access (for Viaccess Embedded)

This menu allows the user to view the information on the Smart Card and Viaccess conditional access system such as general Smart Card Information, Service List, Change Maturity Rating, Change PIN Code.

General Smart Card Information

You can see the Unique Address, so user Address, Current Maturity Rating of the Smart Card.



Service List

Services or Bouquets are encrypted by Viaccess and operators name, like TPS or ABSat, are displayed on the TV screen. To get more detailed information of viewing rights of services or Bouquets, press **OK** button.

Change Maturity Rating

The STB is required by Viaccess to include a parental control facility for the viewing of restricted services. This can be set to "No block" or for ages ranging from 4 to 18. The correct PIN Code is required to change this option.

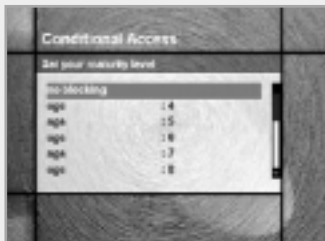

Change PIN Code

When you buy a new Smart Card, the initial PIN Code is set to "NULL". Therefore, it is recommended that this PIN Code should be changed.

This PIN Code is available only on Conditional Access Menu. Enter this PIN Code to see the blocked Viaccess services.

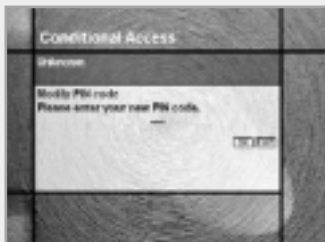

3-6. Default Setting

Reset STB to the default start set in the factory.
Enter the PIN Code " **0000** " and the message "The default values are restored" will appear on the center of screen.
If you want to restore again, select "OK". Otherwise, select "EXIT".

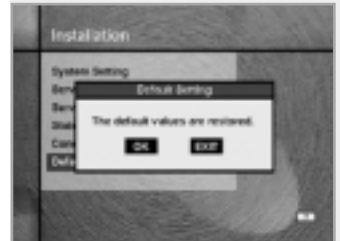

4. Utility

STB supports additional functions such as Calendar and Biorythm.

At the Biorhythm use the ▲/▼/◀/▶ buttons to adjust your birth year and date to see your current biorhythm status.

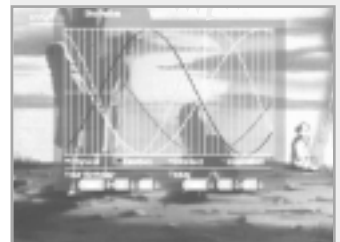

Troubleshooting Guide

Problem	Solution
About STB	
Does not display any LED on the front panel or STB has no power.	<ul style="list-style-type: none"> • Check the main power cable and check that it is plugged into a suitable power outlet. • Check whether STB is in Standby mode.
No Picture	<ul style="list-style-type: none"> • Ensure that the STB is switched on (see above). • Check the video output port (RCA/RF) is firmly connected to the TV or VCR. • Check that you have selected the correct channel or Video Output on your TV. • Check the brightness level of the TV.
Poor picture quality	<ul style="list-style-type: none"> • See "No Picture" above. • Check the signal level, if this is low then try adjusting the alignment of your dish.
No Sound	<ul style="list-style-type: none"> • See "No Picture" above. • Check the volume level of the TV and STB. • Check the Mute status of the TV and STB.
Remote Control does not operate	<ul style="list-style-type: none"> • Point remote control directly towards the STB. • Check and replace batteries.
On-Screen Error Messages	
No or Bad Signal	<ul style="list-style-type: none"> • Check the LNB - replace LNB if necessary. • Check the cable from the LNB. • Check the position of the dish - realign dish if necessary. • If you are using a DiSEqC 1.0 switch, check that you have connected the LNBs to the correct connections on the switch. • Check the "Signal Level" and the "Signal Quality" in the Signal Status menu.
Service Search	
"No Signal" in manual search	<ul style="list-style-type: none"> • Check the "Signal Level" and the "Signal Quality" in the Signal Status menu. • Check the LNB - replace LNB if necessary. • Check the cable from the LNB. • Check the position of the dish - realign dish if necessary. • DiSEqC 1.0 Check that you have connected the LNBs to the correct connections on the switch. Check that you have set the connected setting in the Antenna Setting menu.

Problem	Solution
LED Error Message	
Amber only: Invalid system ID	<ul style="list-style-type: none"> • Check whether the system ID is different for Software and STB.
Amber & Red: Incorrect data block CRC error	<ul style="list-style-type: none"> • You need to contact your retail shop.
Amber & Red & Green: Incorrect application CRC error	<ul style="list-style-type: none"> • You need to contact your retail shop.

- If you can't solve the problem even referring this Troubleshooting Guide, contact us via our homepage.

Homepage : <http://www.humaxdigital.com>

Menu Map

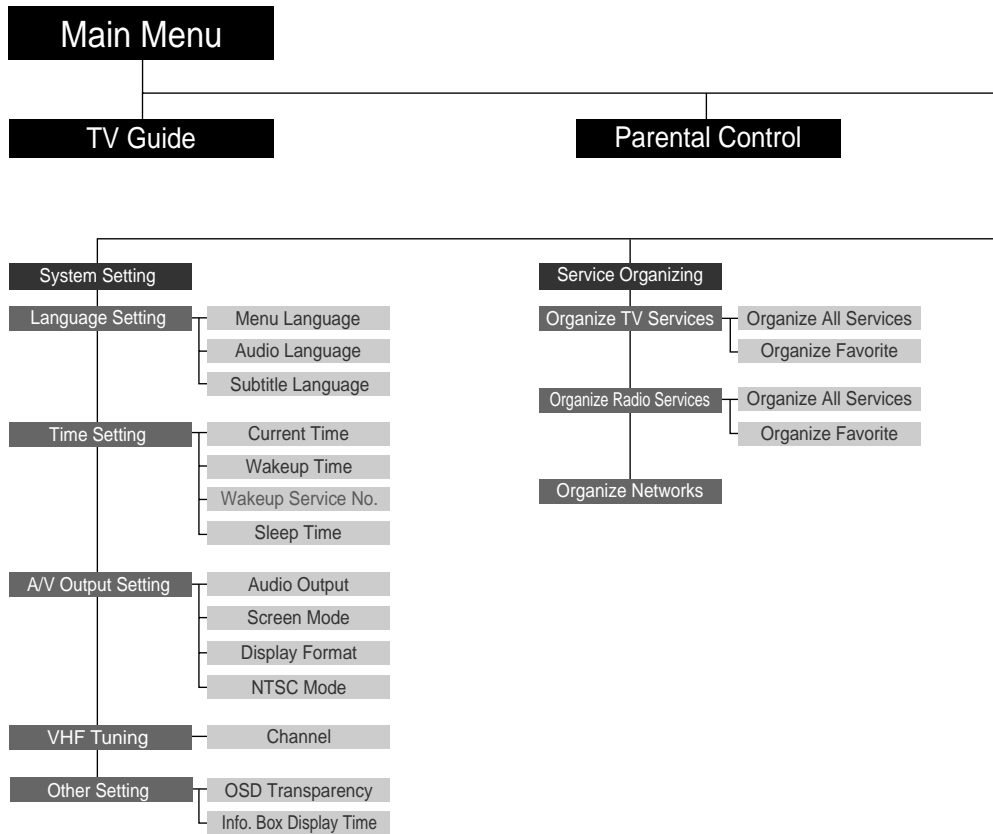

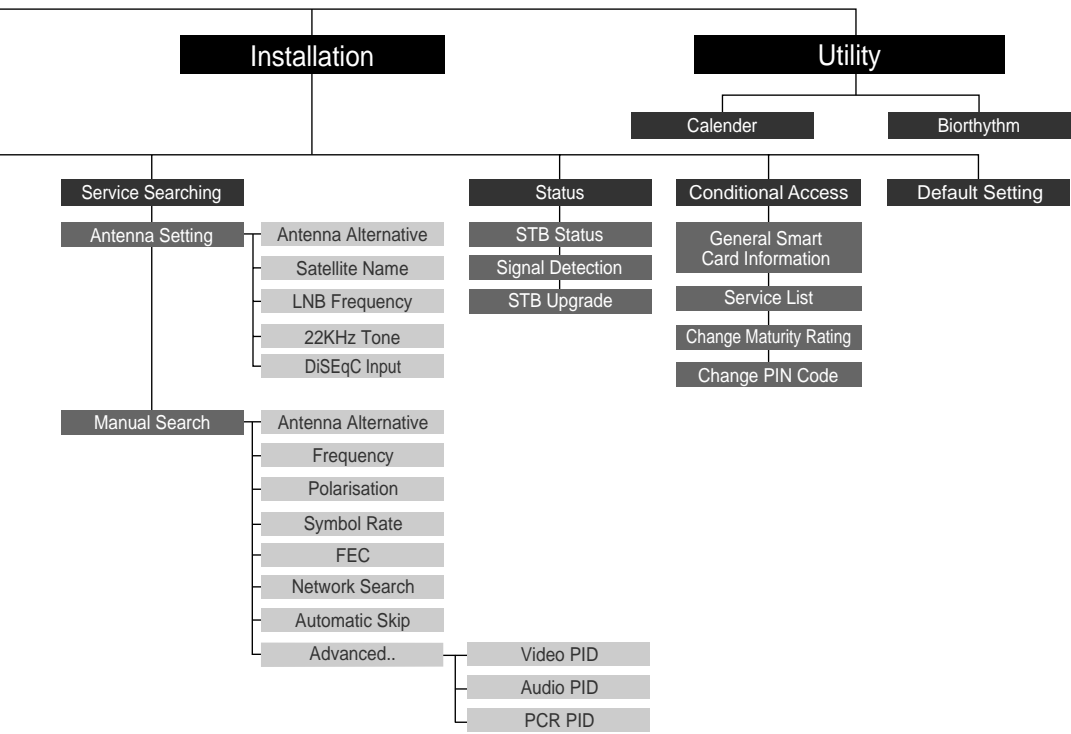

Specification

Conditional Access Interface

Viaccess Embedded	1 Slot Smart Card
-------------------	-------------------

Tuner & Channel

Input Connector	F-type, IEC 169-24, Female
Frequency Range	950 MHz to 2150 MHz
Input Impedance	75Ω unbalanced
Signal Level	-25 to -65dBm
IF	480 MHz
IF Band width	36 MHz
LNB Power & Polarisation	Vertical : +13.5V Horizontal : +18V Current : 500mA Max. Overload Protection
22 KHz Tone	Frequency : 22 ± 4KHz Amplitude : 0.6 ± 0.2V
DiSEqC Control	Version 1.0/1.2 Compatible
Demodulation	QPSK
Input Symbol Rate	2-31 Ms/s
FEC Decoder	Convolutional Code Rate 1/2, 2/3, 3/4, 5/6 and 7/8 with Constraint Length K=7

MPEG Transport Stream A/V Decoding

Transport Stream	MPEG-2 ISO/IEC 13818 Transport stream specification
Profile Level	MPEG-2 MP@ML
Input Rate	60 Mbit/s Max
Aspect Ratio	4:3, 16:9
Video Resolution	720 x 576
Audio Decoding	MPEG/MusiCam Layer I & II
Audio Mode	Single channel / Dual channel / Joint stereo / Stereo
Sampling	32, 44.1 and 48KHz

Memory

Main Processor	TMIPS R3930(81MHz)
Flash Memory	3Mbyte
Graphic(MPEG) & System DRAM	4Mbyte

A/V & Data In/Out

VIDEO	RCA/Cinch
AUDIO R/L	RCA/Cinch Volume and Mute Control (Resolution : 20 bits DAC, Max. 2 Vrms)
RS-232C	Transfer rate 115,200 bps, 9pin D-sub Type
S-VIDEO	Y-C separated Video output for High Quality

RF-Modulator

RF-Connector	75Ω, IEC 169-2, Male / Female
Frequency	61.25 MHz, 67.25 MHz
Output Channel	CH3, 4 for the Remodulator
TV Standard	NTSC-M
Preset Channel	CH3. Software changeable by Menu.

Power Supply

Input Voltage	100 - 250V AC, 50/60 Hz
Type	SMPS
Power Consumption	Max. 30W
Standby Power	≤ 8W
Protection	Separate internal fuse. The input shall have lightening Protection

Physical Specification

Size (W x H x D)	260 x 50 x 180 mm
Weight (Net)	Around 1.3 kg
Operating Temp	0°C to + 45°C
Storage Temp	-10°C to + 70°C
Storage Humidity	5% ~ 95% RH (Non-Condensing)

- **Please note** : The specification of the STB may be changed without notice in advance.

HTVA3210.700

Free Manuals Download Website

<http://myh66.com>

<http://usermanuals.us>

<http://www.somanuals.com>

<http://www.4manuals.cc>

<http://www.manual-lib.com>

<http://www.404manual.com>

<http://www.luxmanual.com>

<http://aubethermostatmanual.com>

Golf course search by state

<http://golfingnear.com>

Email search by domain

<http://emailbydomain.com>

Auto manuals search

<http://auto.somanuals.com>

TV manuals search

<http://tv.somanuals.com>