

Matrix™ 47 Operations Manual

531338-1_A



Matrix™
FISHING SYSTEM

Thank You!

Thank you for choosing Humminbird®, America's #1 name in fishfinders. Humminbird® has built its reputation by designing and manufacturing top-quality, thoroughly reliable marine equipment. Your Humminbird® is designed for trouble-free use in even the harshest marine environment. In the unlikely event that your Humminbird® does require repairs, we offer an exclusive Service Policy - free of charge during the first year after purchase, and available at a reasonable rate after the one-year period. For complete details, see the separate warranty card included with your unit. We encourage you to read this operations manual carefully in order to get full benefit from all the features and applications of your Humminbird® product.

Contact our Customer Resource Center at either 1-800-633-1468 or visit our website at www.humminbird.com.

WARNING! This device should not be used as a navigational aid to prevent collision, grounding, boat damage, or personal injury. When the boat is moving, water depth may change too quickly to allow time for you to react. Always operate the boat at very slow speeds if you suspect shallow water or submerged objects.

WARNING! Disassembly and repair of this electronic unit should only be performed by authorized service personnel. Any modification of the serial number or attempt to repair the original equipment or accessories by unauthorized individuals will void the warranty. Handling and/or opening this unit may result in exposure to lead, in the form of solder.

WARNING! This product contains lead, a chemical known to the state of California to cause cancer, birth defects and other reproductive harm.

Fish ID+™, FishingGPS®, Humminbird®, Matrix™, RTS®, SmartCast®, Structure ID®, Total Screen Update®, WeatherSense®, WhiteLine®, and X-Press™ Menu are trademarked by or registered trademarks of Humminbird®.

© 2004 Humminbird®, Eufaula AL, USA. All rights reserved.

Table of Contents

How Sonar Works	1
3D Sonar	2
2D Sonar	2
What's On the Display (3D View)	3
What's On the Display (2D View)	5
Views	7
3D Sonar View	7
3D/2D Sonar Combo View	9
6-Beam Sonar View	10
2D Sonar View	11
Real Time Sonar (RTS®) Window	12
2D Zoom View	13
2D Big Digits View	14
Bottom Presentation	15
Key Functions	17
POWER/LIGHT Key	17
VIEW Key	17
MENU Key	17
4-WAY Cursor Control Key	18
EXIT Key	18
Accessory Bus	19
Powering Up the Unit	19
The Menu System	20
Start-Up Options Menu	22
Normal Operation	22
Simulator	23
System Status	23
PC Connect (with PC Connect Cable Only)	24

Table of Contents

Sonar X-Press™ Menu	25
3D Bottom Zoom (3D Sonar, 3D/2D Sonar Combo Views Only)	26
3D Lower Range (3D Sonar, 3D/2D Sonar Combo, 6-Beam Sonar Views Only)	26
3D History (3D Sonar, 3D/2D Sonar Combo Views Only)	27
2D Sonar Window (3D/2D Sonar Combo View Only)	27
Reset View (3D Sonar, 3D/2D Sonar Combo Views Only)	27
6-Beam Sensitivity (6-Beam Sonar View Only)	28
Sensitivity (2D Sonar, 2D Zoom, 2D Big Digits Views Only)	28
Upper Range (Advanced: 2D Sonar, 2D Big Digits Views Only)	29
Lower Range (2D Sonar, 2D Zoom, 2D Big Digits Views Only)	30
Chart Speed (2D Sonar, 2D Zoom, 2D Big Digits Views Only)	31
Bottom View (2D Sonar, 2D Zoom, 2D Big Digits Views Only)	31
Zoom Level (2D Zoom View Only)	32
Sonar Menu Tab	33
3D Bottom Style	34
3D Frame Style	34
Beam Select	34
Fish ID+™	35
Fish Sensitivity	36
Fish ID 3D Reference	36
Real Time Sonar (RTS®) Window	37
Depth Lines (Advanced)	38
Surface Clutter (Advanced)	39
Noise Filter (Advanced)	39
Max Depth (Advanced)	40
Water Type (Advanced)	40
Alarms Menu Tab	41
Depth Alarm	42
Fish ID Alarm	42
Low Battery Alarm	43
Alarm Tone	43

Table of Contents

Setup Menu Tab	44
Units - Depth	45
Units - Temp (International Only)	45
Units - Distance (with Temp/Speed or GPS Receiver)	45
Units - Speed (with Temp/Speed or GPS Receiver)	46
User Mode	46
Language (International Only)	46
Triplog Reset (with Temp/Speed or GPS Receiver)	47
Restore Defaults	47
Select Readouts (Advanced: 3D and 2D Sonar Views Only)	48
Depth Offset (Advanced)	50
Temp Offset (Advanced)	50
Speed Calibration (Advanced: with Temp/Speed Only)	50
NMEA Output (Advanced)	51
Views Menu Tab	52
Accessories Menu Tab	53
Troubleshooting	54
Matrix™ Doesn't Power Up	54
Matrix™ Defaults to Simulator with a Transducer Attached	54
Display Problems	55
Finding the Cause of Noise	56
Matrix™ Fishing System Accessories	57
Specifications	58
Contact Humminbird®	59

NOTE: Entries in this Table of Contents which list (International Only) are only available on products sold outside of the US and Canada by our authorized International Distributors. To obtain a list of authorized International Distributors, please visit our website at www.humminbird.com or contact our Customer Resource Center at 1-800-633-1468 to locate the distributor nearest you.

NOTE: Entries in this Table of Contents which list (with PC Connect Cable Only) require the purchase of a separate accessory. You can visit our website at www.humminbird.com to order accessories online or contact our Customer Resource Center at 1-800-633-1468.

How Sonar Works

Sonar uses sound waves to determine the presence and location of underwater objects. The time measured between the transmission of the sound wave and the reception of any reflection can be used to determine distance from an object. Analysis of the reflected signal can also be used to determine location, size, or composition of underwater objects.

Humminbird® products consist of two main components: the sonar unit and the transducer. The sonar unit contains the transmitter and receiver, as well as the user controls and LCD display. The transducer is mounted beneath the water surface and converts electrical energy from the transmitter into mechanical pulses or sound waves. The transducer also receives reflected sound waves and converts them back into electrical signals for display on the sonar unit.

The transmit and receive cycle is very fast. A sound wave can travel from the surface to a depth of 240 ft (70 m) and back again in less than ¼ of a second. It is unlikely that your boat can "outrun" this sonar signal.

A number of variables affect the nature of information which can be derived from the sonar return. Sonar signals generated at a higher frequency have the advantage of greatly increased sonar resolution, although the distance (depth) a high-frequency signal can travel is relatively short. A low frequency signal can travel great distances, but provides poor sonar resolution. The shape of the transmitted sonar signal greatly affects the information available as well. A single wide beam has a large area of coverage but poor resolution of detail. A narrow beam has excellent detail, but only a limited area of coverage.

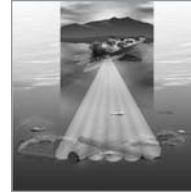

3D Sonar

Your Matrix™ Fishing System uses a six-element transducer that transmits at 455 kHz and is capable of reaching depths of 240 ft (75 m). Each transmitted beam is 16 degrees in width and is symmetrical. The six beams are lined up next to each other to provide a total coverage of 53 degrees from side to side, and 16 degrees from front to back. Using multiple narrow beams together gives you a wide area of coverage for terrain interpretation and fish location, without sacrificing the detail only a narrow beam can provide. Your Matrix™ Fishing System gathers information from a continuous series of these returned signals. It then interprets this information to create a detailed 3-dimensional view of the terrain passing beneath your boat as you travel across the water.



2D Sonar

Your Matrix™ Fishing System also has the capability of displaying traditional 2-dimensional sonar information from either a 455 kHz beam or an 83 kHz beam. The 455 kHz single beam has the advantage of providing increased sonar resolution but is limited to a depth capability of 240 ft (75 m). The 83 kHz single beam sonar has the advantage of providing sonar information to 1000 ft (330 m) but the sonar resolution is not as great as with the 455 kHz single beam.

NOTE: Depth capability is affected by such factors as boat speed, wave action, bottom hardness, water conditions and transducer installation.

What's On the Display (3D View)

In 3D views, your Matrix™ Fishing System can display a variety of useful information about

the area under and adjacent to your boat, including the following items:

Depth - water depth; can be set to alarm when the water becomes too shallow.

Temperature - water surface temperature.

Bottom Contour - Shows the shape of the bottom derived from depth measurements on 6 beams. 3 bottom styles are available; the front edges of the bottom contour are outlined to create a visual anchor. The width of the bottom covered is approximately equal to the depth.

Timer - elapsed time with Temp/Speed Accessory or GPS Receiver.

Distance - distance traveled with Temp/Speed Accessory or GPS Receiver.

Average Speed - average speed reading with Temp/Speed Accessory or GPS Receiver.

Speed - if a Temp/Speed accessory or GPS Receiver is attached, the Matrix can display the speed of the boat, and can keep a Triplog of nautical or statute miles traveled.

Boat/Direction Arrow - A simple, solid 3D boat is drawn when the Upper Depth Range is 0. A solid 3D arrow is drawn when the Upper Depth Range is not 0.

Fish ID+™ - A fish icon will be shown at the derived position of the fish. Six fish icon styles will be used to indicate the primary beam in which the fish was found. Left-facing fish indicate fish off the port side of the boat, while right-facing fish indicate fish off the starboard side. Each fish icon is available in three different sizes. Larger fish icons are used to represent stronger returns. The icons used in the 2D Sonar View are identical to the icons used in the 3D Sonar View.

Upper and Lower Depth Range Labels

Battery Voltage - the voltage of the boat's battery; can be set to alarm if the voltage falls below a certain point.

Frame - provides a reference for bottom and Fish ID information. A Range of frame styles are available, from simple to complex.

NOTE: Entries in this view that list (with Temp/Speed or GPS Receiver) are available if either device is the GPS receiver will be displayed on the view.

connected to the Matrix™ Fishing System. If both devices are connected, then only the information from

What's On the Display (2D View)

In 2D views, your Matrix™ Fishing System can display a variety of useful information

about the area under and adjacent to your boat, including the following items:

Depth - water depth; can be set to alarm when the water becomes too shallow.

Speed - if a Temp/Speed accessory or GPS Receiver is attached, the Matrix can display the speed of the boat, and can keep a Triplog of nautical or statute miles traveled.

Temperature - water surface temperature.

Bait Ball

Timer - elapsed time with Temp/Speed Accessory or GPS Receiver.

Distance - distance traveled with Temp/Speed Accessory or GPS Receiver.

Average Speed - average speed reading with Temp/Speed Accessory or GPS Receiver.

Hard Bottom

Rocky Bottom

Second Sonar Return - when the sonar signal bounces between the bottom and the surface of the water and back again. Use the appearance of the second return to determine bottom hardness. Hard bottoms will show a strong second return, while soft bottoms will show a very weak one or none at all.

Cursor - available in Freeze Frame and can be positioned in the Sonar View to provide depth of a sonar return and bottom depth

Cursor Dialog Box - indicates cursor depth on the display and the depth of the bottom directly below the cursor.

Structure - where fish may be hiding.

Thermoclines - layers of water with different temperatures that appear at different depths and different times of the year. A thermocline typically appears as a continuous band of many gray levels moving across the display at the same depth.

Fish ID+™ - A fish icon will be shown at the derived position of the fish. Six fish icon styles will be used to indicate the primary beam in which the fish was found. Left-facing fish indicate fish off the port side of the boat, while right-facing fish indicate fish off the starboard side. Each fish icon is available in three different sizes. Larger fish icons are used to represent stronger returns. The icons used in the 2D Sonar View are identical to the icons used in the 3D Sonar View.

Soft Bottom

RTS® (Real Time Sonar) Window

Battery Voltage - the voltage of the boat's battery; can be set to alarm if the voltage falls below a certain point.

NOTE: Entries in this view that list (with Temp/Speed or GPS Receiver) are available if either device is connected to the Matrix™ Fishing System. If both devices are connected, then only the information from the GPS receiver will be displayed on the view.

connected to the Matrix™ Fishing System. If both devices are connected, then only the information from

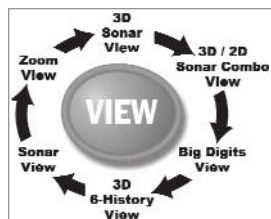

Views

The views available on your Matrix™ Fishing System are:

- 3D Sonar View
- 3D/2D Sonar Combo View
- 6-Beam Sonar View
- 2D Sonar View
- 2D Zoom View
- 2D Big Digits View.

3D Sonar View is the default view. When the VIEW key is pressed, the display cycles through the available views. When the EXIT key is pressed, the display cycles through the available views in reverse order. Any view can be hidden or displayed as part of the view rotation using the Views Menu tab.

NOTE: When you change any menu settings that affect the sonar, the view will update immediately (i.e. you don't have to exit the menu to apply the change to the screen). For instance, by switching between "Inverse" and "Structure ID®" from the X-Press™ Menu it is possible to quickly alternate between the two viewing methods.

NOTE: If the Depth number is flashing, it means that the unit is having trouble locating the bottom. This usually happens if the water is too deep, the transducer is out of the water, the boat is moving too fast, or for any other reason that the unit can't accurately receive continuous data.

3D Sonar View

3D Sonar View displays a 3-dimensional representation of the bottom. Depth is always displayed in the upper left hand corner. Temperature and speed are displayed if the temp/speed paddle wheel is connected or if a GPS receiver is connected. The sonar returns from each of the six elements are combined to create a 3-dimensional wire-frame representation of the bottom. The graphic depiction of the bottom provides you with an effective tool for understanding the terrain beneath the boat. The boat symbol represents the location of your boat in relation to the on-screen information.

The most recent sonar returns are charted on the upper right side of the screen and move to the lower left as new information is received. The width of coverage is approximately equal to the depth. Depth range is automatically selected to keep the bottom visible on the display. In some situations, the selected point of view may prevent the display of some information due to the slope of the terrain. An option is available to change the perspective, or viewpoint,

in order to let you see information that would otherwise be masked by the terrain. Use the 4-WAY Cursor Control key to change the perspective. The perspective can be re-set to the default view by selecting Reset View from the X-Press™ menu.

If a return meets certain criteria one of 18 kinds of fish symbols will be assigned. There are three different size fish symbols to indicate the intensity of the return and each of the six beams has a unique set of fish symbols (see **Fish ID+™** on the **Main Menu Sonar Tab** for more information).

Six additional Digital Readouts display information from optional-purchase accessories. These information boxes can be customized to show only the information desired (see **Setup Menu Tab, Select Readouts**).

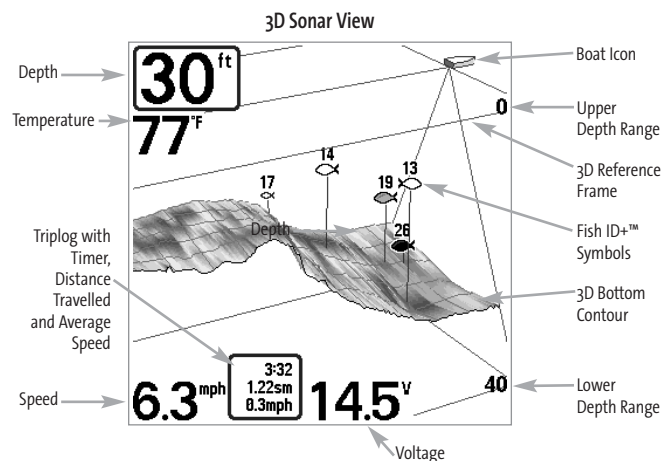

3D/2D Sonar Combo View

3D/2D Sonar Combo View displays a 3-dimensional representation of the bottom next to the traditional 2-dimensional sonar representation. Depth is always displayed in the upper left hand corner. The 3D/2D Sonar Combo View is especially useful for evaluating the bottom terrain from the 3D window while simultaneously viewing the 2D window for structure and bottom hardness. Refer to the *3D Sonar View* and the *2D Sonar View* sections for more information on these views.

The digital readouts in the 3D/2D Sonar Combo View cannot be customized, making information such as water temperature and voltage unavailable in this view.

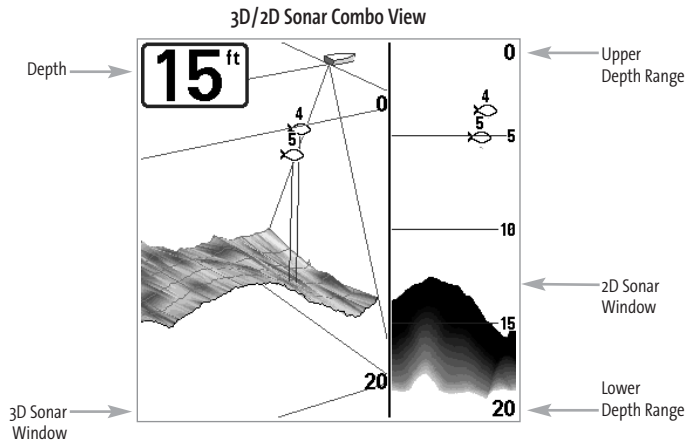

6-Beam Sonar View

6-Beam Sonar View displays information from each of the six 455 kHz beams in a traditional 2D representation. This view displays the raw sonar returns from each of the beams that are used to create the 3-dimensional wire frame representation of the bottom in the 3D Sonar View. The 6-Beam Sonar View can be used for identifying structure on the bottom and sonar returns in the water column. The 6-Beam Sonar View also provides information on sonar targets relative to the boat. The far right window displays sonar targets which are to the far right of the boat and the far left window displays sonar targets which are to the far left of the boat. The remaining windows display sonar targets which are successively closer to the boat. The width of coverage is approximately equal to the current depth.

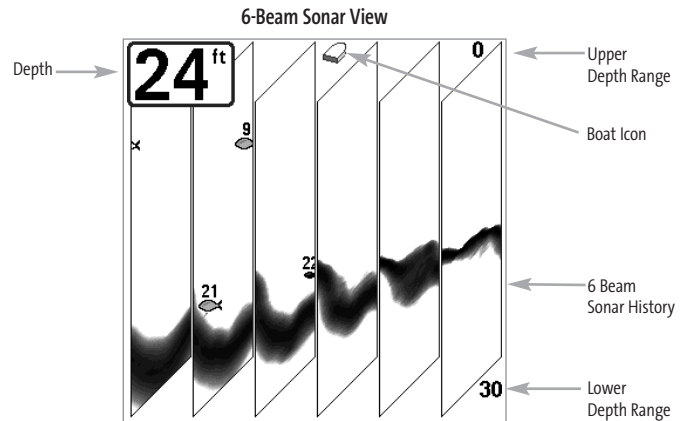

The digital readouts in the 6-Beam Sonar View cannot be customized, making information such as water temperature and voltage unavailable in this view.

2D Sonar View

2D Sonar View is a 2-dimensional view that presents a historical log of sonar returns. Depth is always displayed. Readouts for temperature and speed are automatically displayed if the appropriate accessory is connected. The most recent sonar returns are charted on the right side of the window; as new information is received, the older information is moved across the display to the left. A Digital Depth Readout is displayed in the upper left corner. A scale with Upper and Lower Depth Range readouts appears along the right edge of the Sonar View. The scale indicates the distance from the surface of the water to a depth range sufficient to show the bottom. Depth Range is automatically selected to keep the bottom visible on the display, although you can adjust it manually as well (see *Sonar X-Press™ Menu*). Six additional Digital Readouts display information from optional-purchase accessories. These information boxes can be customized to show only the information desired (see *Setup Menu Tab, Select Readouts*).

When in 2D Sonar View, your unit operates like a typical depthsounder. There are, however, several exceptions. The six-beam 53 degree transducer allows you to search for fish with a much wider area of coverage. Only the two center beams provide sonar returns for the bottom contour shown on the display. The fish symbols shown in the 2D Sonar View are the same as those used in the 3D Sonar View providing information on the location of the fish relative to the boat (see *Sonar Menu Tab, Fish ID+*). Use the 2D Sonar View for identifying structure and bottom hardness.

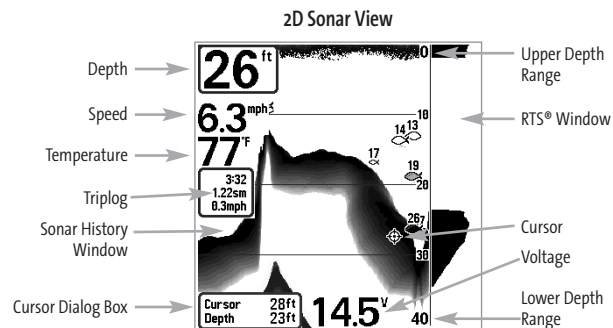

Freeze Frame - Pressing any arrow on the 4-WAY Cursor Control key will freeze the screen in the 2D Sonar View and a cursor will be displayed on the screen. The cursor can be positioned on the display using the 4-WAY Cursor Control key to determine the depth of any sonar return. The RTS® Window continues to update in Freeze Frame. In addition, see the effects of menu setting changes with Instant Image Update. Pressing EXIT will exit Freeze Frame and the display will start to scroll. Freeze Frame is only available in the 2D Sonar View.

Real Time Sonar (RTS®) Window

A **Real Time Sonar (RTS®)** Window appears on the right side of the display in the 2D Sonar View only. The RTS® Window always updates at the fastest rate possible for depth conditions and shows only the returns from the bottom, structure and fish that are within the transducer beam. The RTS® Window plots the depth and intensity of a sonar return (see *Sonar Menu - RTS® Window*).

The **Narrow RTS® Window** indicates the sonar intensity through the use of grayscale. The grayscale used matches the bottom view grayscale setting used in the sonar history window (i.e. Inverse, StructureID®, WhiteLine®, Bottom Black). The depth of the sonar return is indicated by the vertical placement of the return on the display depth scale.

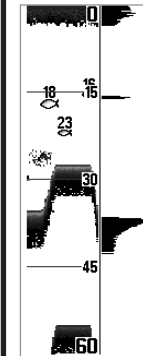
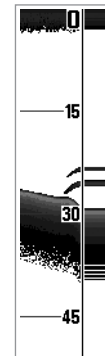

The **Wide RTS® Window** indicates the sonar intensity through the use of a bar graph. The length of the plotted return provides an indication of whether the return is weak or strong. The depth of the sonar return is indicated by the vertical placement of the return on the display depth scale. The Wide RTS® Window does not make use of grayscale.

2D Zoom View

2D Zoom View increases the displayed resolution to separate sonar returns that are very close together, such as those caused by fish suspended close to the bottom or within structure. Digital depth is displayed in the upper left hand corner. In 2D Zoom View, the display is split to show a narrow slice of the full range view on the right and the zoomed view on the left. The full range view on the right also contains the Zoom Preview Box that shows what part of the full range view is shown in zoomed view on the left; the Zoom Preview Box tracks the bottom in the full range view.

As the depth changes, the zoomed view updates automatically to display a magnified image of the bottom. The Zoom Preview Box shows where the zoomed view is in relation to the full range view. The Zoom Level, or magnification, is displayed in the lower left corner and can be changed to suit conditions (see *Sonar X-Press™ Menu: Zoom Level*). Upper and Lower Zoom Depth Range numbers indicate the depth of the water you are viewing.

The digital readouts in the 2D Zoom View cannot be customized, making information such as water temperature and voltage unavailable in this view.

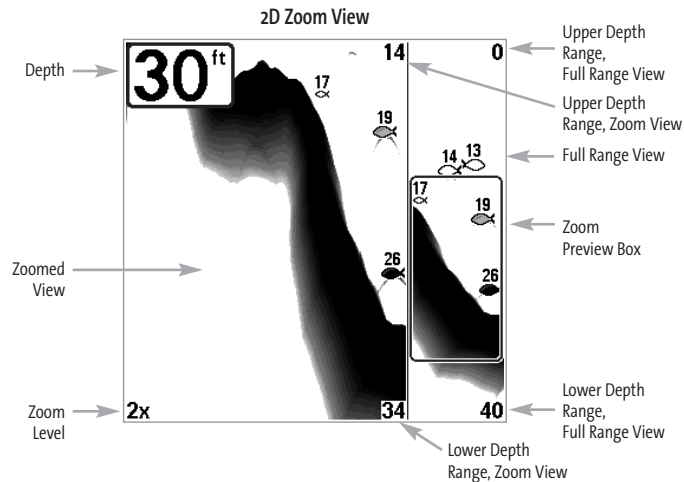

2D Big Digits View

2D Big Digits View provides digital data in a large, easy-to-see format. Depth is always displayed. Readouts for temperature, speed and Triplog information are displayed automatically if the appropriate accessory is connected to the system. The Triplog shows distance traveled, average speed, and time elapsed since the Triplog was last reset. The digital readouts in the 2D Big Digits View cannot be customized.

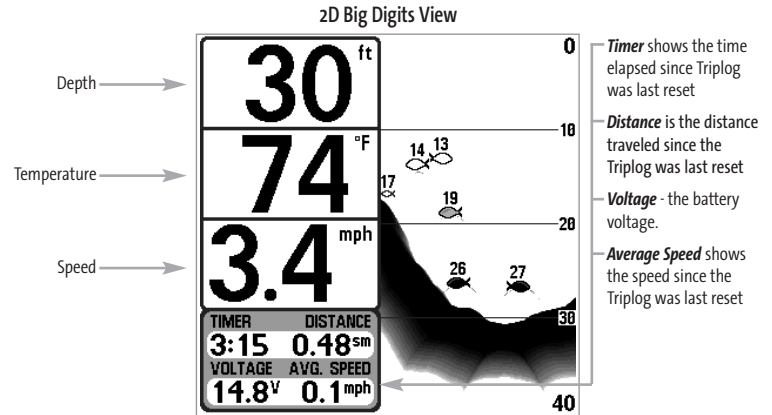

Bottom Presentation

As the boat moves, your Matrix™ Fishing System charts the changes in depth on the display to create a profile of the **Bottom Contour**. The type of bottom can be determined from the return charted on the display. A **Hard Bottom** such as compacted sediment or flat rock appears as a thinner line across the display. A **Soft Bottom** such as mud or sand appears as a thicker line across the display. **Rocky Bottoms** have a broken, random appearance.

Bottom Contour Profile with RTS® Window.
Temp/Speed Accessory is optional.

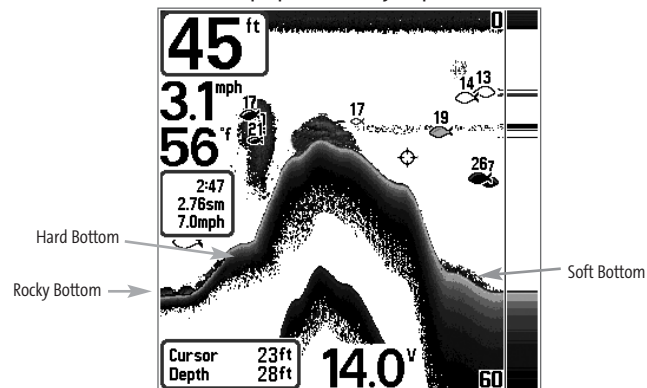

The sonar returns from the bottom, structure and fish can be represented as either **Inverse** (default), **WhiteLine®**, **Structure ID®**, or **Bottom Black**. See *Sonar X-Press™ Menu: Bottom View* for details on how to set the bottom view.

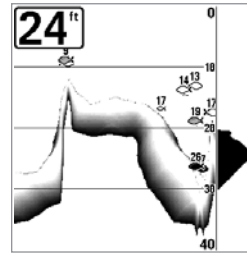

Inverse is a method where weak returns are shown with dark pixels and strong returns with lighter pixels. This has the benefit of ensuring that weak signals will be clearly visible on the display.

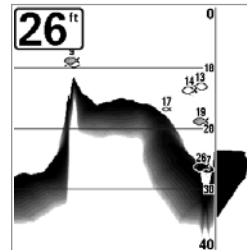

Structure ID® represents weak returns as light pixels and strong returns as dark pixels. This has the benefit of ensuring that strong returns will be clearly visible on the display.

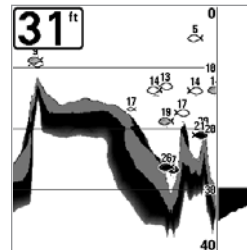

WhiteLine® highlights the strongest sonar returns in white, resulting in a distinctive outline. This has the benefit of clearly defining the bottom on the display.

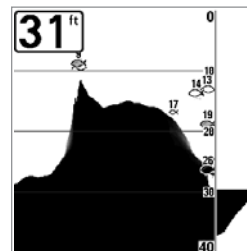

Bottom Black displays all pixels below the bottom contour as black, regardless of signal strength. This has the benefit of providing a high contrast between the bottom and other sonar returns on the display. Any targets such as fish, structure and thermoclines will be shown using the Structure ID® method.

Key Functions

Your Matrix™ Fishing System user interface consists of a set of easy-to-use keys that work with various on-screen views and menus to give you flexibility and control over your fishing experience.



POWER/LIGHT Key

The POWER/LIGHT key is used to turn the Matrix™ Fishing System on and off, and also to adjust the backlight and contrast of the display. Press the POWER/LIGHT key to turn the unit on. The Title screen is then displayed until the Fishing System begins sonar operation.

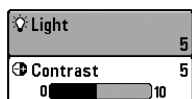

Your Fishing System will start up with the backlight on and will automatically turn it off to conserve power. To turn the backlight on for night fishing, or to adjust the display contrast, press the POWER/LIGHT key to access the Light and Contrast menu. Use the 4-WAY Cursor key to select Light or Contrast and then use the LEFT or RIGHT Cursor key to change the settings. Press EXIT to exit the Light and Contrast menu.

Press and hold the POWER/LIGHT key for 3 seconds to turn the unit off. A message will appear telling you how many seconds there are until shutdown occurs. Your Fishing System should always be turned off using the POWER/LIGHT key. This will ensure that shutdown occurs properly and any menu settings will be saved.



VIEW Key

The VIEW key is used to cycle through all available views. Press the VIEW key to advance to the next view. Repeatedly pressing VIEW cycles through all views available. Views can be hidden to optimize the system to your fishing requirements (see *Views Menu Tab*).



MENU Key

The MENU key is used to access the menu system.

Start-Up Options Menu - Press the MENU key during the power up sequence to view the Start-Up Options menu.

X-Press™ Menu - Press the MENU key once for the Sonar X-Press™ Menu. The X-Press™ Menu allows you to access frequently-used settings without having to navigate through the whole menu system. When the X-Press™ Menu is displayed, you can use the UP or DOWN Cursor keys to move to a particular menu choice. As soon as you alter a parameter (using the RIGHT or LEFT Cursor keys) the X-Press™ Menu will collapse temporarily, and the screen will update if it is affected by your menu setting change, allowing you to see the effects of your action immediately. Reactivate the X-Press™ Menu by using the UP or DOWN Cursor keys.

Main Menu - Press the MENU key twice for the tabbed Main Menu System. The Main Menu System is organized under tabbed headings to help you find a specific menu item quickly: Alarms, Sonar, Setup, Views, and Accessories tabs are part of your tabbed Main Menu System. Use the LEFT or RIGHT 4-WAY Cursor Control key to select a tab; then use the DOWN or UP key to select the menu item, and the LEFT or RIGHT key to alter a menu setting.

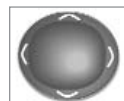

4-WAY Cursor Control Key

The 4-WAY Cursor Control key has multiple functions, depending on the situation:

- Use the DOWN or UP arrow keys to select a menu choice from the menu list,
- Use the LEFT or RIGHT arrow keys to change a menu setting.
- Press any arrow key to activate Freeze Frame while in the 2D Sonar View and then use the 4-WAY Cursor Control key to position the cursor on the display.
- Press any arrow key to change the perspective in the 3D Sonar View. Subsequent presses of the 4-WAY Cursor Control key rotate and tilt the 3D representation.

NOTE: Menu choices are implemented and saved immediately - no further action is required.



EXIT Key

The EXIT key has multiple functions, depending on the situation:

- If an alarm is sounding, pressing EXIT will cancel the alarm.
- If a menu tab is selected, pressing EXIT will exit the menu mode and return to the view.
- If a menu is active, pressing EXIT will return to the previous level in the menu system.
- Pressing EXIT will cycle through the available views in reverse order.
- If Freeze Frame is active, pressing EXIT will return to a scrolling display.

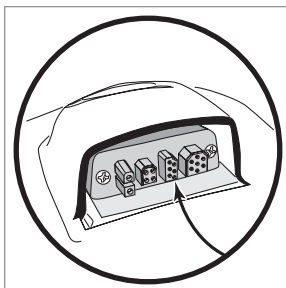

Accessory Bus

Use the Accessory Bus to expand the functionality of the Matrix™ Fishing System. Accessories plug directly into the Matrix™ Fishing System, enabling Advanced features such as WeatherSense®, GPS Functionality and the SmartCast® Wireless Sonar Link. Additional menu tabs and menu choices will be added to the menu system automatically when an accessory is plugged into the unit. In addition, multiple accessories can be attached simultaneously. See *Accessories Menu Tab* and *Matrix™ Fishing System Accessories* in this manual, as well as your accessory's Operations Manual for additional details.

NOTE: Accessories to enable WeatherSense®, GPS Functionality and the SmartCast® Wireless Sonar Link require separate purchases. You can visit our website at www.humminbird.com or contact our Customer Resource Center at 1-800-633-1468 for additional details.



Matrix 47 3D Title Screen

Powering Up the Unit

Turn on your Matrix™ Fishing System by pressing the POWER/LIGHT key. The Title screen is displayed until the Fishing System begins operation. Your Fishing System will begin Normal or Simulator operation, depending on the presence or absence of a transducer.

The Menu System

The menu system is divided into easy-to-use menu modules. The main components of the menu system are:

Start-Up Options Menu - Press the MENU key during the power up sequence to view the Start-Up Options menu.

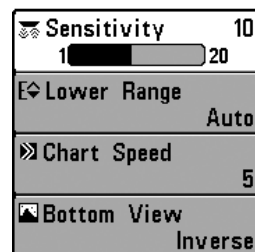

X-Press™ Menu

X-Press™ Menu - The X-Press™ Menu allows you to access the settings that are changed frequently without having to navigate through the whole menu system. Press the MENU key once to display the X-Press™ Menu. When you select a menu item from the X-Press™ Menu, the menu will collapse, leaving only the menu choice on the screen. Use the UP or DOWN Cursor keys to reactivate the X-Press™ Menu.

NOTE: The X-Press™ Menu choices will vary depending on which view is active when you press the MENU key, as well as whether you are in Normal or Advanced User Mode.

Main Menu Tabs - Less frequently-adjusted menus are grouped into the Main Menu System. The Main Menu system is organized under the following tab headings to help you find a specific menu item quickly: Alarms, Sonar, Setup, Views, and Accessories.

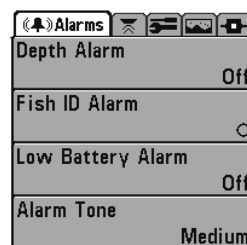

Main Menu System
Normal User Mode

Press the MENU key twice for the Main Menu, then use the 4-WAY Cursor LEFT or RIGHT key to select a tab, and use the DOWN or UP key to select a specific menu item under that tab, then use the LEFT or RIGHT keys again to change a menu setting. Press the EXIT key to move quickly to the top of the tab. A down arrow at the bottom of a menu means that you can scroll to additional menu choices using the DOWN Cursor key. A right or left arrow on a menu choice means that you can use the RIGHT or LEFT Cursor keys to make changes or see more information.

NOTE: The Main Menu choices will vary depending on whether you are in Normal or Advanced User Mode.

User Mode (Normal or Advanced) - An Advanced Mode is provided for users who desire the highest level of control over the Fishing System and Normal Mode for users who desire greater simplicity and fewer menu choices. While you are in Advanced Mode, additional Advanced menu choices will be displayed throughout the menu system when you navigate to specific menus. Any changes made while in Advanced Mode will remain in effect after you switch back to Normal Mode. See *Setup Menu Tab: User Mode* for specific instructions on changing to Advanced User Mode.

Sonar Tab, Normal Mode		Sonar Tab, Advanced Mode	
3D Bottom Style	Shaded with Grid	3D Bottom Style	Shaded with Grid
3D Frame Style	3	3D Frame Style	3
6-Beam Sonar Style	Slanted	Beam Select	83kHz
Beam Select	83kHz	Fish ID+	Symbol+Depth
Fish ID+	Symbol+Depth	Fish Sensitivity	5
Fish Sensitivity	5	Fish ID 3D Reference	Bottom
Fish ID 3D Reference	Bottom	RTS Window	Wide
RTS Window	Wide	Depth Lines	On
		Surface Clutter	5
		Noise Filter	Low
		Max Depth	Auto
		Water Type	Fresh

Sonar Tab, Normal Mode

Sonar Tab, Advanced Mode

Start-Up Options Menu

Press the MENU key when the Title screen is displayed to access the Start-Up Options menu.

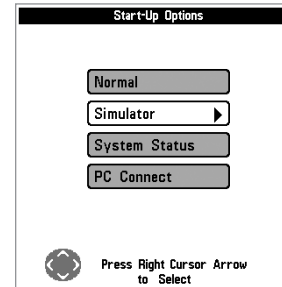

Start-Up Options Menu

Use the UP or DOWN 4-WAY Cursor Control keys to position the cursor, then the RIGHT Cursor key to select one of the following choices. If you wait too long, the system will default to whichever menu mode happens to be highlighted:

- Normal
- Simulator
- System Status
- PC Connect (use with PC Connect Cable).

See the following paragraphs for more information about each of these choices.

Normal Operation

Use Normal operation for on-the-water operation with a transducer connected. In addition, your Matrix™ Fishing System uses advanced transducer detection methods to determine if a transducer is connected. If a functioning transducer is connected, Normal operation will be selected automatically at power up and your Matrix™ Fishing System can be used on the water.

Exit Normal operation by powering your Matrix™ Fishing System off.

Simulator

Use the Simulator to learn how to use your Matrix™ Fishing System before taking your boat on the water. The Simulator is a very powerful tool that simulates on the water operation, providing a randomly-updated display. We recommend going through this manual while using the Simulator, since all of the menus function and affect the display the way they actually do when in Normal operation.

NOTE: To get the full benefit of the Simulator, it is important to select Simulator manually from the Start-Up Options menu as opposed to letting your Matrix™ Fishing System enter Simulator automatically (as it will if a transducer is not connected and you do nothing during power up). Manually selecting Simulator from the Start-Up Options menu allows you to pre-configure your Matrix™ Fishing System for on the water operation. Any menu changes you make will be saved for later use.

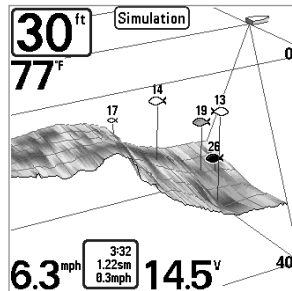

Simulator

A message will appear on the display periodically to remind you that you are using the Simulator.

Exit the Simulator by powering your Matrix™ Fishing System off.

SYSTEM STATUS	
SELF TEST	
PASSED	
S/N	
0-1-1000000000	
SOFTWARE VERSION	
2.005	
VOLTAGE	TOTAL TIME
13.8V	84hrs
PCB S/N	
0-0-0000000	
Press VIEW for Next Screen	

System Status Self Test Screen

System Status

Use System Status to view system connections and to conduct a unit self-test.

The following screens are displayed in turn when you press the VIEW button when using System Status:

- Self Test
- Accessory Test.

Self Test displays results from the internal diagnostic self test, including unit serial number, Printed Circuit Board (PCB) serial number, software revision, total hours of operation and the input voltage.

SYSTEM STATUS	
ACCESSORY TEST	
GPS	UNCONNECTED
SmartCast WSL	UNCONNECTED
Speed	CONNECTED
Temperature	CONNECTED
WeatherSense	UNCONNECTED
Exit SYSTEM STATUS by powering the unit off	

System Status Accessory Test Screen

Accessory Test lists the accessories connected to the system.

NOTE: The speed accessory will be detected only if the paddlewheel has moved since your Matrix™ Fishing System was powered up.

Exit System Status by powering your Matrix™ Fishing System off.

PC Connect

(With PC Connect Cable Only)

Use PC Connect to update the software of the Matrix™ control head. This feature requires the use of the PC Connect Cable. Complete instructions are included with the PC Connect Cable accessory.

NOTE: The PC Connect Cable requires a separate purchase. For more information visit our website at www.humminbird.com or contact our Customer Resource Center at 1-800-633-1468.

Exit PC Connect mode by powering your Matrix™ Fishing System off.

3D Bottom Zoom	Off
3D Lower Range	Auto
3D History	6
2D Sonar Window	Medium
Reset View	
6-Beam Sensitivity	10
Sensitivity	10
Upper Range	0ft
Lower Range	Auto
Chart Speed	8
Bottom View	Structure ID
Zoom Level	2x

Sonar X-Press™ Menu

Sonar X-Press™ Menu

The **Sonar X-Press™ Menu** provides access to the settings most frequently-used. Press the MENU key once while in any of the Sonar Views to access the Sonar X-Press™ Menu.



3D Bottom Zoom (3D Sonar, 3D/2D Sonar Combo Views Only)

3D Bottom Zoom provides a magnified image of the bottom, and is only available on the X-Press™ Menu in the 3D Sonar View and the 3D/2D Sonar Combo View. Use 3D Bottom Zoom to increase the detail of the bottom on the display.

To adjust the 3D Bottom Zoom:

1. Highlight 3D Bottom Zoom on the Sonar X-Press™ Menu.
2. Use the LEFT or RIGHT 4-WAY Cursor Control keys to change the 3D Bottom Zoom setting. (Off, 1.5x, 2x, 2.5x, 3x, Default = Off)



3D Lower Range (3D Sonar, 3D/2D Sonar Combo, 6-Beam Sonar Views Only)

3D Lower Range sets the deepest depth range that will be displayed, and is only available on the X-Press™ Menu when you are in the 3D Sonar, 3D/2D Sonar Combo, or the 6-Beam Sonar View. Automatic is the default setting. When in automatic mode, the lower range will be adjusted by the unit to follow the bottom. Selecting a specific setting locks the depth range into Manual mode.

For example, if you are fishing in 60 feet of water but are only interested in the first 30 feet (surface to a depth of 30 feet) you should set the Lower Depth Range limit to 30. The display will show the 0 to 30 foot range, allowing you to see a more detailed view than you would see if the display went all the way to the bottom.

To adjust the 3D Lower Range:

1. Highlight 3D Lower Range on the Sonar X-Press™ Menu.
2. Use the LEFT or RIGHT 4-WAY Cursor Control keys to increase or decrease the Lower Range setting. (AUTO, 10 to 240 feet, 3 to 75 meters [*International Models Only*], Default = AUTO)



3D History

(3D Sonar, 3D/2D Sonar Combo Views Only)

3D History determines the speed at which the sonar information moves across the display, and consequently the amount of history shown, and is only available on the X-Press™ Menu when you are in the 3D Sonar or the 3D/2D Sonar Combo Views. A faster speed shows less history and is preferred by most anglers; however, the sonar information moves across the display quickly. A slower speed keeps the information on the display longer, but the bottom becomes compressed and may be difficult to interpret. Adjust 3D History to your personal preference.

To adjust the 3D History:

1. Highlight 3D History on the Sonar X-Press™ Menu.
2. Use the LEFT or RIGHT 4-Way Cursor Control keys to increase or decrease the 3D History setting. (Most, 2 - 9, Least; Default = 6)



2D Sonar Window

(3D/2D Sonar Combo View Only)

2D Sonar Window sets the width of the 2-dimensional Sonar Window, and is only available on the X-Press™ Menu when you are in the 3D/2D Sonar Combo View.

To adjust the 2D Sonar Window:

1. Highlight 2D Sonar Window on the Sonar X-Press™ Menu.
2. Use the LEFT or RIGHT 4-WAY Cursor Control keys to change the width of the 2D Sonar Window. (Wide, Medium, Narrow, Default = Medium)

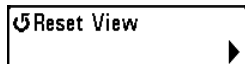

Reset View

(3D Sonar, 3D/2D Sonar Combo Views Only)

Reset View resets the orientation, 3D Bottom Zoom, and 3D Lower Range, and is only available on the X-Press™ Menu when you are in the 3D Sonar or the 3D/2D Sonar Combo Views.

To Reset View:

1. Highlight Reset View on the Sonar X-Press™ Menu.
2. Use the RIGHT 4-WAY Cursor Control key to reset the view.



6-Beam Sensitivity

(6-Beam Sonar View Only)

6-Beam Sensitivity controls how much detail is shown on the display, and is only available on the X-Press™ Menu when you are in the 6-Beam Sonar View only. Increasing the sensitivity shows more sonar returns from small baitfish and suspended debris in the water; however, the display may become too cluttered. When operating in very clear water or greater depths, increased sensitivity shows weaker returns that may be of interest. Decreasing the sensitivity eliminates the clutter from the display that is sometimes present in murky or muddy water. If Sensitivity is adjusted too low, the display may not show many sonar returns that could be fish.

To adjust the 6-Beam Sensitivity:

1. Highlight 6-Beam Sensitivity on the Sonar X-Press™ Menu.
2. Use the LEFT or RIGHT 4-WAY Cursor Control keys to increase or decrease the 6-Beam Sensitivity setting. (Low = 1, High = 20, Default = 10)



Sensitivity

(2D Sonar, 2D Zoom, 2D Big Digits Views Only)

Sensitivity controls how much detail is shown on the display, and is only available on the X-Press™ Menu when you are in the 2D Sonar, 2D Zoom, 2D Big Digits Views only. Increasing the sensitivity shows more sonar returns from small baitfish and suspended debris in the water; however, the display may become too cluttered. When operating in very clear water or greater depths, increased sensitivity shows weaker returns that may be of interest. Decreasing the sensitivity eliminates the clutter from the display that is sometimes present in murky or muddy water. If Sensitivity is adjusted too low, the display may not show many sonar returns that could be fish.

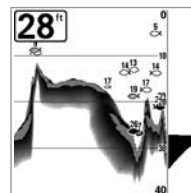

Sensitivity at Low

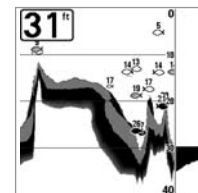

Sensitivity at Medium

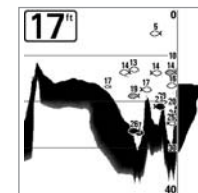

Sensitivity at High

To adjust the Sensitivity:

1. Highlight Sensitivity on the Sonar X-Press™ Menu.
2. Use the LEFT or RIGHT 4-WAY Cursor Control keys to increase or decrease the Sensitivity setting. (Low = 1, High = 20, Default = 10)

Upper Range 35ft
0 990

Upper Range

(Advanced: 2D Sonar, 2D Big Digits Views Only)

Upper Range sets the shallowest depth range that will be displayed. The Upper Range menu choice is available when User Mode is set to Advanced (see *Setup Menu Tab: User Mode*) and is only available on the X-Press™ Menu when you are in the 2D Sonar or 2D Big Digits Views. Upper Range is often used with Lower Range.

For example, if you are only interested in the area between 20 and 50 feet deep, you should set the Upper Depth Range to 20 and the Lower Depth Range to 50. The 2D Sonar View will then show the 30 foot area between 20 and 50, and will not show the surface or the bottom (assuming the bottom is deeper than 50 feet), and will show greater detail for that area between 20 and 50 feet.

NOTE: A minimum distance of 10 feet will be maintained between the Upper and Lower Range regardless of the manual settings entered.

To adjust the Upper Range:

1. Make sure you are in Advanced Mode, then highlight Upper Range on the Sonar X-Press™ Menu.
2. Use the LEFT or RIGHT 4-WAY Cursor Control keys to increase or decrease the Upper Range setting. (0 to 990 feet or 0 to 327 meters [*International Models Only*], Default = 0)

Lower Range 63ft
Auto 1000

Lower Range

(2D Sonar, 2D Zoom, 2D Big Digits Views Only)

Lower Range sets the deepest depth range that will be displayed, and is only available on the X-Press™ Menu when you are in the 2D Sonar, 2D Zoom, or 2D Big Digits Views. Automatic is the default setting. When in automatic mode, the lower range will be adjusted by the unit to follow the bottom. Selecting a specific setting locks the depth range into Manual mode. Use both Upper and Lower Range together to view a specific depth range manually when looking for fish or bottom structure. **M** will be displayed in the lower right corner of the screen when you start manually adjusting the Lower Range to indicate that you are in Manual mode.

For example, if you are fishing in 60 feet of water but are only interested in the first 30 feet (surface to a depth of 30 feet) you should set the Lower Depth Range limit to 30. The display will show the 0 to 30 foot range, allowing you to see a more detailed view than you would see if the display went all the way to the bottom.

NOTE: A minimum distance of 10 feet will be maintained between the Upper and Lower Range regardless of the manual settings entered.

To adjust the Lower Range:

1. Highlight Lower Range on the Sonar X-Press™ Menu.
2. Use the LEFT or RIGHT 4-WAY Cursor Control keys to increase or decrease the Lower Range setting. (AUTO, 10 to 1000 feet, 3 to 330 meters [*International Models Only*], Default = AUTO)



Chart Speed

(2D Sonar, 2D Zoom, 2D Big Digits Views Only)

Chart Speed determines the speed at which the sonar information moves across the display, and consequently the amount of detail shown, and is only available on the X-Press™ Menu when you are in the 2D Sonar, 2D Zoom, or 2D Big Digits Views. A faster speed shows more information and is preferred by most anglers; however, the sonar information moves across the display quickly. A slower speed keeps the information on the display longer, but the bottom and fish details become compressed and may be difficult to interpret. Regardless of the Chart Speed setting, the RTS® Window will update at the maximum rate possible for the depth conditions. Adjust Chart Speed to your personal preference.

To adjust the Chart Speed:

1. Highlight Chart Speed on the Sonar X-Press™ Menu.
2. Use the LEFT or RIGHT 4-Way Cursor Control keys to increase or decrease the Chart Speed setting. (1 - 9, Ultra, where 1 = Slow, Ultra = Fastest, Default = 8)



Bottom View

(2D Sonar, 2D Zoom, 2D Big Digits Views Only)

Bottom View selects the method used to represent bottom and structure on the display, and is only available on the X-Press™ Menu when you are in the 2D Sonar, 2D Zoom, or 2D Big Digits Views. **Inverse** represents weak returns as dark pixels and strong returns as lighter pixels. This has the benefit of ensuring that weak signals will be clearly visible on the display. **Structure ID®** represents weak returns as light pixels and strong returns as dark pixels. This has the benefit of ensuring that strong returns will be clearly visible on the display. **WhiteLine®** highlights the strongest sonar returns in white resulting in a distinctive outline. This has the benefit of clearly defining the bottom on the display. **Bottom Black** displays all pixels below the bottom contour as black, regardless of signal strength. This has the benefit of providing a high contrast between the bottom and other sonar returns on the display. Any targets such as fish, structure and thermoclines will be shown using the Structure ID® method. See **Bottom Presentation** for more information.

To adjust the Bottom View:

1. Highlight Bottom View on the Sonar X-Press™ Menu.
2. Use the LEFT or RIGHT 4-WAY Cursor Control keys to change the Bottom View setting. (Inverse, Structure ID, WhiteLine, Bottom Black, Default = Inverse)

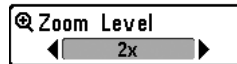

Zoom Level

(2D Zoom View Only)

Zoom Level sets the magnification level for the 2D Zoom View, and is only available on the X-Press™ Menu when you are in the 2D Zoom View. Use Zoom to increase the display resolution to separate sonar returns that are very close together.

To adjust the Zoom Level:

1. Highlight Zoom Level on the Sonar X-Press™ Menu.
2. Use the LEFT or RIGHT 4-WAY Cursor Control keys to change the Zoom Level setting for the 2D Zoom View. (2x, 4x, 6x, 8x, Default = 2x)

NOTE: The Zoom Preview Box tracks the bottom and cannot be moved by the user.

Sonar	
3D Bottom Style	Shaded with Grid
3D Frame Style	3
Beam Select	83kHz
Fish ID+	Symbol+Depth
Fish Sensitivity	5
Fish ID 3D Reference	Bottom
RTS Window	Wide
Depth Lines	On
Surface Clutter	5
Noise Filter	Low
Max Depth	Auto
Water Type	Fresh

Sonar Menu

Sonar Menu Tab

Press the MENU key twice to access the Main Menu System and then press the RIGHT 4-WAY Cursor Control key to select the Sonar tab.

3D Bottom Style
◀ Shaded with Grid ▶

3D Bottom Style

3D Bottom Style selects the bottom style used in the 3D Sonar View.

To change the 3D Bottom Style setting:

1. Highlight 3D Bottom Style on the Sonar main menu.
2. Use the LEFT or RIGHT 4-WAY Cursor Control keys to change the 3D Bottom Style setting. (Grid Only, Shaded with Grid, Shaded, Default = Shaded with Grid)

3D Frame Style 3
Simple ████ Complex

3D Frame Style

3D Frame Style selects the frame style used in the 3D Sonar View.

To change the 3D Frame Style setting:

1. Highlight 3D Frame Style on the Sonar main menu.
2. Use the LEFT or RIGHT 4-WAY Cursor Control keys to change the 3D Frame Style setting. (Simple, 2, 3, 4, Complex, Default = 3)

Beam Select
◀ 455kHz ▶

Beam Select

Beam Select sets which sonar returns from the transducer will be displayed on the screen.

When Beam Select is set to 455 kHz, the returns from the 455 kHz narrow beams will be displayed in all views, and the maximum depth capability of your unit will be 240 ft (75 m).

When the depth is greater than 240 ft (75 m), Beam Select should be set to 83 kHz. The unit will continue to acquire sonar returns below 240 ft and will be displayed in the 2D Sonar View.

NOTE: It is important to re-set Beam Select to 455 kHz when returning to water shallower than 240 ft (75 m) for maximum performance in the 3D views.

To change Beam Select:

1. Highlight Beam Select on the Sonar main menu.
2. Use the LEFT or RIGHT 4-WAY Cursor Control keys to select either the 455 kHz beam or the 83kHz beam. (455 kHz, 83 kHz, Default = 455 kHz)

Fish ID + **Fish ID+™**

◀ Symbol+Depth ▶

Fish ID+™ uses advanced signal processing to interpret sonar returns, and will display a Fish Symbol when very selective requirements are met. When a fish is detected, a fish icon and its depth are displayed above the return that has been classified as being a fish. Fish symbols come in three different sizes to indicate the intensity of the return; in addition, there is a unique symbol set associated with each of the six beams, for a total of 18 possible fish symbols which can be displayed. The following graphic illustrates the different Fish ID+™ symbols and shows the beams with which they are associated. For instance, a hollow fish facing left indicates it was detected in the far left beam and a hollow fish facing right indicates it was detected in the far right beam.

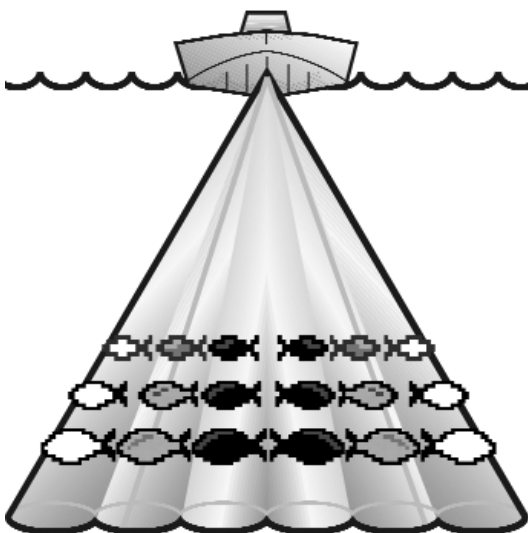

When Fish ID+™ is turned off, the Fishing System shows only the raw sonar returns on the display.

To set Fish ID+™:

1. Highlight Fish ID+ on the Sonar main menu.
2. Use the LEFT or RIGHT 4-WAY Cursor Control keys to change the Fish ID+ setting. (Off, Symbol Only, Symbol+Depth, Default = Symbol+Depth)

Fish Sensitivity **Fish Sensitivity**

Fish Sensitivity 5
1 10

Fish Sensitivity adjusts the threshold of the Fish ID+™ detection algorithms. Selecting a higher setting allows weaker returns to be displayed as fish. This is useful for identifying smaller fish species or baitfish. Selecting a lower setting displays fewer fish from weak sonar returns. This is helpful when seeking larger species of fish. Fish Sensitivity is used in conjunction with Fish ID+™. Fish ID+™ must be set to either Symbol Only or Symbol+Depth for Fish Sensitivity to affect the ability of your Matrix™ Fishing System to identify sonar returns as fish.

To change the Fish Sensitivity setting:

1. Highlight Fish Sensitivity on the Sonar main menu.
2. Use the LEFT or RIGHT 4-WAY Cursor Control keys to change the Fish Sensitivity setting. (Low = 1, High = 10, Default = 5)

Fish ID 3D Reference **Fish ID 3D Reference**

Fish ID 3D Reference
◀ Bottom ▶

Fish ID 3D Reference selects the reference line style used in the 3D Sonar View. Up draws a line from the fish icon to the surface plane, Down draws a line from the fish icon to the bottom contour, and Both draws both lines.

To change the Fish ID 3D Reference setting:

1. Highlight 3D Fish ID Reference Line on the Sonar main menu.
2. Use the LEFT or RIGHT 4-WAY Cursor Control keys to change the Fish ID 3D Reference setting. (Surface, Both, Bottom, Default = Bottom)

RTS Window

◀ Narrow ▶

Real Time Sonar (RTS®) Window

RTS® Window sets the RTS® Window to either Wide or Narrow, or turns it off in the 3D or 2D Sonar Views. The RTS® Window always updates at the fastest rate possible and only displays returns that are within the transducer beam. (See *Real Time Sonar (RTS®) Window* for additional detail).

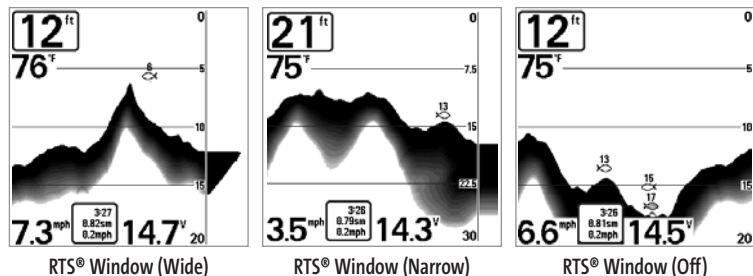

RTS® Window (Wide)

RTS® Window (Narrow)

RTS® Window (Off)

To change the RTS® Window setting:

1. Highlight RTS Window on the Sonar main menu.
2. Use the LEFT or RIGHT 4-WAY Cursor Control keys to change the RTS® Window setting. (Wide, Narrow, Off, Default = Wide)

Depth Lines

◀ On ▶

**Depth Lines
(Advanced)**

Depth Lines divide the display into four equal sections which are separated by three horizontal depth lines. The depth of each line is displayed along the depth scale. You can either turn Depth Lines On or Off. The Depth Lines menu choice is available when User Mode is set to Advanced (see *Setup Menu Tab: User Mode*).

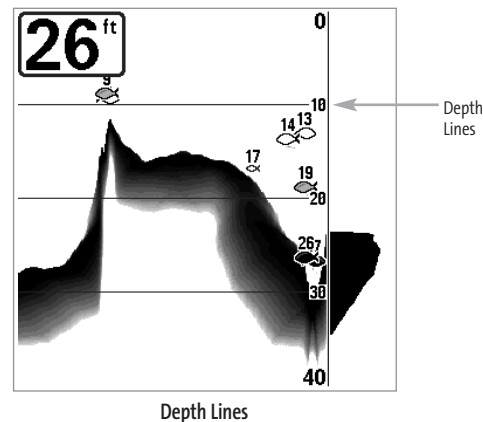

Depth Lines

To change the Depth Lines setting:

1. Make sure you are in Advanced User Mode, then highlight Depth Lines on the Sonar main menu.
2. Use the LEFT or RIGHT 4-WAY Cursor Control keys to turn the Depth Lines setting On or Off. (Off, On, Default = On)

Surface Clutter 5
1  10
Surface Clutter
(Advanced)

Surface Clutter adjusts the filter that removes surface clutter noise caused by algae and aeration. The lower the setting, the less surface clutter will be displayed. The Surface Clutter menu choice is available when User Mode is set to Advanced (see *Setup Menu Tab: User Mode*).

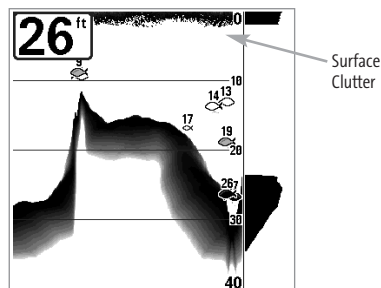

To change the Surface Clutter setting:

1. Make sure you are in Advanced User Mode, then highlight Surface Clutter on the Sonar main menu.
2. Use the LEFT or RIGHT 4-WAY Cursor Control keys to change the Surface Clutter setting. (Low = 1 to High = 10, Default = 5)

Noise Filter
◀ **Medium** ▶
Noise Filter
(Advanced)

Noise Filter adjusts the sonar noise filter to limit interference on the display from sources such as your boat engine, turbulence, or other sonar devices. The Noise Filter menu choice is available when User Mode is set to Advanced (see *Setup Menu Tab: User Mode*).

NOTE: The Off setting removes all filtering; Low, Medium and High settings add progressive filtering of the sonar returns. In some deep water situations, the High setting may actually hinder your unit's ability to find the bottom.

To change the Noise Filter setting:

1. Make sure you are in Advanced User Mode, then highlight Noise Filter on the Sonar main menu.
2. Use the LEFT or RIGHT 4-WAY Cursor Control keys to change the Noise Filter setting. (Off, Low, Medium, High, Default = Low)

Max Depth 113ft
Auto  1000
Max Depth
(Advanced)

Max Depth adjusts the maximum depth of operation. The performance of your Matrix™ Fishing System can be tuned to the maximum depth you will be fishing in by setting the Max Depth. When a maximum depth is set, your unit will not attempt to acquire sonar data below that depth, thus increasing overall performance. When Max Depth is set to Auto, your unit will acquire bottom readings as needed (within the depth capacity of the unit). If the bottom is deeper than the Max Depth setting, the digital depth readout will flash, indicating that your unit cannot locate the bottom. The Max Depth menu choice is available when User Mode is set to Advanced (see *Setup Menu Tab: User Mode*).

To change the Max Depth setting:

1. Make sure you are in Advanced User Mode, then highlight Max Depth on the Sonar main menu.
2. Use the LEFT or RIGHT 4-WAY Cursor Control keys to change the Max Depth setting. (AUTO, 10 to 1000 feet, 3 to 330 meters [*International Models Only*], Default = AUTO)

Water Type
◀ **Fresh** ▶
Water Type
(Advanced)

Water Type configures your unit for operation in fresh or salt water. The Water Type menu choice is available when User Mode is set to Advanced (see *Setup Menu Tab: User Mode*).

NOTE: In salt water, what would be considered a large fish might be 2 to 10 times bigger than a large fish in fresh water (depending on the type of fish you are seeking). The salt water setting allows for a greater range in fish size adjustment to account for this. Also, make sure that the Water Type is set accurately, especially in salt water, as this affects the accuracy of deep water depth readings.

To change the Water Type setting:

1. Make sure you are in Advanced User Mode, then highlight Water Type on the Sonar main menu.
2. Use the LEFT or RIGHT 4-WAY Cursor Control keys to change the Water Type setting. (Fresh, Salt, Default = Fresh)

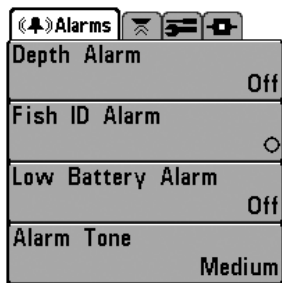

Alarms Menu

Alarms Menu Tab

From any view, press the MENU key twice to access the Main Menu System. The Alarms tab will be the default selection.

NOTE: When an alarm is triggered, you can silence it by pressing any key. The alarm will be silenced, and will not be triggered again until a new instance of the alarm condition is detected.

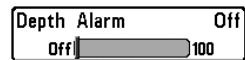

Depth Alarm

Depth Alarm sounds when the depth becomes equal to or less than the menu setting.

To change the Depth Alarm setting:

1. Highlight Depth Alarm on the Alarms main menu.
2. Use the LEFT or RIGHT 4-WAY Cursor Control keys to change the Depth Alarm setting. (OFF, 1 to 100 feet, or 0.5 to 30 meters *[International Models Only]*, Default = OFF)



Fish ID Alarm

Fish ID Alarm sounds when your Matrix™ Fishing System detects fish that correspond to the alarm setting. Fish ID Alarm will only sound if Fish ID+™ is on.

For example, if you've set the Fish ID Alarm to sound for Large fish only, the Fish ID Alarm will sound when a large-sized fish is detected.

To change the Fish ID Alarm setting:

1. Highlight Fish ID Alarm on the Alarms main menu.
2. Use the LEFT or RIGHT 4-WAY Cursor Control keys to change the Fish ID Alarm setting. (Off, All, Large/Medium, Large, Default = Off)



Low Battery Alarm 9.5V
Off  13.5

Low Battery Alarm

Low Battery Alarm sounds when the input battery voltage is equal to or less than the menu setting. The battery alarm will only sound for the battery that is connected to the Matrix™ Fishing System. The Low Battery Alarm should be set to warn you when the battery voltage drops below the safety margin that you have determined. For instance, if you are running a trolling motor (battery operated), you would want to set the Low Battery Alarm to sound before the battery voltage drops too low for it to be used to start your main, gasoline-powered engine.

To change the Low Battery Alarm setting:

1. Highlight Low Battery Alarm on the Alarms main menu.
2. Use the LEFT or RIGHT 4-WAY Cursor Control keys to change the Low Battery Alarm setting. (Off, 8.5V - 13.5V, Default = Off)

Alarm Tone
◀ Medium ▶

Alarm Tone

Alarm Tone selects the pitch of the alarm sound. A brief tone will be produced as you adjust the Alarm Tone so that you can select the tone that you can hear best.

To change the Alarm Tone setting:

1. Highlight Alarm Tone on the Alarms main menu.
2. Use the LEFT or RIGHT 4-WAY Cursor Control keys to change the Alarm Tone setting. (High, Medium, Low, Default = Medium)

Setup	
Units - Depth	Feet
Units - Temp	°F
Units - Distance	Feet/Statute Miles
Units - Speed	mph
User Mode	Advanced
Language	English
Triplog Reset	
Restore Defaults	
Select Readouts	
Depth Offset	0.0ft
Temp. Offset	0.0°
Speed Calibration	0%
NMEA Output	Off

Setup Menu

Setup Menu Tab

From any view, press the MENU key twice to access the tabbed Main Menu System, then press the RIGHT 4-WAY Cursor Control key until the Setup tab is selected.

Units - Depth

◀ Feet ▶

Units - Depth

Units - Depth selects the unit of measure for all depth-related readouts.

To change the Units - Depth setting:

1. Highlight Units - Depth on the Setup main menu.
2. Use the LEFT or RIGHT 4-WAY Cursor Control keys to change the Units - Depth setting. (Meters [*International Models Only*], Feet, Fathoms; Default is Meters for International models, and Feet for Domestic models)

Units - Temp

◀ °f ▶

Units - Temp**(International Only)**

Units - Temp selects the unit of measure for all temperature-related readouts. *International Models Only.*

To change the Units - Temp setting:

1. Highlight Units - Temp on the Setup main menu.
2. Use the LEFT or RIGHT 4-WAY Cursor Control keys to change the Units - Temp setting. (Celsius, Fahrenheit; Default = Celsius)

Units - Distance

◀ Feet/Statute Miles ▶

Units - Distance**(with Temp/Speed or GPS Receiver)**

Units - Distance selects the units of measure for all distance-related readouts, and will appear in the menu if a Temp/Speed Accessory is connected and the paddlewheel has moved at least once, or if a GPS Receiver is connected.

To change the Units - Distance setting:

1. Highlight Units - Distance on the Setup main menu.
2. Use the LEFT or RIGHT 4-WAY Cursor Control keys to change the Units - Distance setting. (Domestic Models: Statute Miles, Nautical Miles; Default = Statute Miles; International Models: Meters/Kilometers, Meters/Nautical Miles, Feet/Statute Miles, Feet/Nautical Miles; Default = Meters/Kilometers)

Units - Speed

◀ mph ▶

Units - Speed**(with Temp/Speed or GPS Receiver)**

Units - Speed selects the unit of measure for speed-related readouts, and will appear in the menu if a Temp/Speed Accessory is connected and the paddlewheel has moved at least once, or if a GPS Receiver is connected.

To change the Units - Speed setting:

1. Highlight Units - Speed on the Setup main menu.
2. Use the LEFT or RIGHT 4-WAY Cursor Control keys to change the Units - Speed setting. (kph [*International Models Only*], mph, kts, Default = kph for International models and mph for Domestic models)

User Mode

◀ Advanced ▶

User Mode

User Mode sets the menu system to either Normal or Advanced. When set to Normal (default setting,) only the basic menu options are shown. When set to Advanced, additional menu choices are available throughout the menu system.

To change the User Mode setting:

1. Highlight User Mode on the Setup main menu.
2. Use the LEFT or RIGHT 4-WAY Cursor Control keys to change the User Mode setting. (Normal, Advanced, Default = Normal)

Language

◀ English ▶

Language**(International Only)**

Language selects the display language for menus. *International Models Only.*

To change the Language setting:

1. Highlight Language on the Setup main menu.
2. Use the LEFT or RIGHT 4-WAY Cursor Control keys to change the Language setting. (Default = English)

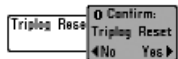

Triplog Reset

(with Temp/Speed or GPS Receiver)

Triplog Reset resets the Triplog to zero, and will appear in the menu if a Temp/Speed Accessory is connected and the paddlewheel has moved at least once, or if a GPS Receiver is connected. The Triplog provides the following information: timer for elapsed time, distance traveled since last reset, and average speed.

NOTE: See *Setup Menu Tab: Select Readouts* to find out how to display Triplog information on the screen.

To Reset Triplog:

1. Highlight Reset Triplog on the Setup main menu.
2. Use the RIGHT 4-WAY Cursor Control key to initiate Triplog Reset.
3. The Confirm dialog box will appear. To reset the Triplog, press the RIGHT 4-WAY Cursor Control key once more. To cancel Reset Triplog, press the LEFT 4-WAY Cursor Control key.

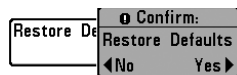

Restore Defaults

Restore Defaults resets ALL menu settings to their factory defaults. Use this menu choice with caution!

To Restore Defaults:

1. Highlight Restore Defaults on the Setup main menu.
2. Use the RIGHT 4-WAY Cursor Control key to initiate restoring defaults.
3. The Confirm dialog box will appear. To reset the defaults, press the RIGHT 4-WAY Cursor Control key once more. To cancel Restore Defaults, press the LEFT 4-WAY Cursor Control key.

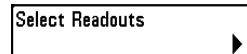

Select Readouts

(Advanced: 3D and 2D Sonar Views Only)

Select Readouts sets individual digital readouts on the 3D or 2D Sonar View. This Advanced feature allows you to select what data will be displayed in each of 6 fixed-position data windows arranged around the left and bottom edges of the 3D or 2D Sonar View screen, or whether a particular data window will be turned off, displaying nothing in that area; you can access this menu choice only when in Advanced User Mode (see *Setup Menu Tab: User Mode*.)

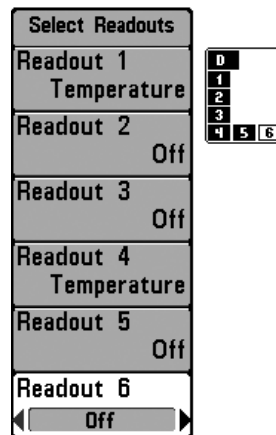

Select Readouts

Data windows can display readouts from supported accessories such as Temp/Speed. Each data window can either be empty or contain one of the following:

- **Speed** (will be displayed if a Temp/Speed Accessory is attached and the paddlewheel has moved at least once, or if a GPS Receiver is connected)
- **Temperature**
- **Triplog** (will be displayed if a Temp/Speed Accessory is attached and the paddlewheel has moved at least once, or if a GPS Receiver is connected)
- **Voltage**
- **Water Speed** (will only be displayed if a Temp/Speed Accessory is attached and the paddlewheel has moved at least once). Water Speed is not available with a GPS receiver.

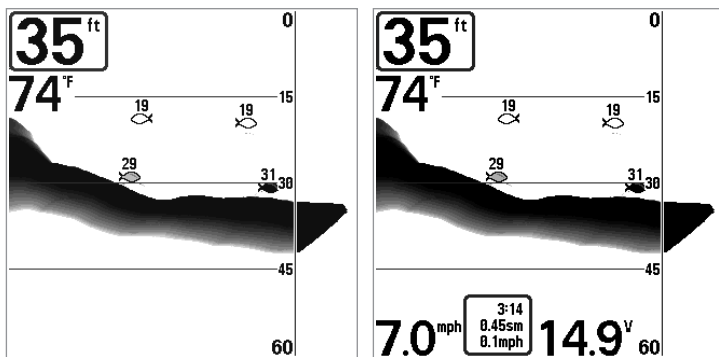

Default 2D Sonar View

Customized 2D Sonar View

To Select Readouts:

1. Make sure you are in Advanced User Mode, highlight Select Readouts on the Setup main menu.
2. Use the RIGHT 4-WAY Cursor Control key to initiate this procedure.
3. The Select Readouts submenu will appear, showing a list of all Readouts. Use the UP or DOWN Cursor Control keys to select a particular Readout position, then use the RIGHT or LEFT Cursor Control keys to change what will be displayed at that position. (Off, Speed, Temperature, Triplog, Voltage, Water Speed)

Depth Offset 0.0ft -10.0 10.0 Depth Offset (Advanced)

Depth Offset will adjust the digital depth readout to indicate depth from the waterline or boat's keel. Enter a positive vertical measurement from the transducer to the waterline to read the depth from the waterline. Enter a negative vertical measurement from the transducer to keel to read the depth from the keel. This menu choice is available only when in Advanced User Mode (see *Setup Menu Tab: User Mode*.)

To change the Depth Offset setting:

1. Make sure you are in Advanced User Mode, then highlight Depth Offset on the Setup main menu.
2. Use the LEFT or RIGHT 4-WAY Cursor Control keys to change the Depth Offset setting. (-10.0 to +10.0 feet or -3 to 3 meters [*International Models Only*], Default = 0)

Temp. Offset 0.0° -10.0 10.0 Temp Offset (Advanced)

Temp Offset will adjust the temperature readout by the amount entered. This menu choice is available only when in Advanced User Mode (see *Setup Menu Tab: User Mode*.)

To change the Temp Offset setting:

1. Make sure you are in Advanced User Mode, then highlight Temp Offset on the Setup main menu.
2. Use the LEFT or RIGHT 4-WAY Cursor Control keys to change the Temp Offset setting. (-10.0 to +10.0 degrees, Default = 0)

Speed Calibration 5% -20 20 Speed Calibration (Advanced: with Temp/Speed Only)

Speed Calibration will adjust the speed readout by the percentage entered, and will appear in the menu if a Temp/Speed Accessory is connected and the paddlewheel has moved at least once, when the unit is in Advanced User Mode (see *Setup Menu Tab: User Mode*.)

To change the Speed Calibration setting:

1. Make sure you are in Advanced User Mode, then highlight Speed Calibration on the Setup main menu.
2. Use the LEFT or RIGHT 4-WAY Cursor Control keys to change the Speed Calibration setting. (-20% to +20%, Default = 0%)



NMEA Output (Advanced)

NMEA Output turns the NMEA output on or off. This menu choice is available only when in Advanced User Mode (see *Setup Menu Tab: User Mode*.)

The following NMEA sentences are output:

DPT Depth
 MTW Water Temperature
 GLL Lat/Lon Position
 GGA GPS Fix Data
 RMC Recommended Minimum Specific GNSS Data
 VTG Course Over Ground and Ground Speed
 ZDA Time and Date

When navigating, the following NMEA sentences are also output:

APB Autopilot Sentence B
 BWR Bearing and Distance to Waypoint
 RMB Recommended Minimum Navigation Info

To turn NMEA Output on or off:

1. Make sure you are in Advanced User Mode, then highlight NMEA Output on the Setup main menu.
2. Use the LEFT or RIGHT 4-WAY Cursor Control keys to change the NMEA Output to On or Off (On, Off, Default = Off).

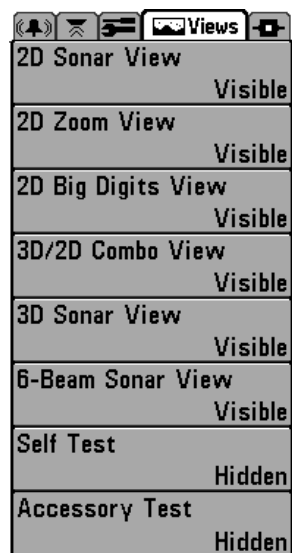

View	Status
2D Sonar View	Visible
2D Zoom View	Visible
2D Big Digits View	Visible
3D/2D Combo View	Visible
3D Sonar View	Visible
6-Beam Sonar View	Visible
Self Test	Hidden
Accessory Test	Hidden

Views Menu

Views Menu Tab

From any view, press the MENU key twice to access the tabbed Main Menu System, then press the RIGHT 4-WAY Cursor Control key until the Views tab is selected. This menu tab allows you to set the available views to either hidden or visible in the view rotation. The view will be removed from the view rotation if it is set to Hidden and will be displayed in the view rotation if it is set to Visible. The following views are available:

- 2D Sonar View
- 2D Zoom View
- 2D Big Digits View
- 3D Sonar View
- 3D/2D Sonar Combo View
- 6-Beam Sonar View
- Self Test
- Accessory Test.

To Change the View Status of Any View:

1. Highlight the View main menu tab.
2. Use the UP or DOWN 4-WAY Cursor Control keys to select a View.
3. Use the LEFT or RIGHT 4-WAY Cursor Control keys to change the status of the view from Hidden to Visible.

Accessories Menu Tab

From any view, press the MENU key twice to access the tabbed Main Menu System, then press the RIGHT 4-WAY Cursor Control key until the Accessories tab is selected. If no accessories are attached to the Accessory Bus, no menu choices will appear under the Accessories tab. If an accessory is attached, however, additional menu choices that support the accessory will be added automatically. See the Operations Manual that comes with your accessory for detailed information.

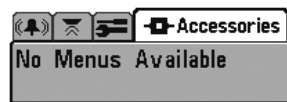

Accessories Menu
(no accessories attached)

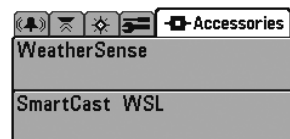

Accessories Menu
(with accessories attached)

NOTE:

Accessories to enable WeatherSense®, GPS Functionality and the SmartCast® Wireless Sonar Link require separate purchases. You can visit our website at www.humminbird.com or contact our Customer Resource Center at 1-800-633-1468 for additional details.

Troubleshooting

Before contacting the Humminbird® Customer Resource Center, please read the following section. Taking the time to review these troubleshooting guidelines may allow you to solve a performance problem yourself, and therefore avoid sending your unit back for repair.

Matrix™ Doesn't Power Up

If your Matrix™ Fishing System doesn't power up, use the Installation Guide that also comes with it for specific confirmation details, making sure that:

- the power cable is properly connected to the Matrix™ control head,
- the power cable is wired correctly, with red to positive battery terminal and black to negative terminal or ground
- the fuse is operational
- the battery voltage of the power connector is at least 10 Volts.

Correct any known problems, including removing corrosion from the battery terminals or wiring, or actually replacing the battery if necessary.

Matrix™ Defaults to Simulator with a Transducer Attached

A connected and functioning transducer will cause the newly-started Matrix™ Fishing System to go into Normal operating mode automatically. If, when you power up your unit, it goes into Simulator mode automatically, even though a transducer is already connected, this means that the control head is not detecting the transducer. Perform the following troubleshooting tasks:

- Using the Installation Guide that also comes with your Matrix™ Fishing System, check to make sure that the transducer cable is securely connected to your unit. Reconnect if necessary, and power up the unit again to see if this fixes the problem.
- Replace the non-functioning transducer with a known good transducer if available and power up the control head again.
- Check the transducer cable. Replace the transducer if the cable is damaged or corroded.

Display Problems

There are several main conditions or sources of possible interference that may cause problems with the quality of the information displayed on the control head. Look in the following table for some symptoms of display problems and possible solutions:

Problem	Possible Cause
The control head loses power at high speeds.	If the power output of your boat's engine is unregulated, the control head may be protecting itself using its over-voltage protection feature. Make sure the input voltage does not exceed 20 Volts.
When the boat moves at higher speeds, the bottom disappears or suddenly weakens, or the display contains gaps.	<p>The transducer position may need to be adjusted. A mix of air and water flowing around the transducer (cavitation) may be interfering with the interpretation of sonar data. See your Installation Guide for suggestions on adjusting the transducer position.</p> <p>Electrical noise from the boat's engine may be interfering with sonar reception. See Finding the Cause of Noise for more information.</p>
There are no fish detected, even when you know they are in the water under the boat, or sonar readings seem weak or faulty.	<p>Sonar readings may be affected if the transducer is not positioned correctly (i.e. mounted at an angle, not straight down), or there is some kind of mechanical interference, either because it is mounted inside a hull that is too thick for proper sonar transmission, the bond between the transducer and the hull is not airtight, or because the transducer is dirty. Check with your Installation Guide for guidance on re-positioning the transducer, and make sure the transducer is clean.</p> <p>Low battery voltage may be affecting the power of signal transmission.</p> <p>Electrical noise from the boat's engine may be interfering with sonar reception. See Finding the Cause of Noise for more information.</p>

Finding the Cause of Noise

Electrical noise usually affects the display with many black dots at high speeds, and high sensitivity readings. One or more of the following sources can cause noise or interference:

Possible Source of Noise	Isolation
Other electronic devices	Turn off any nearby electronic devices to see if the problem goes away, then turn them on one at a time to see if the noise re-appears.
The boat's engine	To determine whether the boat's engine is the source of the noise, increase the RPMs while the boat is in neutral and stationary to see if the noise increases proportionately; if noise appears when you rev the engine, the problem could be the spark plugs, alternator, or tachometer wiring. Replace the spark plugs with resistor plugs, install an alternator filter, or route the control head power and transducer cables away from the engine wiring.
Cavitation from the boat's propeller	Turbulence created by the propeller can cause noise; make sure the transducer is mounted at least 15" (38 cm) from the propeller, and that the water flows smoothly over the face of the transducer at all times.

Matrix™ Fishing System Accessories

Accessories customize the Matrix™ Fishing System to your needs and enable you to stay on the edge of new technology. When an accessory is connected to the Matrix™ Fishing System, additional menus and readouts are added automatically to the Main Menu System. Accessories available today that are supported by your Matrix™ Fishing System include:

Temperature/Speed: purchase and plug in the Temperature/Speed accessory to your Matrix™ control head to get real time speed and temperature readouts, as well as a valuable Triplog function.

NOTE: If an external Temperature/Speed (TS-W) or Temperature (TG-W) accessory is connected AND a transducer with temperature built in is connected at the same time, the TS-W or TG-W accessory will override the temperature which is built in to the transducer.

WeatherSense® Fishing Condition Monitor: purchase and plug in the WeatherSense® accessory to your Matrix™ Fishing System to obtain barometric pressure readouts and trend data in real time.

GR4 GPS Receivers: purchase and connect the GR4 GPS Receiver to your Matrix™ Fishing System to access advanced FishingGPS®, trackplotter and navigation capabilities built-in to your Matrix™ Fishing System.

GPS Connection Cable: purchase the GPS Connection Cable in order to connect a handheld or other NMEA* GPS-compatible device that you may already own to your Matrix™ Fishing System.

Wireless Sonar Link (WSL): purchase the Wireless Sonar Link (WSL) accessory to receive remote sonar signals from a SmartCast® Remote Sonar Sensor (RSS). Radio signals from the RSS are received by the WSL and transmitted over the Accessory Bus to the Matrix™ Fishing System.

PC Connect Cable: Purchase the PC Connect Cable to connect the Matrix™ Fishing System to a PC in order to upload product software updates and new features obtained from **www.humminbird.com**. This accessory requires the MSWindows-compatible HumminbirdPC™ software downloaded from our website to your PC in order to communicate with the Matrix™ Fishing System.

Be sure to check out our website **www.humminbird.com** for additional new and exciting accessories to grow your Matrix™ Fishing System!

*NOTE: Each accessory requires a separate purchase. You can visit our website **www.humminbird.com** or contact our Customer Resource Center at 1-800-633-1468 for additional details.*

*NMEA 0183 is a National Marine Electronics Association standard for data communication.

Specifications

3D Depth Capability	240 ft (75 m)
2D Depth Capability	1000 ft (330 m)
Power Output	1000 Watts (RMS) 8000 Watts (Peak to Peak)
3D Operating Frequency	455 kHz
2D Operating Frequency	455 kHz to 240 ft (75 m) 83 kHz to 1000 ft (330 m)
3D Area of Coverage	53° @ -10 dB in 455 kHz
2D Area of Coverage	60° @ -10 dB in 83 kHz 16° @ -10 dB in 455 kHz
Target Separation	2½ Inches (63.5 mm)
Power Requirement	10-20 VDC
LCD Matrix	640 V x 320 H
Transducer	SHS-7W
Transducer Cable Length	20 ft (6 m)

Product specifications and features are subject to change without notice.

Contact Humminbird®

Contact the Humminbird® Customer Resource Center
in any of the following ways:

By Telephone

(Monday - Friday 8:00 a.m. to 4:30 p.m. Central Standard Time):

1-800-633-1468

By e-mail

(typically we respond to your e-mail within three business days):

custserv@johnsonoutdoors.com

For direct shipping, our address is:

Humminbird®

Service Department

678 Humminbird Lane

Eufaula, AL 36027 USA



Free Manuals Download Website

<http://myh66.com>

<http://usermanuals.us>

<http://www.somanuals.com>

<http://www.4manuals.cc>

<http://www.manual-lib.com>

<http://www.404manual.com>

<http://www.luxmanual.com>

<http://aubethermostatmanual.com>

Golf course search by state

<http://golfingnear.com>

Email search by domain

<http://emailbydomain.com>

Auto manuals search

<http://auto.somanuals.com>

TV manuals search

<http://tv.somanuals.com>