

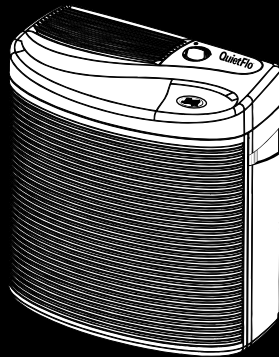

NCE 1886

QuietFlo™

HEPA Air Purifier

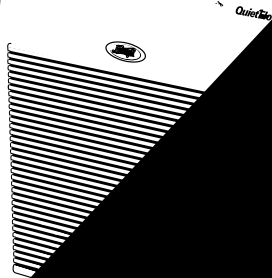

These air purifiers use Model 30940 replacement HEPA filters.
These air purifiers use Model 30903 replacement pre-filters.

IMPORTANT SAFETY INSTRUCTIONS

READ ALL INSTRUCTIONS BEFORE USING THIS AIR PURIFIER AND SAVE THESE IMPORTANT INSTRUCTIONS

1. This Air Purifier is designed for use on a flat, level surface and may not work properly on an uneven surface. **ALWAYS** place this Air Purifier on a firm, level surface. **ALWAYS** place the Air Purifier at least six (6) inches away from walls and heat sources such as stoves, radiators, or heaters.
2. Place the Air Purifier in an area that is out of the reach of children.
3. Before using the Air Purifier, extend the cord and inspect for any signs of damage. **DO NOT** use the product if the cord has been damaged.
4. This product has a polarized plug (one blade is wider than the other) as a safety feature. This plug will fit into a polarized outlet only one way. If the plug does not fit fully into the outlet, reverse the plug. If it still does not fit, contact a qualified electrician. **DO NOT** attempt to defeat or override this safety feature.
5. **ALWAYS UNPLUG** the Air Purifier when it is not in operation, while the filter is being changed, and while it is being cleaned.
6. **DO NOT** tilt or move the Air Purifier while it is in operation. Shut off and unplug before moving.
7. **DO NOT** immerse the Air Purifier in water as permanent damage will occur. Refer to and follow the **CLEANING AND FILTER REPLACEMENT** instructions.

Introduction

Thank you for purchasing the **QuietFlo™** True HEPA Air Purifier from Hunter Fan Company. You have purchased our latest development in portable Air Purification Systems. This system has been developed to improve the quality of the air you breathe.

Our **QuietFlo™** True HEPA Air Purifier out performs other air purification systems by quickly and effectively removing dust, smoke, and pollen particles. Room air is pulled in through the front grille and cleaned across the HEPA filter. Clean air is then released out the top grille.

The HEPA filter will remove 99.97% of particles 0.3 microns in size from air that passes through the filter.

The activated carbon pre-filter helps remove cooking, smoke, and pet odors from the air. It also traps lint, hair, and large particles, which helps improve the life and performance of the HEPA filter.

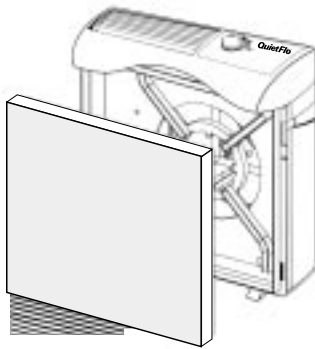

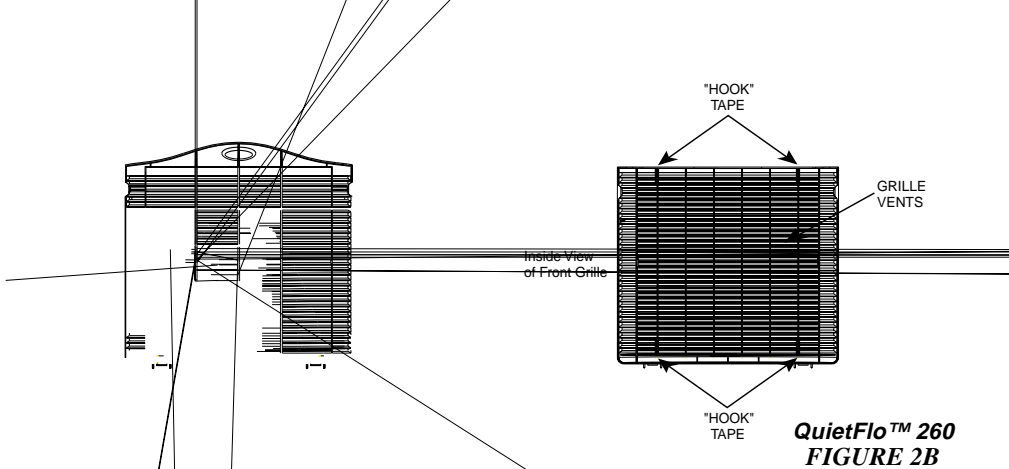

Operating Your Air Purifier

Models 30210 and 30260

On/Speed Control: Rotate this knob to turn the unit 'on'. The knob rotates through "Off", "Low", "Medium" and "High". Keep rotating the knob to change speeds until you reach the speed you desire. When the power is "on", the red light will be illuminated.

Cleaning And Filter Replacement

(These Air Purifiers use Replacement HEPA Filter #30940 and Activated Carbon Pre-Filter #30903)

1. Clean the outside of the unit with a soft, damp cloth. The front grille can be removed and cleaned in soapy water. Remove the pre-filter before cleaning the front grille.
2. **At least every 90 days, open the front grille, remove the carbon pre-filter, and replace it.** This is necessary to maintain proper odor-removing and overall filtration performance. If necessary, it can be changed more often. Mark the new filter installation sticker included with the new carbon pre-filter. **Be sure to remove any plastic wrapping that may be on the new filter before you place it into the Air Purifier.**
3. While replacing the pre-filter, you should view the condition of the **QuietFlo™** HEPA Filter. Compare the filter to the color coded chart that is on the inside of the housing. If the filter matches the dark color on the chart, you should remove the filter and replace it with a new filter. Mark the new filter installation sticker included with the new **QuietFlo™** HEPA Filter. **Depending on use and environment, the HEPA Filter should last one year.**
4. If you notice a decrease in air output or an increase in noise, the HEPA Filter may be clogged. Replace it with a new **QuietFlo™** HEPA Filter.

Replacement Filters:

To obtain a replacement filter for your Air Purifier, call 1-800-4Hunter for your nearest retailer or Hunter Customer Service at 901-245-9222. Please be prepared to tell the operator the model number of your Air Purifier and the model number of the filter you need to replace. These Air Purifiers use Model 30940 Replacement HEPA Filters and Model 30903 Pre-Filters. Visit our website at www.HunterFan.com.

The above is an illustration of how the **QuietFlo™** True HEPA Air Purifier works. Dust and other irritants are pulled into the air purification system and cleaned through the HEPA Filter. Clean, purified air is released into the room.

Other Home Comfort Products from Hunter

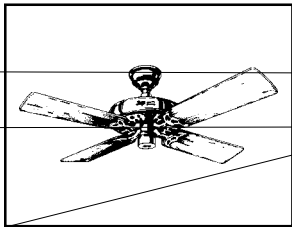

Hunter Original®

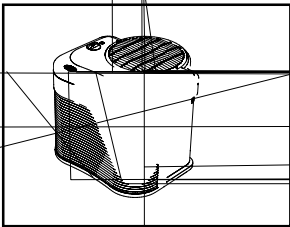

The Care-Free Humidifier™

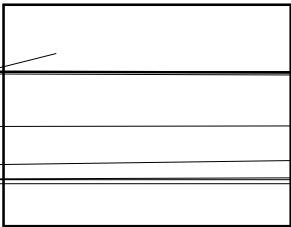

Programmable Thermostat

To learn more about Hunter Fan Company products, please see our web page at:

WWW. HUNTERFAN.COM

Hunter Fan Company

QuietFlo™ True HEPA Air Purifier

5 YEAR LIMITED WARRANTY

The Hunter Fan Company makes the following limited warranty to the original residential user or consumer purchaser of the **QuietFlo™ True HEPA Air Purifier**:

If any part of your **QuietFlo™ True HEPA Air Purifier** motor fails during the first five (5) years from the date of installation due to a defect in material or workmanship, we will provide a replacement Air Purifier free of charge. Installation is deemed to occur at the date of purchase.

If the Air Purifier cord, ionizer, or front grille fails any time within one (1) year after installation due to a defect in material or workmanship, we will replace or, at our option, repair the unit free of charge at our nearest service centre or at our Service Department in Memphis, Tennessee. You will be responsible for all parts and labor costs after this one-year period.

USE OF A NON-HUNTER FILTER WILL INVALIDATE THIS WARRANTY. IF THE ORIGINAL RESIDENTIAL USER OR CONSUMER PURCHASER CEASES TO OWN THE AIR PURIFIER, THIS WARRANTY AND ANY IMPLIED WARRANTY WHICH THEN REMAINS IN EFFECT, INCLUDING BUT NOT LIMITED TO ANY IMPLIED WARRANTY OF MERCHANTABILITY OR FITNESS FOR A PARTICULAR PURPOSE, ARE VOIDED.

NO WARRANTY, EXPRESSED OR IMPLIED, INCLUDING ANY WARRANTY OF MERCHANTABILITY OR FITNESS FOR A PARTICULAR PURPOSE, IS MADE IN RESPECT TO THE FILTER MATERIAL OR CARBON FILTER.

THIS WARRANTY IS IN LIEU OF ALL OTHER EXPRESS WARRANTIES. THE DURATION OF ANY IMPLIED WARRANTY INCLUDING BUT NOT LIMITED TO ANY IMPLIED WARRANTY OF MERCHANTABILITY OR FITNESS FOR A PARTICULAR PURPOSE, IN RESPECT TO THE MOTOR IS EXPRESSLY LIMITED TO THE PERIOD OF THE EXPRESS WARRANTY SET FORTH ABOVE.

This warranty is voided if the air purifier is not purchased and used in the USA or Canada.

This warranty excludes and does not cover defects, malfunctions or failures of the Air Purifier which were caused by repairs by persons not authorized by us, use of parts or accessories not authorized by us, mishandling, modifications, or damage to the Air Purifier while in your possession, or unreasonable use, including failure to provide reasonable and necessary maintenance. This warranty does not cover Air Purifiers used in commercial applications. There are no express or implied warranties as to commercial purchasers or users.

To obtain service, contact the nearest Hunter authorized service centre or the Hunter Fan Company Service Department, 2500 Frisco Avenue, Memphis, Tennessee 38114, 901-248-2222. For the name of our nearest authorized Hunter Fan Company Service Centre, write to the Hunter Fan Company at the preceding address. You will be responsible for insurance and freight or other transportation to our factory service center. We will return the Air Purifier freight prepaid. The Air Purifier should be properly packaged to avoid damage in transit since we will not be responsible for any such damage. Proof of purchase is required when requesting warranty service. The purchaser must present sales receipt or other document that establishes proof of purchase.

IN NO EVENT SHALL HUNTER COMPANY BE LIABLE FOR DIRECT, INDIRECT, SPECIAL CONSEQUENTIAL OR INCIDENTAL DAMAGES IN EXCESS OF THE PURCHASE PRICE OF THE AIR FILTER. YOUR SOLE REMEDY WILL BE REPAIR OR REPLACEMENT AS PROVIDED IN SECTION 2.

SOME AMERICAN STATES AND CANADIAN PROVINCES DO NOT ALLOW:

- LIMITATIONS ON HOW LONG AN IMPLIED WARRANTY LASTS;
- THE EXCLUSION OR LIMITATION OF DIRECT, INDIRECT SPECIAL, INCIDENTAL OR CONSEQUENTIAL DAMAGES;

SO THE ABOVE LIMITATIONS MAY NOT APPLY TO YOU.

THIS WARRANTY GIVES YOU SOME LEGAL RIGHTS AND YOU MAY ALSO HAVE OTHER RIGHTS WHICH VARY FROM STATE TO STATE OR PROVINCE TO PROVINCE.



Free Manuals Download Website

<http://myh66.com>

<http://usermanuals.us>

<http://www.somanuals.com>

<http://www.4manuals.cc>

<http://www.manual-lib.com>

<http://www.404manual.com>

<http://www.luxmanual.com>

<http://aubethermostatmanual.com>

Golf course search by state

<http://golfingnear.com>

Email search by domain

<http://emailbydomain.com>

Auto manuals search

<http://auto.somanuals.com>

TV manuals search

<http://tv.somanuals.com>