

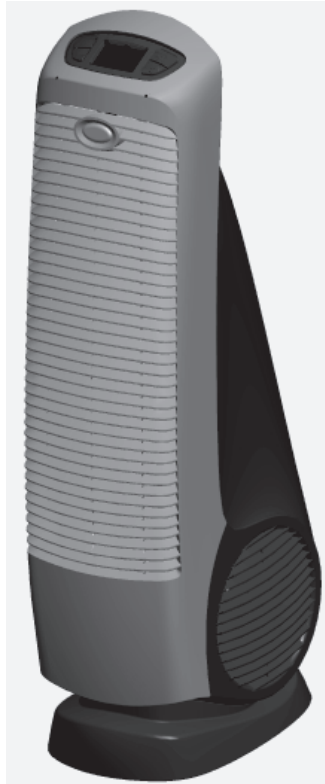

QuietFlo® Plus

Air Purifier



ENGLISH
See page 1

FRANÇAIS
Voir page 17





Models 30785 & 37785

Replacement Filter Information

Model	Carbon Odor Filter	QuietFlo® Filter
37785	30901	30943

www.hunterfan.com

Table of Contents

Safety Instructions	3
Introduction	3
 Description of Air Filtration System	
How the Air Purifier Works	4
Air Purifier Components	4
Display and Control Keys	5
 Operation	
Initial Operation	6
Locking/Unlocking the Keypad	8
Filter Life Counters	9
Resetting the Air Purifier	9
 Air Purifier Maintenance	
Cleaning Your Air Purifier	10
Cleaning the Pre-Filters & Changing the Carbon Odor Filter	10
Changing the QuietFlo® Main Filter	11
Obtaining Replacement Filters	12
 Troubleshooting	
Problem and Solutions	13
Technical Support	13
 Warranty Information	14

SAFETY INSTRUCTIONS

IMPORTANT!

READ ALL INSTRUCTIONS BEFORE USING THIS Air Purifier.

1. This Air Purifier is designed for use on a flat level floor and may not work properly on an uneven floor. ALWAYS place the Air Purifier on a firm level floor. ALWAYS place the Air Purifier at least six (6) inches away from walls and heat sources such as stoves, radiators, or heaters.
2. Place the Air Purifier in an area that is out of the reach of children.
3. Before using the Air Purifier, extend the cord and inspect for any signs of damage. DO NOT use the product if the cord has been damaged.
4. This product has a polarized plug (one blade is wider than the other) as a safety feature. This plug will fit into a polarized outlet only one way. If the plug does not fit fully into the outlet, reverse the plug. If the plug still does not fit, contact a qualified electrician. DO NOT attempt to defeat or override this safety feature.
5. ALWAYS UNPLUG the Air Purifier while it is being cleaned.
6. DO NOT move or tilt the Air Purifier while it is in operation. Turn off and unplug before moving.
7. DO NOT immerse the Air Purifier in water at any time because permanent damage will occur. To properly clean your Air Purifier, follow the instructions in the Maintenance section of this manual (pg. 10).

READ AND SAVE THESE INSTRUCTIONS

Introduction

Thank you for purchasing the QuietFlo® Plus Air Purifier from Hunter Fan Company. You have purchased our latest development in portable air purification which has been designed to improve the quality of the air that you breathe. The following innovative features are included in your Hunter Air Purifier.

- High Particulate Efficiency: The QuietFlo® filter will remove 99.97% of 0.3 micron particles from the air that passes through the filter.
- Odor Removal: The activated carbon filter helps remove odors such as cooking, smoke, and pet smells from the air.
- Quiet: The Air Purifier has been designed to operate quietly and efficiently. You can choose among three speeds to best meet your needs at different times.
- Filter Counters: Filter maintenance is critical to the performance of the Air Purifier. To help you determine when to change the carbon filter, the pre-filters and QuietFlo® filter, the unit has built in life counters that keep track of the life remaining of each filter.



Description of Air Filtration System

How the QuietFlo® Plus Air Purifier System Works

As the air is pulled into the Air Purifier, the Pre-Filters capture large particles. Then, the air travels through the QuietFlo® Main Filter where the smaller particles are collected. Odors are removed as the air passes through the Carbon Odor Filter. Finally, the clean, purified air is released back into the room.

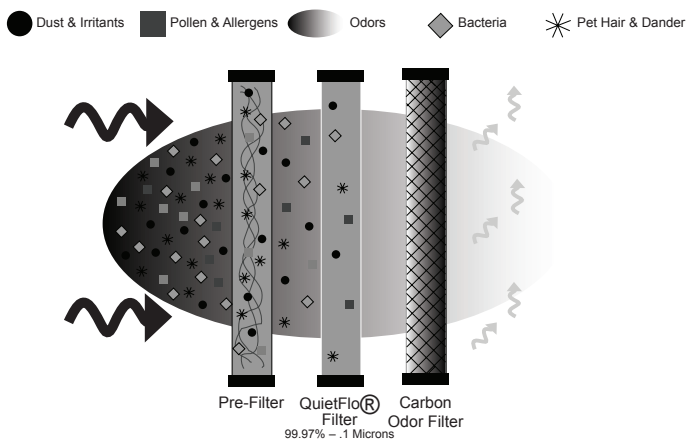

Fig. 1 - Illustration of the Air Filtration System

Air Purifier Components

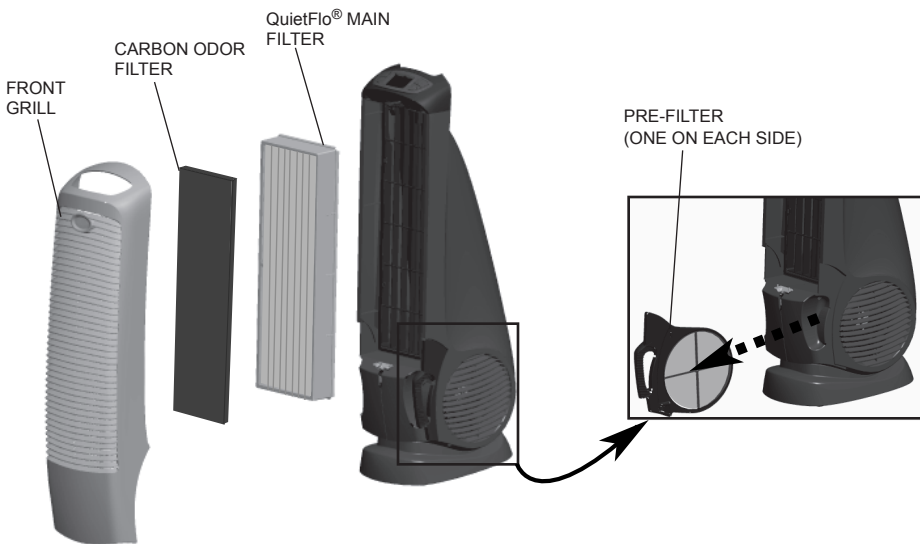

Fig. 2 - Air Purifier Components

Description of Air Filtration System



Display and Control Keys

The display and control keys allow for easy operation of the Air Purifier.

FAN SPEED CONTROL: Sets the fan speed.



PRE-FILTERS & CARBON ODOR FILTER RESET: Resets the Pre-Filter and Carbon Filter Life Counter.

QuietFlo® MAIN FILTER RESET: Resets the QuietFlo® Main Filter Life Counter.

ON / OFF KEY: Turns the fan on and off. **NOTE:** The ON / OFF key operates the fan ONLY. The LCD Display will remain on even when the fan is off.

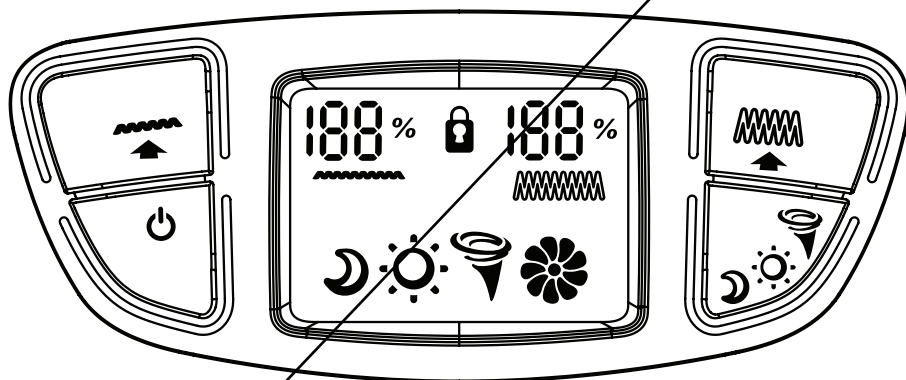



Initial Operation

This section provides basic instructions on the use of your Air Purifier. After following these initial directions, please continue reading this booklet to learn how to operate the more advanced features of your Air Purifier.

Basic Operation of the Air Purifier:

1. Take the Air Purifier out of the box and remove the clear plastic protective bag. Place the unit on a firm level floor.
2. Before turning on the Air Purifier, you need to confirm that the QuietFlo® Main Filter is firmly in place and has not become loose during shipping. To check the filter, remove the front grill by placing your fingers under the grill release handle and pulling the handle up. Refer to Figs. 4 and 5.



Fig. 4



Fig. 5

3. Inspect the filter to ensure the bottom of the filter is secure and the top of the filter is behind the filter tab. Refer to Fig. 6.



Fig. 6



4. If the filter is secure, place the front grill back onto the unit. Place the grill over the front of the Air Purifier and lower it into position. Refer to Fig. 7.
NOTE: This unit will not operate unless the grill is in the correct position. If the filter is not secure, refer to the section Changing the QuietFlo® Main Filter (pg. 14).

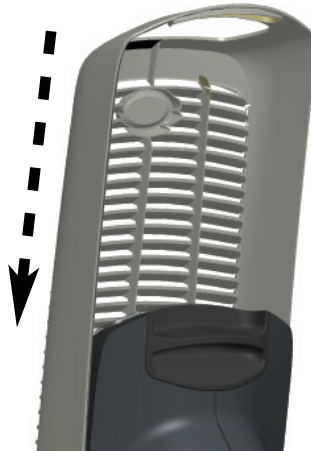
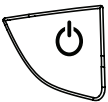

Fig. 7



5. Plug the unit into a 120V electrical outlet and press the ON/OFF Key. The fan will begin to blow air from the front of the unit.



6. Use the FAN SPEED CONTROL Key to set the fan speed. Refer to Fig. 8.

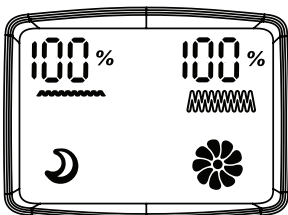

SLEEP (SLOW)

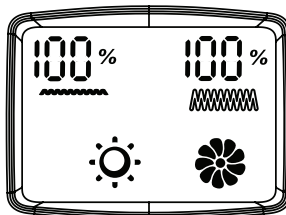

ACTIVE (MEDIUM)

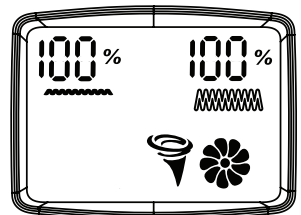

TURBO CLEAN
(FAST)

Fig. 8



Locking/Unlocking the Keypad

Once you enter the desired speed, you may want to lock the keypad to prevent accidental changing of the speed. When the keypad is locked, all keys will be disabled. If you press a key, the Keypad Locked Indicator will be displayed on the screen for 1-2 seconds.

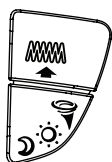

1. To lock the keypad, press and hold the QuietFlo® Main Filter Reset key and the Fan Speed Control key simultaneously for 2-3 seconds. The Keypad Locked Icon will appear on the display. Refer to Fig. 9. After releasing the keys, the Keypad Locked Icon will disappear.

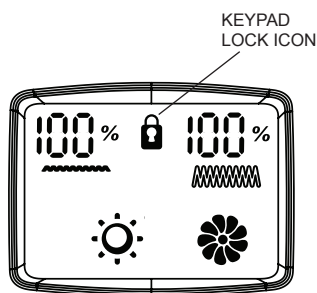
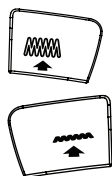

Fig. 9

2. To unlock the key pad, press and hold the QuietFlo® Main Filter Reset key and the Fan Speed Control key simultaneously for 2-3 seconds. The Keypad Locked Icon will disappear and the keypad will be functional.

Using the LCD Backlight



1. To turn on the LCD Backlight, press and hold the Pre-Filter and the Main Filter keys for 3 seconds. To turn the LCD Backlight off, repeat the process.



Filter Life Counters

The Pre-Filters, Carbon Odor Filter, and QuietFlo® Main Filter are critical to the proper operation of the Air Purifier. To help you know when to clean and change the filters, your Hunter Air Purifier has Filter Life Counters that will monitor the life of your filter. Although the exact life of the filters depends on the environment, the table below gives typical usage times of the filters.

Table 1: Typical Usage Times of the Filters

Filter Type	Typical Usage
QuietFlo® Main Filter	8000 hours
Pre-Filter / Carbon Odor Filter	2000 Hours

When the Pre-Filters & Carbon Odor Filter Life Counter reaches 0%, clean the Pre-Filters and change the Carbon Odor Filter. Replace the QuietFlo® Main Filter when the QuietFlo® Main Filter Life Counter reaches 0%.

The values of the Filter Life Counters are stored in the Air Purifier's memory. The unit may be unplugged and moved or stored without losing the Pre-Filter and Filter Counter values.

To properly track filter life, reset the Filter Life Counters each time the filters are changed or cleaned. Refer to Pre-Filters & Carbon Odor Filter (pg. 10) or Changing the QuietFlo® Main Filter (pg. 11) sections for instructions on how to reset the counters.

Resetting the Air Purifier

In the unusual situation that the unit or the display is exhibiting erratic behavior, you may want to reset the Air Purifier. If you still have problems after resetting the Air Purifier, please contact Hunter for additional assistance (refer to Technical Support, pg. 14).

To Reset the Air Purifier:

1. Unplug the unit for at least 30 seconds.
2. Plug the unit back in.



Cleaning Your Air Purifier

Proper maintenance of your Hunter Air Purifier will help ensure years of trouble free service.

Follow these steps to properly maintain your Air Purifier:

1. Approximately every 90 days, the outside of the unit should be cleaned with a soft, damp cloth.
2. If needed, the Front Grill can be removed from the unit and cleaned with soapy water. NOTE: Remove the Carbon Odor Filter before exposing the Front Grill to water.
3. Follow the instructions in Cleaning the Pre-Filters and Changing the Carbon Odor Filter (pg. 10) and Changing the QuietFlo® Main Filter (pg. 11) to determine when and how to replace the filters.

NOTES:

- The Air Purifier must be unplugged during the cleaning process.
- Be sure the unit is completely dry before plugging in and using.
- Never immerse unit in water.

Cleaning the Pre-Filters and Changing the Carbon Odor Filter

When the Pre-Filter exceeds 2000 hours (refer to Filter Life Counters for additional information, pg. 9), the Pre-Filter indicator will turn on as a reminder that you should clean the Pre-Filter and change the Carbon Odor Filter. To maintain proper odor-removing capability and overall filtration performance, the Pre-filters should be cleaned and the Carbon Odor filters replaced every 2000 hours (approximately 3 months of use). If necessary, clean the pre-filter and change the odor filter more often. Proper maintenance of the pre-filter will help extend the life of the QuietFlo® filter. Refer to Obtaining Replacement Filters (pg. 13) if you need help finding replacement filters.

To clean the Pre-Filters, Change the Carbon Odor Filter, and reset the Pre-Filters & Carbon Odor Filter Life Counter:

1. First, turn off and unplug the Air Purifier.
2. Next, remove the front grill. Refer to Figs. 4 and 5 (pg. 6).
3. Remove the Pre-Filters. Refer to Fig.2, pg. 4. Use a vacuum cleaner to remove dust from them. Then, reinsert the Pre-Filters into the Air Purifier.
4. The Carbon Odor Filter is held to the back of the Front Grill with four hook-and-pile fasteners. Peel off the old Carbon Odor Filter.
5. If needed, use a soft damp cloth to wipe off the Front Grill. Gently press a new filter into place.



6. Place the Front Grill back onto the unit.
7. Plug in the Air Purifier.
8. To reset the Pre-Filters & Carbon Odor Filter Life Counter to zero, press and hold the Pre-Filters & Carbon Odor Filter Reset Key for three seconds. When the display shows 100%, release the Key. The Counter is now reset.

Changing the QuietFlo® Main Filter

When the QuietFlo® Main Filter Life Counter reaches 0% (approximately 10 to 12 months of use), you should replace the filter. Refer to Filter Life Counters for additional information, pg. 9. The proper time to change the filter depends on usage and the environment. Generally, if you notice a decrease in air output or an increase in noise at any time during normal operation, the filter may be clogged. Replace the filter to return to normal operation.

To change the filter and reset the Filter Life Counter:

1. First, turn off and unplug the Air Purifier.
2. Next, remove the Front Grill. Place your fingers under the Grill Release Handle and pull up. Refer to Figs. 4 and 5 (pg. 6).
3. Lift the Filter Tab and gently pull the filter out of the unit. Refer to Fig. 6. While removing the filter, note the filter's orientation - the new filter will be installed with the same orientation. Refer to Fig. 10. Once removed, the used filter can be discarded.
4. To install a new filter, position the filter with its rim facing the unit. Refer to Fig. 10.

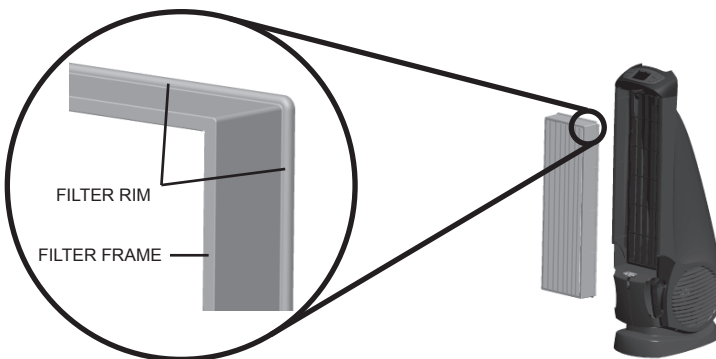

Fig. 10



5. Place the bottom of the filter rim behind the ridges on each side of the bottom of the unit. Refer to Fig. 11.

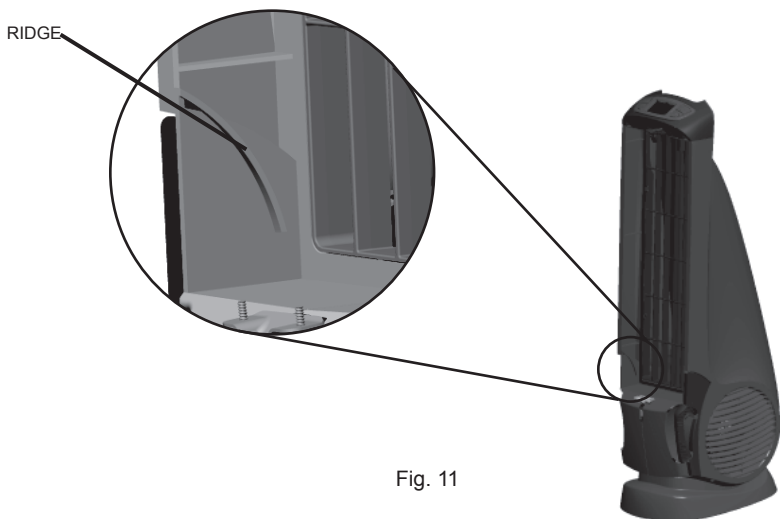

Fig. 11

6. Lift the Filter Tab and press the top of the filter into the Air Purifier. To avoid damaging the filter, you should press only on the filter's frame. When the new filter is in place, release the Filter Tab.
7. Place the front grill back onto the unit. Refer to Figs. 7, pg. 7. NOTE: This unit will not operate unless the grill is in the correct position.
8. Plug the unit in and continue operating it normally.
9. To reset the QuietFlo® Main Filter Life Counter to zero, press and hold the QuietFlo® Main Filter Life Counter Reset Key for three seconds. When the display shows 100%, release the Key. The Counter is now reset.

Obtaining Replacement Filters

To obtain replacement filters for your Air Purifier, first determine your model number by looking at the information label on the bottom of the Air Purifier. The model number will be listed on the label. Then, call 1-800-4HUNTER for your nearest retailer or Hunter Customer Service at 1-800-313-3326 (CAN 1-888-855-8300) to order directly. To order online, visit our Website at www.hunterfan.com. To ensure that you obtain the correct filters, please find your model number below that specifies the correct replacement filters.

Hunter Air Purifier Model No.:	37785
Carbon Odor Filter Replacement Model No.:	30901
HEPAtech® Filter Replacement Model No.:	30943



Problem	Solutions
1. No display or operation.	<ul style="list-style-type: none"> • Confirm that the unit is plugged in. • Check the installation of the front grill. • Reset the Air Purifier. (See Resetting the Air Purifier on pg. 9.)
2. Erratic Operation.	<ul style="list-style-type: none"> • Reset the Air Purifier. (See Resetting the Air Purifier on pg. 9.)
4. Unit has reduced air flow or increased noise.	<ul style="list-style-type: none"> • The filters are clogged and should be cleaned/ changed. (Refer to Cleaning the Pre-filters and Changing the Carbon Odor Filter on pg. 10, and QuietFlo® Main Filter on pg, 11.)

Technical Support

If you have any additional questions or problems with your Hunter Air Purifier, please call 1-888-830-1326 from 8:00 am to 5:00 pm Central Time or contact us over the Internet at www.hunterfan.com.



Warranty

Hunter Fan Company QuietFlo® Plus Air Purifier 5 YEAR LIMITED WARRANTY

The Hunter Fan Company makes the following limited warranty to the original residential user or consumer purchaser of the QuietFlo® Plus Air Purifier:

If any part of your QuietFlo® Plus Air Purifier motor or control panel fails during the first five (5) years from the date of installation due to a defect in material or workmanship, we will provide a replacement Air Purifier free of charge. Installation is deemed to occur at the date of purchase.

If the Air Purifier cord or front grill fails any time within one (1) year after installation due to a defect in material or workmanship, we will replace or, at our option, repair the unit free of charge at our nearest service center or at our Service Department in Memphis, Tennessee. You will be responsible for all parts and labor costs after this one-year period.

USE OF A NON-HUNTER FILTER WILL INVALIDATE THIS WARRANTY. IF THE ORIGINAL RESIDENTIAL USER OR CONSUMER PURCHASER CEASES TO OWN THE Air Purifier, THIS WARRANTY AND ANY IMPLIED WARRANTY WHICH THEN REMAINS IN EFFECT, INCLUDING BUT NOT LIMITED TO ANY IMPLIED WARRANTY OF MERCHANTABILITY OR FITNESS FOR A PARTICULAR PURPOSE, ARE VOIDED.

NO WARRANTY, EXPRESSED OR IMPLIED, INCLUDING ANY WARRANTY OF MERCHANTABILITY OR FITNESS FOR A PARTICULAR PURPOSE, IS MADE IN RESPECT TO THE FILTER MATERIAL OR CARBON FILTER.

THIS WARRANTY IS IN LIEU OF ALL OTHER EXPRESS WARRANTIES. THE DURATION OF ANY IMPLIED WARRANTY INCLUDING BUT NOT LIMITED TO ANY IMPLIED WARRANTY OF MERCHANTABILITY OR FITNESS FOR A PARTICULAR PURPOSE, IN RESPECT TO THE MOTOR IS EXPRESSLY LIMITED TO THE PERIOD OF THE EXPRESS WARRANTY SET FORTH ABOVE.

This warranty is voided if the Air Purifier is not purchased and used in the USA or Canada.

This warranty excludes and does not cover defects, malfunctions or failures of the Air Purifier which were caused by repairs by persons not authorized by us, use of parts or accessories not authorized by us, mishandling, modifications, or damage to the Air Purifier while in your possession, or unreasonable use, including failure to provide reasonable and necessary maintenance. This warranty does not cover Air Purifiers used in commercial applications. There are no express or implied warranties as to commercial purchasers or users.

To obtain service, contact the Hunter Fan Company Service Department, 2500 Frisco

Avenue, Memphis, Tennessee 38114, 1-888-830-1326. You will be responsible for insurance and freight or other transportation to our factory service center. We will return the Air Purifier freight prepaid. The Air Purifier should be properly packaged to avoid damage in transit since we will not be responsible for any such damage. Proof of purchase is required when requesting warranty service. The purchaser must present sales receipt or other document that establishes proof of purchase.

IN NO EVENT SHALL HUNTER FAN COMPANY BE LIABLE FOR DIRECT, INDIRECT, SPECIAL CONSEQUENTIAL OR INCIDENTAL DAMAGES IN EXCESS OF THE PURCHASE PRICE OF THE Air Purifier. YOUR SOLE REMEDY WILL BE REPAIR OR REPLACEMENT AS PROVIDED ABOVE.

SOME AMERICAN STATES AND CANADIAN PROVINCES DO NOT ALLOW:

- LIMITATIONS ON HOW LONG AN IMPLIED WARRANTY LASTS;
- THE EXCLUSION OR LIMITATION OF DIRECT, INDIRECT SPECIAL, INCIDENTAL OR CONSEQUENTIAL DAMAGES;

SO THE ABOVE LIMITATIONS MAY NOT APPLY TO YOU.

THIS WARRANTY GIVES YOU SPECIFIC LEGAL RIGHTS AND YOU MAY ALSO HAVE OTHER RIGHTS WHICH VARY FROM STATE TO STATE OR PROVINCE TO PROVINCE.

Home Comfort Products from Hunter

The **Free-Free** Product Line
Hunter™ Great

to learn more about Hunter Fan Company, please visit our Website

www.hunterfan.com

Free Manuals Download Website

<http://myh66.com>

<http://usermanuals.us>

<http://www.somanuals.com>

<http://www.4manuals.cc>

<http://www.manual-lib.com>

<http://www.404manual.com>

<http://www.luxmanual.com>

<http://aubethermostatmanual.com>

Golf course search by state

<http://golfingnear.com>

Email search by domain

<http://emailbydomain.com>

Auto manuals search

<http://auto.somanuals.com>

TV manuals search

<http://tv.somanuals.com>