









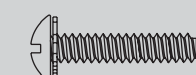
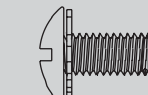
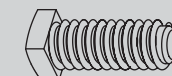

Hardware

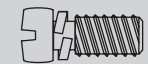
(Drawn to Scale)

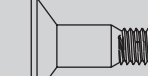
-  **x 2** 3" Wood Screw
-  **x 4** Flat Washer
-  **x 2** 1.5" Wood Screw
-  **x 4** Locking Screw
-  **x 3** Canopy Screw
-  **x 1** Set Screw
-  **x 4** Mounting Isolator
-  **x 11** Screw, Blade Iron Armature
-  **x 16** Blade Grommet
-  **x 16** Screw, Blade Assembly

 **x 1** Balancing Kit

 **x 4** Wire Connector

 **x 3** Screw, Switch Housing Assembly

 **x 3** Screw, Machine, 6-32

Fan Parts

(Not Drawn to Scale)

Hanger Bracket Assembly

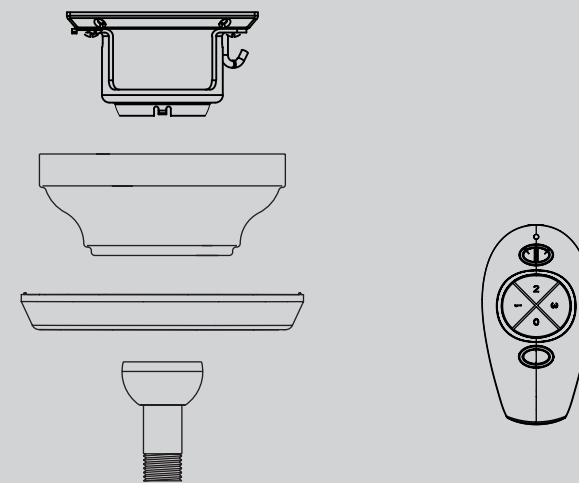

Blade Assembly

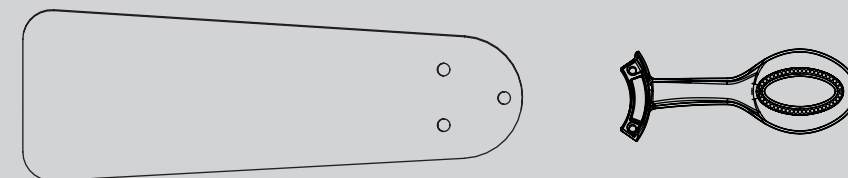

Switch Housing Assembly

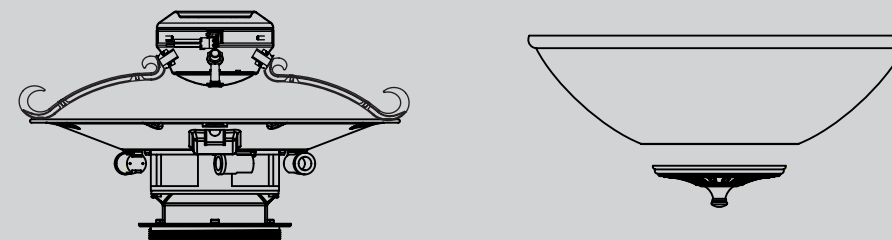

PARTS GUIDE



SINCE 1886

STOP

Using this Parts Guide, make sure all parts are included in the box.

If parts are missing, DO NOT RETURN

THIS ITEM TO THE STORE, call 888-830-1326 for assistance.

THIS PARTS GUIDE IS FOR REFERENCE ONLY.

REFER TO THE INSTALLATION MANUAL FOR FULL ASSEMBLY INSTRUCTIONS.

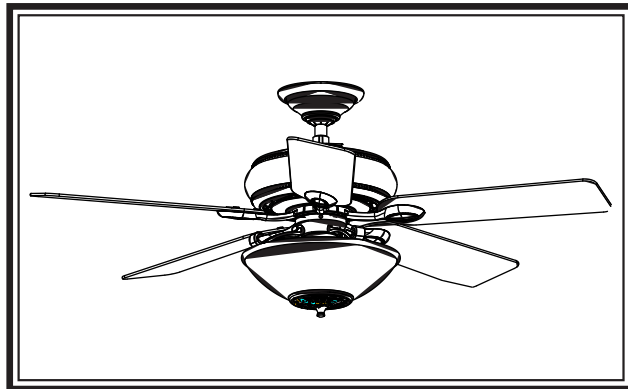





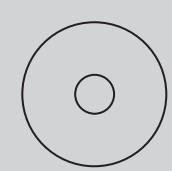

Parts List

Item Name	Qty	Part #
* Hanging System Kit		
Ceiling Plate		96970-01
Canopy		
Canopy Trim Ring		
Hanger Ball / Downrod Assembly		
Setscrew		
Canopy Screw		
Wood Screw		
Wood Screw		
Flat Washer		
Mounting Isolator		
* Locking Screw		
Heater Vent	1	97682-01
Blade Iron Set	1	97282-05
Blade Iron Assembly	5	97282-01
Blade Set	1	86269-45
Screw, Blade Iron Armature	11	63755-05
Hardware Kit	1	97830-00-860
Blade Grommet		
Blade Assembly Screw		
Screw, Machine, 6-32		
Wire Connector		
Screw, Switch Housing Assembly		
Balancing Kit	1	07570-01
Remote Control Receiver	1	87783-01
Remote Control Transmitter	1	87782-01
Finial	1	87947-01
Globe/Shade	1	87849-01

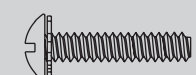
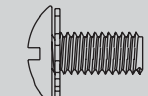
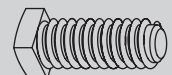
Materiales

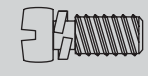
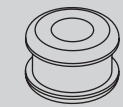
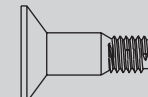
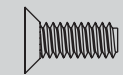
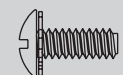
(no dibujados a escala)

	x 2	3" Tornillo, de madera
	x 4	Arandela, plana
	x 2	1.5" Tornillo, de madera
	x 4	Tornillo de fijación
	x 3	Tornillo, de campana
	x 1	Tornillo prisionero
	x 4	Aislador de montaje
	x 11	Tornillo, de armadura de soporte de paleta
	x 16	Arandela de caucho, de paleta
	x 16	Tornillo, de conjunto de paleta
	x 3	Tornillo, del conjunto de la caja del interruptor
	x 3	Tornillo, mecánico, 6-32

 **x 1** Kit de equilibrado

 **x 4** Empalme plástico

Piezas del ventilador

(no dibujadas a escala)

Conjunto del soporte de suspensión

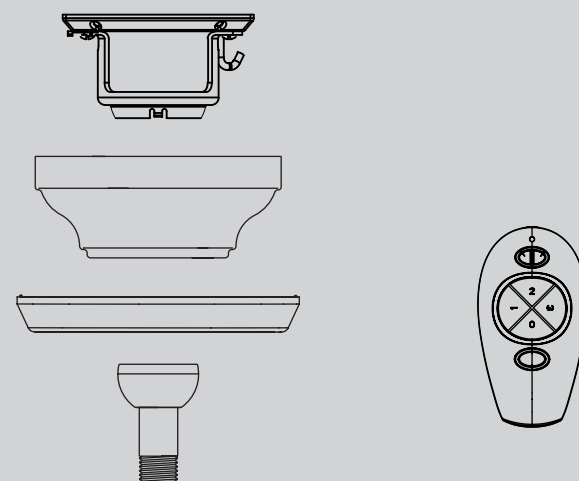

de conjunto de paleta

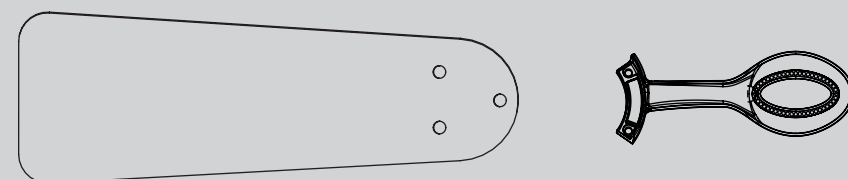

Conjunto del interruptor/ alojamiento

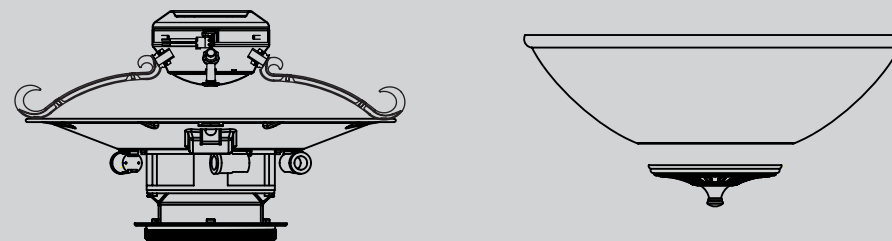

GUÍA DE PIEZAS



SINCE 1886

PARADA

Consulte esta Guía de partes para asegurarse de que todas las partes estén incluidas en la caja.

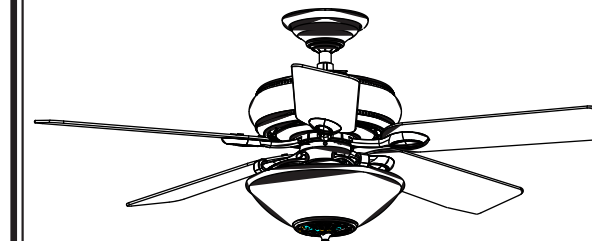

Si falta alguna parte, **NO DEVUELVA ESTE PRODUCTO A LA TIENDA.** Solicite ayuda al 888-830-1326. **ESTA GUÍA DE PARTES SOLAMENTE ES REFERENCIAL. CONSULTE LAS INSTRUCCIONES COMPLETAS DE ENSAMBLAJE EN EL MANUAL DE INSTALACIÓN**

Lista de piezas	No. del modelo	
	21894	
No. del dibujo de ensamblaje		97830-01
Acabado		Bronce nuevo
Nombre del ítem	Cantidad	No. de la pieza
* Kit del sistema de suspensión		96970-01
Placa de techo		
Campana		
Anillo de la moldura de campana		
Bola de suspensión / Conjunto de varilla		
Tornillo prisionero		
Tornillo, de campana		
Tornillo, de madera		
Tornillo, de madera		
Arandela, plana		
Aislador de montaje		
* Tornillo de fijación		
Conducto de calefacción	1	97682-01
Juego de soporte de paletas	1	97282-05
Blade Iron Assembly	5	97282-01
Blade Set	1	86269-45
Screw, Blade Iron Armature	11	63755-05
Hardware Kit	1	97830-00-860
Blade Grommet		
Blade Assembly Screw		
Screw, Machine, 6-32		
Wire Connector		
Screw, Switch Housing Assembly		
Balancing Kit	1	07570-01
Remote Control Receiver	1	87783-01
Remote Control Transmitter	1	87782-01
Finial	1	87947-01
Globo / Pantalla	1	87849-01

Free Manuals Download Website

<http://myh66.com>

<http://usermanuals.us>

<http://www.somanuals.com>

<http://www.4manuals.cc>

<http://www.manual-lib.com>

<http://www.404manual.com>

<http://www.luxmanual.com>

<http://aubethermostatmanual.com>

Golf course search by state

<http://golfingnear.com>

Email search by domain

<http://emailbydomain.com>

Auto manuals search

<http://auto.somanuals.com>

TV manuals search

<http://tv.somanuals.com>