

# Hardware

(Drawn to Scale)

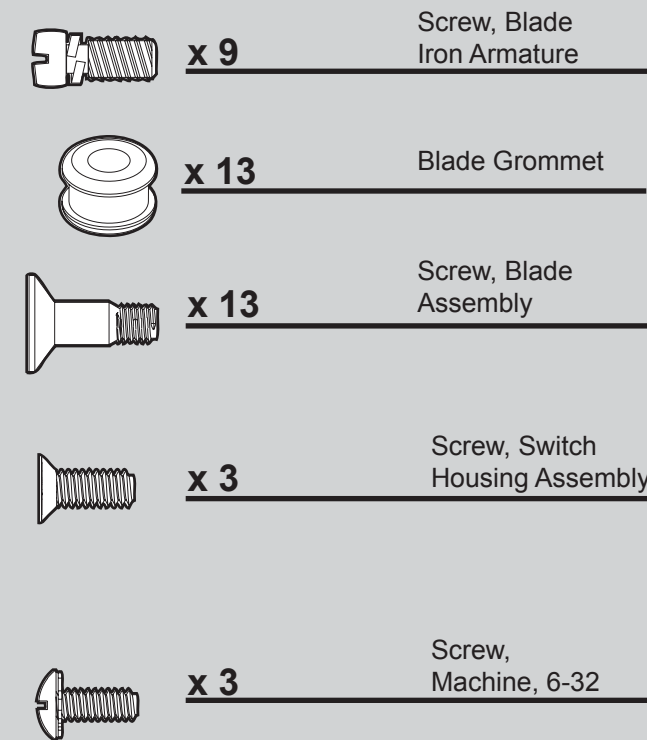
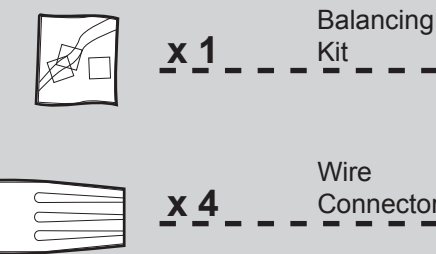
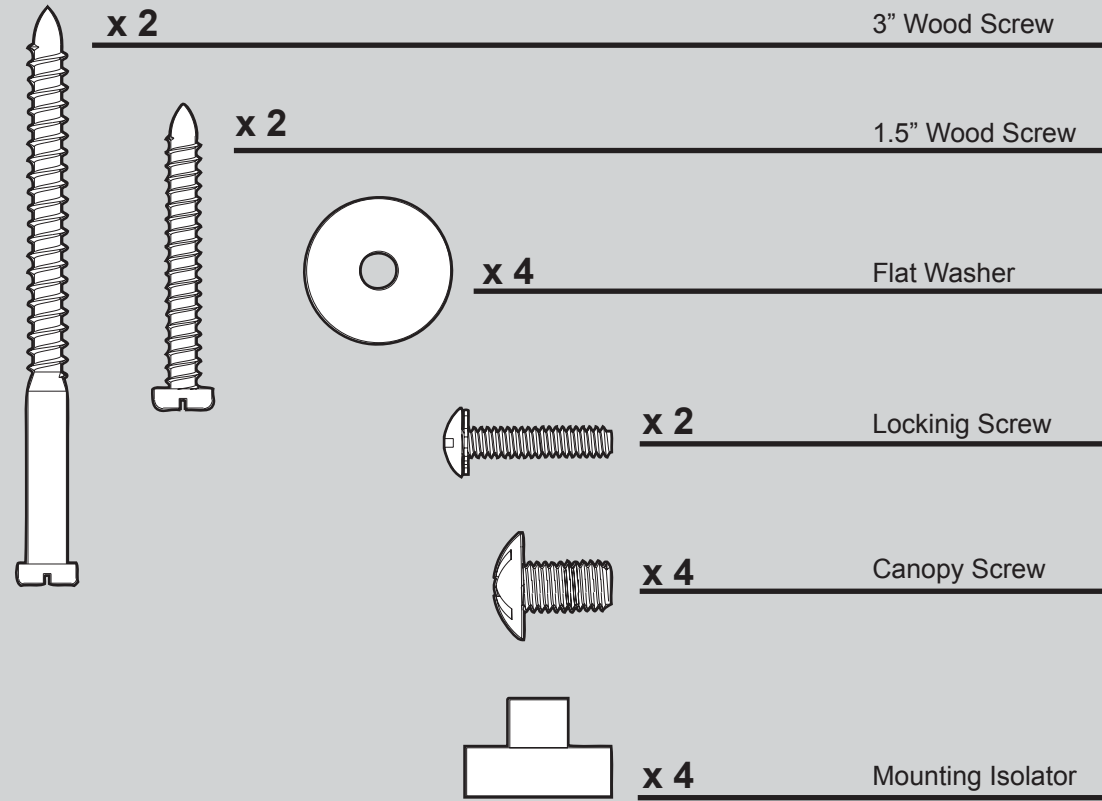

# Fan Parts

(Not Drawn to Scale)

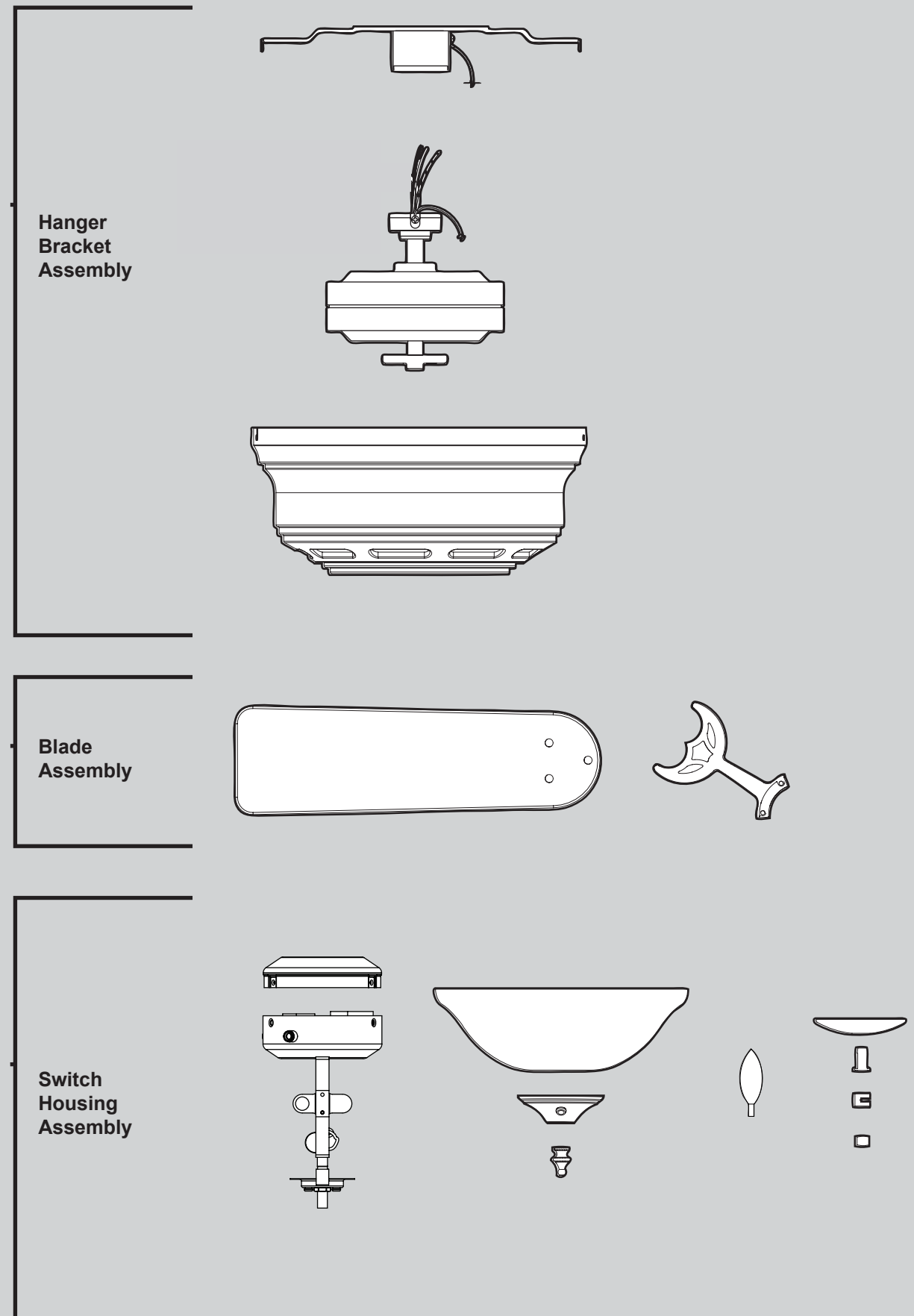

# PARTS GUIDE

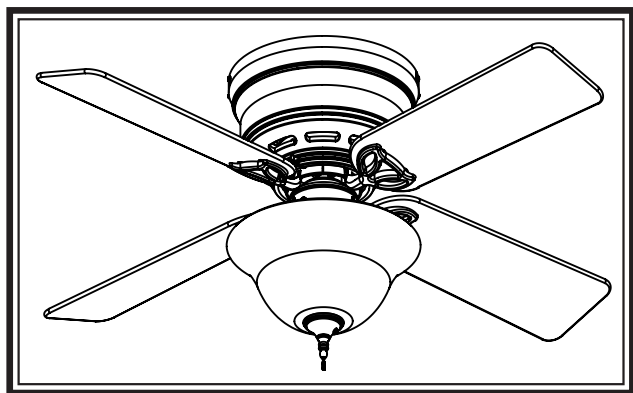

*Hunter*



Using this Parts Guide, make sure all parts are included in the box. If parts are missing, DO NOT RETURN

THIS ITEM TO THE STORE, call 888-830-1326 for assistance.

THIS PARTS GUIDE IS FOR REFERENCE ONLY.

REFER TO THE INSTALLATION MANUAL FOR FULL ASSEMBLY INSTRUCTIONS.

Parts List	Model #	22375	22376
	Asm. Dwg. #	97699-01	97699-02
	Finish	White	New Bronze
Item Name	Qty	Part #	Part #
Hanger Bracket Assembly	1	73846-01	73846-01
Motor Housing	1	92511-01	92511-01
Housing Cover Screw	4	74508-37	74508-37
Switch Housing Assembly	1	99035-03	99035-30
Blade Iron Set	1	92803-04	92803-04
Blade Set	1	88487-01	88487-02
Screw, Blade Iron Armature	9	63755-05	63755-05
Hardware Kit	1	97699-00-860	97699-00-861
Wood Screw			
Flat Washer			
Mounting Isolator			
Locking Screw			
Blade Grommet			
Blade Assembly Screw			
Screw, Machine, 6-32			
Wire Connector			
Screw, Switch Housing Assembly			
Balancing Kit	1	07570-01	07570-01
Cap, Switch Housing	1	73853-01	73853-01
Plug Button	1	73854-01	73854-01
Dummy Terminal, Male	1	08198-01	08198-01
Dummy Terminal, Female	1	08200-01	08200-01
Light bulb / Bulb	2	77646-04	77646-04
Globe/Shade	1	84886-16	84886-05

## Materiales

(no dibujados a escala)

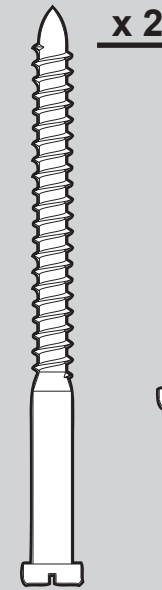

x 2

3" Tornillo, de madera

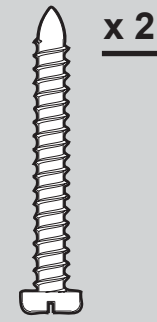

x 2

1.5" Tornillo,  
de madera

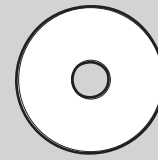

x 4

Arandela, plana

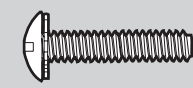

x 2

Tornillo de fijación

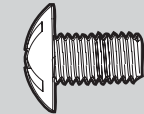

x 4

Tornillo, de campana



x 4

Aislador de montaje



x 9

Tornillo prisionero



x 13

Tornillo, de armadura  
de soporte de paleta

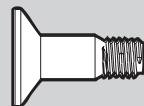

x 13

Tornillo, de conjunto  
de paleta



x 1

Kit de  
equilibrado

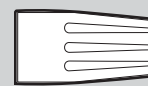

x 4

Empalme  
plástico

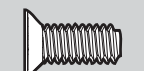

x 3

Tornillo, del conjunto  
de la caja del interruptor

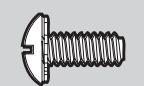

x 3

Tornillo  
mecánico, 6-32

## Piezas del ventilador

(no dibujadas a escala)

Conjunto del  
soporte de  
suspensión

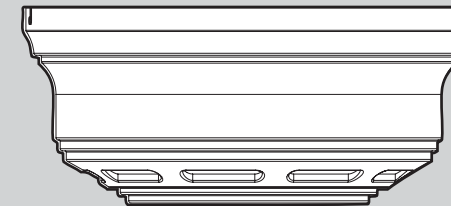
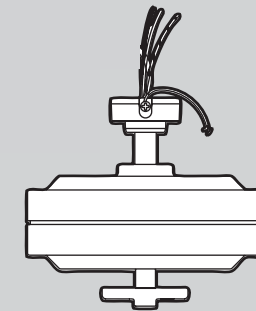
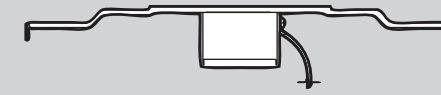

de conjunto  
de paleta

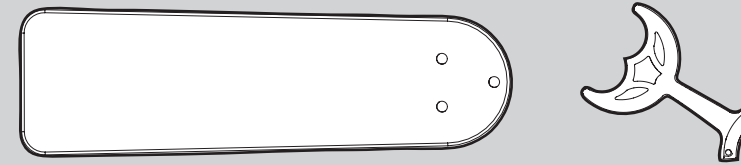

Conjunto del  
interruptor/  
alojamiento

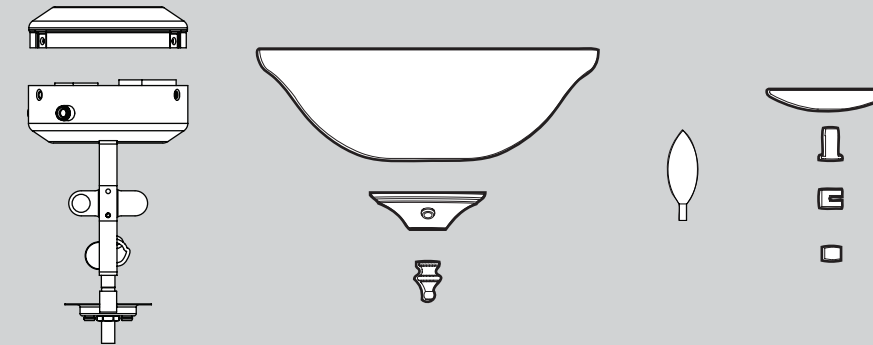

PARADA



# Hunter

Consulte esta Guía de partes para asegurarse de que todas las partes estén incluidas en la caja.

Si falta alguna parte, NO DEVUELVA ESTE PRODUCTO A LA TIENDA. Solicite ayuda al 888-830-1326. ESTA GUÍA DE PARTES SOLAMENTE ES REFERENCIAL. CONSULTE LAS INSTRUCCIONES COMPLETAS DE ENSAMBLAJE EN EL MANUAL DE INSTALACIÓN

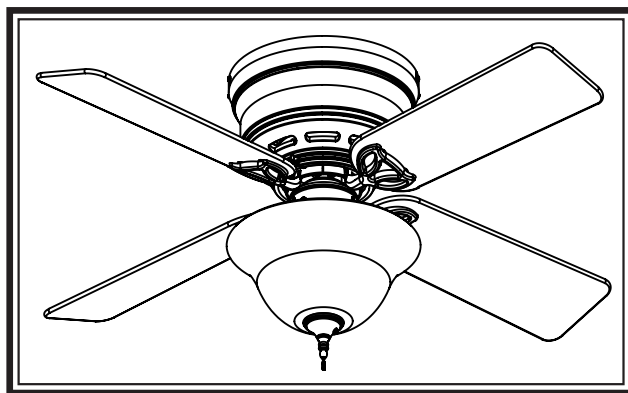

## Lista de piezas

Nombre del ítem	No. del modelo	22375	22376
	No. del dibujo de ensamblaje	97699-01	97699-02
	Acabado	Blanco	Bronce Nuevo
	Cantidad	No. de la pieza	No. de la pieza
Conjunto del soporte de suspensión	1	73846-01	73846-01
Alojamiento del motor	1	92511-01	92511-01
Tornillo de la cubierta del alojamiento	4	74508-37	74508-37
Conjunto del interruptor	1	99035-03	99035-30
Juego de soporte de paletas	1	92803-04	92803-04
Juego de paletas	1	88487-01	88487-02
Tornillo, de armadura de soporte de paleta	9	63755-05	63755-05
Kit de materiales	1	97699-00-860	97699-00-861
Tornillo, de madera			
Arandela, plana			
Aislador de montaje			
Tornillo de fijación			
Arandela de caucho, de paleta			
Tornillo, de conjunto de paleta			
Tornillo, mecánico, 6-32			
Empalme plástico			
Tornillo, del conjunto de la caja del interruptor			
Kit de equilibrado	1	07570-01	07570-01
Tapa, Caja del interruptor	1	73853-01	73853-01
Botón taponador	1	73854-01	73854-01
Terminal simulado, macho	1	08198-01	08198-01
Terminal simulado, hembra	1	08200-01	08200-01
Bombilla	2	77646-04	77646-04
Globo / Pantalla	1	84886-16	84886-05

## Free Manuals Download Website

<http://myh66.com>

<http://usermanuals.us>

<http://www.somanuals.com>

<http://www.4manuals.cc>

<http://www.manual-lib.com>

<http://www.404manual.com>

<http://www.luxmanual.com>

<http://aubethermostatmanual.com>

Golf course search by state

<http://golfingnear.com>

Email search by domain

<http://emailbydomain.com>

Auto manuals search

<http://auto.somanuals.com>

TV manuals search

<http://tv.somanuals.com>