

Evaporative Humidifier

Owner's Guide

English



Model
33116
33118

Form# 44062-01
20101209
©2010 Hunter Fan Co.

SINCE 1886
Hunter[®]

Table of Contents

At A Glance

Warnings and Introduction	3
Know Your Humidifier	4

Using Your Humidifier

Initial Setup and Operation.....	5
----------------------------------	---

Maintenance

Cleaning and Storage	6
----------------------------	---

Humidifier Assistance

Troubleshooting	8
Service Parts and Support	9
Treatments	10

Warranty

3 Year Guarantee	11
------------------------	----

READ AND SAVE THESE INSTRUCTIONS

Important Safety Instructions: Read all instructions before using this humidifier.

- This humidifier may not work properly on an uneven surface. **ALWAYS** place this humidifier on a firm, level and water resistant surface. **ALWAYS** place the humidifier at least six (6) inches away from walls and heat sources such as stoves, radiators or heaters.
- **ALWAYS** place the humidifier in an area that is out of the reach of children.
- Before using the humidifier, extend the cord and inspect for any sign of damage. **DO NOT** use the product if the cord has been damaged.
- This product has a polarized plug as a safety feature (one blade is wider than the other). This plug will fit into a polarized outlet only one way. If the plug does not fully fit into the outlet, reverse the plug. If it still does not fit, contact a qualified electrician. **DO NOT** attempt to defeat or override this feature.
- **ALWAYS unplug and empty** the humidifier when it is not in operation or while it is being cleaned.
- **DO NOT** tilt or move the humidifier while it is in operation. Never move the humidifier while there is water in the tank. Empty the water tank, turn the unit off, and unplug the unit before moving.
- In addition to routine maintenance which may be required, this humidifier requires seasonal cleaning. Refer to and follow the instructions for **“Cleaning and Storage” on page 6.**
- This unit was designed to be used with distilled and/or tap water. **DO NOT** add scented oils, perfumes or fragrance additives to the water.
- Never fill the humidifier tank with hot water. Always use clean, cool tap water.
- The warnings and cautions in this owner’s manual cannot cover all situations, or events that may arise. Common sense and caution should be used by the operator in using this device to prevent injury or accident.

The Hunter® Evaporative Humidifier has a unique, patented design with several innovative features:

- Built-in Antimicrobial Properties – We use Microban® on many of the plastic parts and wick. This helps inhibit the growth of bacteria, mold and fungi that may affect these parts.

NOTE: This product contains antimicrobial properties which are built-in to inhibit the growth of bacteria which may affect the plastic and wick in the humidifier. These properties do not extend to the water, humidified air, or users. Conduct routine cleaning and maintenance based upon use and individual conditions.

- No White Dust – The Hunter® Evaporative Humidifier produces no white dust that can settle on furniture or be inhaled.

NOTE: You may notice mineral deposits accumulating in the tank Tray. This is normal and does not affect performance. If you would like to clean these deposits away, please see “Cleaning and Storage” on page 6.

At A Glance

1

Know Your Humidifier

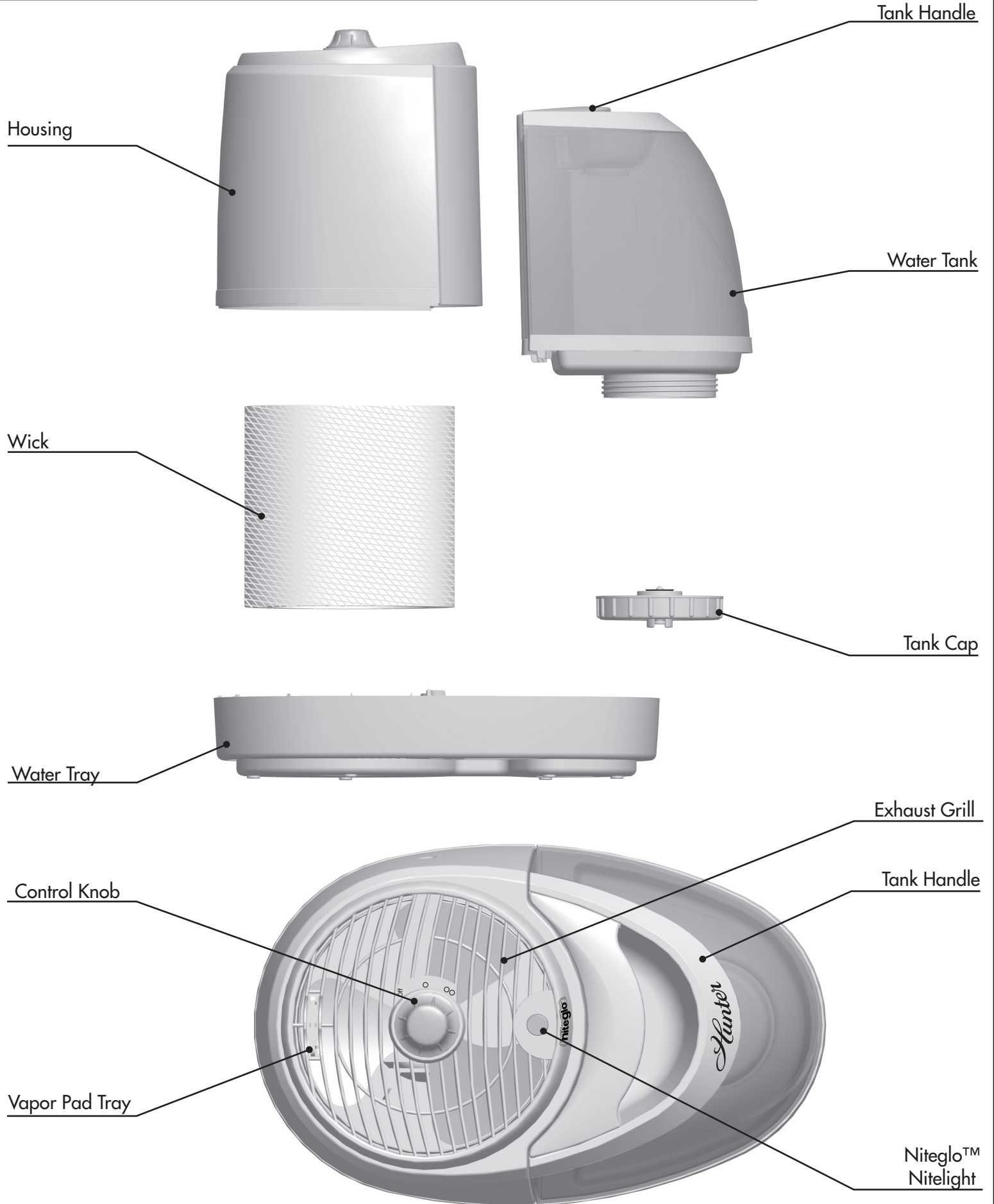

Initial Setup

1. Remove the Hunter® Evaporative Humidifier from its packaging.
2. Place the humidifier on a hard, flat, water resistant surface. Always place the humidifier at least six (6) inches away from walls and sources of heat.
3. Make sure the power/speed control is in the 'OFF' position.

NOTE: The power/speed control should always be off before unplugging the humidifier, moving the humidifier, or refilling the water tank.

4. Lift the housing to ensure the wick is properly seated, resting on the bottom of the water tray and not tilted or otherwise out of position. Figure 1. Place the housing back on the water tray.
5. Grasp the water tank by the tank handle and remove it from the water tray. Figure 2.
6. Turn the water tank upside-down and remove the tank cap by turning counter-clockwise. Figure 3.
7. Fill the water tank with clean, cool water and return the tank cap to its position. Tighten it by turning clockwise, and return the water tank to the water tray.
8. Plug the humidifier's power cord into a standard household power outlet.
9. Turn the power/speed control to your desired humidifier fan speed.

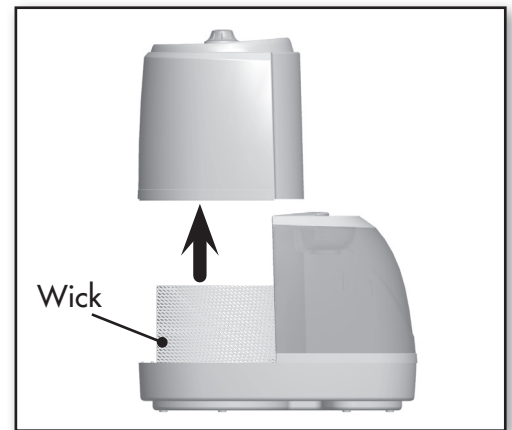

Figure 1.

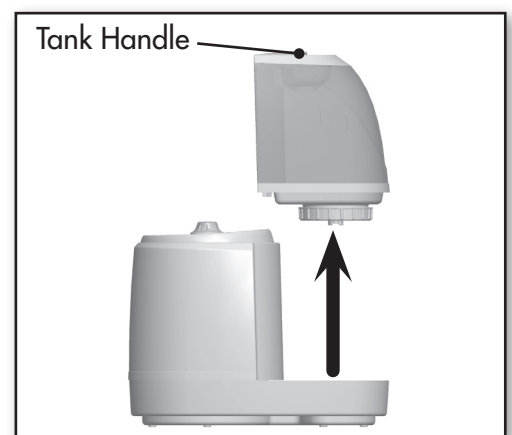

Figure 2.



Figure 3.

Operation

- Off** Turns the unit off.
- Low: Extends the time between refills by running the fan on low. Lowest noise setting recommended for nighttime use.
- High: Average refill rate and optimal for day use. Minimal noise level.

To turn on or off the Niteglo™ Nitelight, just press the Niteglo™ Button on the top of the unit.

See Figure 4. for a display of your controls.

If you choose to use vapor pads in your humidifier:

Remove 1 vapor pad from the packaging, and insert it lengthwise into the vapor pad tray on the top of the exhaust grill. Vapor pads will typically last for 24 hours before needing replacement.

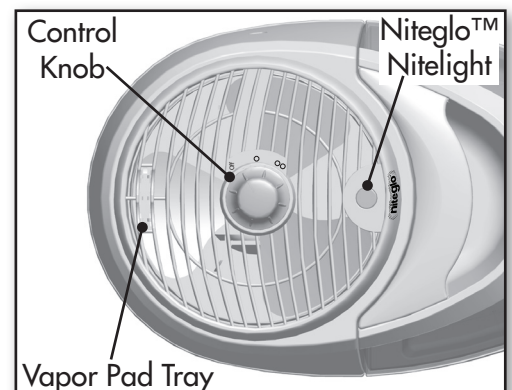
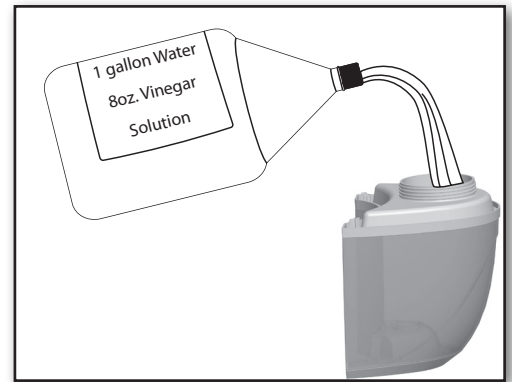
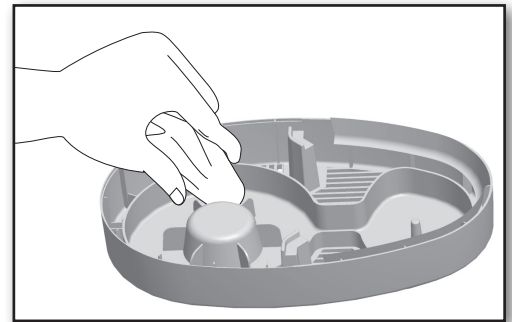

Figure 4.

Many regions have hard water with high concentrations of minerals. When water evaporates from the Hunter® evaporative humidifier, minerals may be left behind. These minerals can form a hard white scale which can be removed by following the cleaning instructions. The frequency of cleaning due to mineral build up can vary depending upon the quality of water you may have. Refer to "Know Your Humidifier" on page 4 for figure names.

1. Turn the humidifier off and unplug the unit.
2. Lift the main housing and remove the water dispersion tray and the wick. The motor is attached to the main housing. Do not place the motor near water. Do not use a wet towel on the motor or motor housing as electrical shock may occur.
3. Replace the humidifier's wick every 4 weeks or when it has turned brown.
4. Remove the water tank from the base and empty any water that is left in the tank. Soak the base in a mixture of one (1) gallon of water and eight (8) ounces of vinegar for 20 minutes. The base is dishwasher safe.
5. After soaking, wipe the base with a soft cloth or sponge to remove any mineral build up. Rinse with clean water several times. If you are planning on storing the humidifier, be sure the base is completely dry.
6. Fill the water tank with one (1) gallon of water and eight ounces of undiluted white vinegar. Figure 5. Replace the tank cap and shake the tank vigorously until all interior surfaces of the tank have been exposed to the water/vinegar mixture.
7. Empty the tank of the water/vinegar mixture. Rinse it several times with clean water and then replace the tank cap. If you are planning to store the humidifier, dry it inside and out, leaving the cap off to allow the tank to completely dry. Continue to clean the other parts of your humidifier.
8. Wipe the surfaces of the main housing with a soft cloth. Figure 6.
9. Once all the parts are clean, reassemble the humidifier, and follow "Initial Setup and Operation" on page 5 to continue use. If you are storing the humidifier, make sure all parts are completely dry before reassembling, and storing in a dry location.

**Figure 5.****Figure 6.**

NOTE: The humidifier's wick is made of paper and is NOT washable.

Over time, minerals in your water will build up in the humidifier's wick, degrading its ability to absorb water and reducing the humidifier's output. Therefore, you should replace the humidifier's wick every season, depending on the hardness of your water.

1. Turn the humidifier off and unplug the unit.
2. Lift the main housing, remove it from the base, and set it aside. Figure 7.
3. Grasp the humidifier wick, hold it over the base, and squeeze the water from it. Figure 8. This will keep water from dripping onto your floor. You may also want to wrap the wick in a towel to keep it from dripping while you transport it to disposal.
4. Replace the old wick with a new Hunter humidifier wick. New wicks are available at your local Hunter retailer or at www.hunterfan.com.
5. Ensure the wick is properly seated, resting on the bottom of the base and not tilted or otherwise out of position.
6. Return the main housing to its position on the base. Make certain the main housing is properly seated on the base.
7. Plug the humidifier's power cord into a standard household power outlet and turn the power/speed control to your desired setting.

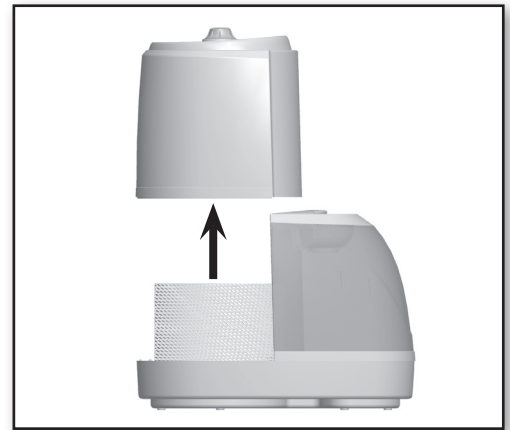

Figure 7.

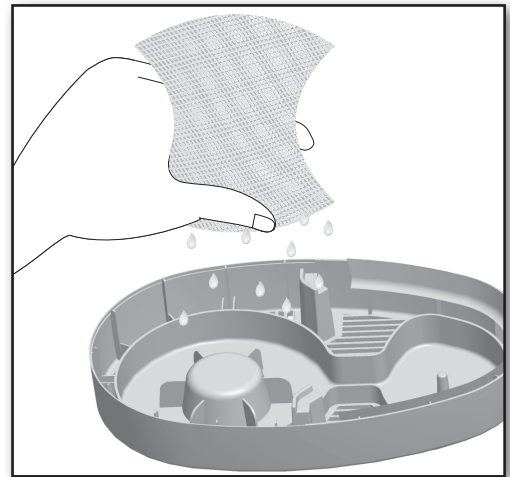

Figure 8.

Problem:

Excessive noise.

Solution:

1. Check the water tank to make sure it is properly seated on the base.
2. Check the water tank to make sure there are no bubbles when the water tank is full and running. If there are bubbles, turn the unit OFF until the bubbling stops. When the bubbling has stopped, set the unit to the desired speed.

**Problem:**

Humidifier not working.

Solution:

1. Make sure the power knob is not set to OFF and the unit is plugged into a working wall outlet.

Problem:

Mineral build-up on the water tank or water tray.

Solution:

1. Refer to the section "Cleaning and Storage" on page 6.





Problem:

Humidity output and water usage decreased.

Solution:

1. Check the power knob to make sure it is set to the desired speed.
2. Check the water tank to make sure there are no bubbles when the water tank is full and running. If there are bubbles, turn the unit OFF until the bubbling stops. When the bubbling has stopped, set the unit to the desired speed.
3. Clean any components that have mineral build-up. Refer to the section "Cleaning and Storage" on page 6.

Service Parts

Part #	Part Name	Part	Replace
89754-01-326	Water Tank		
G0841-01-679	Tank Assembly Cap		
31948	Wick		1 per month or as needed
99940-01-679	Water Tray		

Technical Support





If you need any assistance with setup, operation, or parts for your new Hunter Humidifier, please call us, our technical support staff is ready to help!

USA: 1-888-830-1326
Canada: 1-866-268-1936

Hours of operation are from 7:00 am to 7:00 pm Monday - Friday and 8:00 am to 5:00 pm on Saturday, Central Time. You may also contact us over the Internet at www.hunterfan.com or register your product at www.hunterfan.com/register and select your product under product registration.

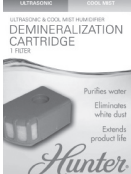

Treatments

	Model	Product	Evaporative	Ultrasonic	Vaporizer	Warm Mist
 <p>ULTRASONIC COOL MIST CLEANING CARTRIDGE PREVENT Microban Keeps your humidifier cleaner longer. Cartridges clean & protect humidifier against bacteria & mold. Simply drop in tank for fresh, clean mist. Keeps cleaning for 30 days.</p>	31955	Silver Ion Cartridge	✓	✓		
 <p>ULTRASONIC COOL MIST DEMINERALIZATION CARTRIDGE Purifies water. Eliminates white dust. Extends product life.</p>	31954	Demineralization Cartridge		✓		
 <p>VAPOR STEAM Liquid medication for Hunter's hot steam warm mist & vaporizers. Maintains steam effect to relieve coughs from colds.</p>	31961	Vapor Steam			✓	✓
 <p>VAPOR PADS Soothing menthol vapors. Up to 8 hours of comfort per pad.</p>	31956	Vapor Pads	✓	✓		
 <p>WATER TREATMENT Controls sedimentation. Removes mineral buildup. Eliminates white dust. Keeps tank clean. Prevents mold & bacteria.</p>	31960	Water Treatment Tablets	✓	✓		

Notes

The Hunter Fan Company, Inc. makes the following warranty to the original residential user or consumer purchaser of the evaporative humidifier:

If any part of the evaporative humidifier fails during the first 3 (three) years from the date of purchase due to a defect in material or workmanship, we will provide a replacement part free of charge.

If no replacement part can be provided, we will replace your humidifier.

IF THE ORIGINAL RESIDENTIAL USER OR CONSUMER PURCHASER CEASES TO OWN THE HUMIDIFIER, THIS WARRANTY AND ANY IMPLIED WARRANTY WHICH THEN REMAINS IN EFFECT, INCLUDING BUT NOT LIMITED TO ANY IMPLIED WARRANTY OF MERCHANTABILITY OR FITNESS FOR A PARTICULAR PURPOSE, ARE VOIDED. THIS WARRANTY IS IN LIEU OF ALL OTHER EXPRESS WARRANTIES. THE DURATION OF ANY IMPLIED WARRANTY, INCLUDING BUT NOT LIMITED TO ANY IMPLIED WARRANTY OF MERCHANTABILITY OR FITNESS FOR A PARTICULAR PURPOSE IS EXPRESSLY LIMITED TO THE PERIOD OF THE EXPRESS WARRANTY SET FORTH ABOVE.

This warranty is voided if your humidifier is not purchased and used in the USA or Canada.

This warranty excludes and does not cover defects, malfunctions, or failures of the humidifier which were caused by repairs by persons not authorized by us, use of parts, or accessories not authorized by us, mishandling, modifications, or damage to the humidifier while in your possession, or unreasonable use, including failure to provide reasonable and necessary maintenance. This warranty does not cover humidifiers used in commercial applications. There are no express or implied warranties as to commercial purchasers or users.

To obtain service, contact the nearest Hunter authorized service center or the Hunter Fan Company Service Department, 7130 Goodlett Farms Pkwy., Suite 400, Memphis, TN 38016, 1-888-830-1326. You will be responsible for insurance and freight or other transportation to our factory service center. We will return the Vaporizer freight prepaid to you. The humidifier should be properly packaged to avoid damage in transit since we will not be responsible for any such damage. Proof of purchase is required when requesting warranty service. The purchaser must present the sales receipt or other document that establishes proof of purchase.

IN NO EVENT SHALL HUNTER FAN COMPANY BE LIABLE FOR DIRECT, INDIRECT, SPECIAL, CONSEQUENTIAL OR INCIDENTAL DAMAGES IN EXCESS OF THE PURCHASE PRICE OF THE VAPORIZER. YOUR SOLE REMEDY WILL BE REPAIR OR REPLACEMENT AS PROVIDED ABOVE. SOME AMERICAN STATES AND CANADIAN PROVINCES DO NOT ALLOW:

- LIMITATIONS ON HOW LONG AN IMPLIED WARRANTY LASTS;
- THE EXCLUSION OR LIMITATION OF DIRECT, INDIRECT, SPECIAL, INCIDENTAL OR CONSEQUENTIAL DAMAGES;
- THE EXCLUSION OR INVALIDITY OF EXPRESS OR IMPLIED WARRANTIES IF THE USER CEASES TO OWN THE HUMIDIFIER;
- THE LIMITATION OF THE REMEDIES AND RECOURSES AVAILABLE TO THE PURCHASER; OR THE INVALIDITY OF AN EXPRESS WARRANTY WHEN A PRODUCT IDENTIFIED BY BRAND NAME IS NOT USED (UNLESS SPECIFIC CONDITIONS ARE FULFILLED);

SO THE ABOVE LIMITATIONS OR EXCLUSIONS MAY NOT APPLY TO YOU.

THIS WARRANTY GIVES YOU SPECIFIC LEGAL RIGHTS AND YOU MAY ALSO HAVE OTHER RIGHTS WHICH VARY FROM STATE TO STATE OR PROVINCE TO PROVINCE.



Free Manuals Download Website

<http://myh66.com>

<http://usermanuals.us>

<http://www.somanuals.com>

<http://www.4manuals.cc>

<http://www.manual-lib.com>

<http://www.404manual.com>

<http://www.luxmanual.com>

<http://aubethermostatmanual.com>

Golf course search by state

<http://golfingnear.com>

Email search by domain

<http://emailbydomain.com>

Auto manuals search

<http://auto.somanuals.com>

TV manuals search

<http://tv.somanuals.com>