

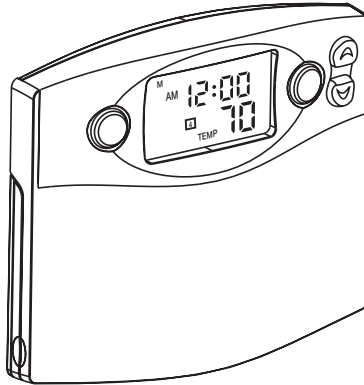

Set & Save

Programmable Thermostat



Owner's Manual

Model 44360

2

Introduction**2****CONGRATULATIONS!**

Your new Hunter electronic thermostat will provide years of reliable service. By saving energy, your thermostat will pay for itself during its first season of use. Thank you for buying a Hunter product!

Please read this manual for complete instructions on installing and operating your thermostat.

If you require further assistance, call Hunter Technical Support at 888-830-1326 from 8 a.m. to 5 p.m. Central Time.

Model Information:

Model Number **44360** _____

Serial Number _____

Date Purchased _____

Where Purchased _____

3

Table of Contents**3**

INTRODUCTION	Read This Before Installing Thermostat	5
	Features	7
INSTALLATION	What You Need	8
	Remove Old Thermostat	8
	Wire Labeling	9
	Mount Wallplate and Thermostat	11
	Connect Wires and Mount Thermostat Cover to Wall Plate	12
	Selector Switches	13
PROGRAMMING	Setting Time and Day	14
	Default Programs	16
	Personal Program Schedule	17
	Manual Programming	18
	Weekday / Weekend Programming	19
	7-Day Programming	21
	Reviewing Programs	22
Reviewing the Current Temperature Setting	23	
OPERATIONS	System Selector Switch	24
	Fan Switch	24
	Temporary Manual Override	25

(continued)

Table of Contents (continued)		4
OPERATIONS (continued)	Permanent Manual Override	26
	Vacation Override (Programmable Hold)	27
	Home Today	28
	Energy Monitor	30
	Filter Monitor	31
	Auto Recovery	32
	SPAN Setting Mode	34
	Backlighting	35
SAFETY FEATURES	Low Battery Warning	36
	Error Mode	37
	Auto Cut-Off	37
TROUBLESHOOTING	Problems & Solutions	38
	Technical Support	39
WIRING DIAGRAMS	Heat / Cool Systems	40
	Single-Stage Heat Pump Systems	41
	Heat Only / Cool Only Systems	41-42

Read This Before Installing Thermostat		5
IMPORTANT	<p>1 Read the entire installation section of this Owner's Manual thoroughly before you begin to install or operate your Hunter Thermostat.</p> <p>REMOVE THE MYLAR LABEL FROM THE LCD DISPLAY WINDOW.</p>	<p>air conditioning, or space heating units in use in the United States.</p> <p>This Hunter Thermostat will NOT control multi-stage heat pumps or 110/220 Volt systems.</p>
INSTALLATION	<p>2 All installation is normally performed at your thermostat.</p>	COMPRESSOR PROTECTION
ARMCHAIR PROGRAMMING	<p>3 You can program your thermostat before installation by inserting the batteries and following the instructions starting on page 16. This can be done while you relax in your favorite chair and is a very good way to familiarize yourself with all the functions of your Hunter Thermostat.</p>	<p>5 The thermostat provides a 3.5 minute delay after shutting off the heating or cooling system before it can be restarted. This feature will prevent damage to your compressor caused by rapid cycling. Note that this delay also applies to the heating system control. It does not prevent a rapid compressor re-start due to short power outages.</p>
OPERATION	<p>4 Your Thermostat is designed to operate with most gas, oil, electric or 2-wire hot water heating and air conditioning systems. It will also operate single-stage heat pumps that do not have auxiliary or emergency heat. These have 24-volt or millivolt control systems and represent most central heating,</p>	<p>TEMPERATURE RANGE</p> <p>6 Your thermostat can be programmed between 45°F and 95°F (4°C and 35°C). However, it will display room temperatures from 32°F to 99°F (0°C and 37°C). "HI" will be displayed if the temperature is higher than 99°F (37°C), and "LO" will be displayed if the temperature is lower than 32°F (0°C).</p> <p>This thermostat will automatically cut off in Heat mode if the temperature rises above 95°F (35°C), and automatically cut off in cool mode if the temperature drops below 45°F (7°C).</p>

Read This Before Installing Thermostat (continued)

POWER FAILURE

7 Whenever the main power is interrupted or fails, the battery power retains the programs and current time.

AUTO RECOVERY

8 Your thermostat is set from the factory to gradually recover the room temperature from an energy saving program to your comfort program. Therefore, the thermostat may turn your system on several minutes prior to your programmed time. This operation is normal, but can be turned off. Refer to the Selector Switches information on page 24.

BATTERY WARNING

9 Fresh alkaline batteries should provide over one year of service. However, when the batteries become drained, the Low Battery indicator will flash on the display. When this message occurs, install 2 new AA batteries. You have approximately 1 minute to

change the batteries and keep thermostat's clock and program settings. Once the batteries have become too low to ensure proper operation, your system will be turned Off, and the display will be cleared except for the Low Battery indicator flashing on the LCD display.



CAUTION: Once the Low Battery only display occurs, the thermostat is shut down, and your system will no longer operate. In this condition, there is no temperature control of your dwelling.

NOTE: The INDIGLO® night-light will not function when the thermostat is in low battery condition.

NOTE: If you plan to be away from the premises over 30 days, we recommend that you replace the old batteries with new alkaline batteries prior to leaving.

ENERGY STAR® Partner

As an ENERGY STAR® Partner, Hunter Fan Co. has determined that this programmable thermostat meets the ENERGY STAR® guidelines for energy efficiency.



Features

LCD Display: Shows time, day, temperature, program number, and other feature information as required.

Home Today: Overrides energy-saving program temperatures while you are home for the day.

Up and Down Keys: Keys for changing the Temperature setting. Also used for increasing and decreasing selections in the Time, Program, and Span functions.

Energy: Measures and displays heating and cooling system operating time for Today, Yesterday, This Week, Last Week, or Total. By monitoring your energy usage, you can program the thermostat to optimize energy savings.

System Switch: Selector switch for Heat, Cool, and Off

Fan Switch: Fan switch for Automatic or Continuous fan operation.

Reset: Press with a paper clip to reset the thermostat and return to power-up settings.

Program Day Key: Selects the day or days to review or change in the Program mode.

Battery Release Lever: Push to pop batteries loose.

Program Key: Used for entering and modifying Programs. Use with the Up and Down keys to set times and temperatures. Press when in Clock setting mode to select between 12 and 24 hour clock modes.

Filter Key: Resets Filter Change counter to zero.

Day / Time Key: Used for entering the Clock setting mode. Use with the Up and Down keys to set the time and day.

Hold / Return Key: Used for setting a permanent or vacation hold, and for returning to the normal display from Day & Time setting, Programming, or Span setting modes.

INSTALLATION

What You Need

This thermostat includes two #8 screws and two wall anchors for mounting. To install your thermostat, you should have the following tools and materials.

- Phillips and Slotted Screwdrivers
- Hammer
- Electric drill and 3/16" bit
- Two 1.5 V (AA) size alkaline batteries

Remove Old Thermostat

CAUTION: Do not remove any wiring from existing thermostat before reading the instructions carefully. WIRES MUST BE LABELED PRIOR TO REMOVAL.

- **IMPORTANT!** Turn off the power to the furnace at the main power panel or at the furnace.
- Remove existing thermostat cover. See Figure 1. Some thermostats will have screws or other locking devices that must first be removed. Once wall mounting plate is exposed, look for wires.

If wires are not visible, they may be connected to the back of the wallplate. Again, look for screws, tabs, etc. Some models have doors that open to expose wires and mounting screws. (See Figure 1).

TYPICAL HOME THERMOSTATS

Figure 1

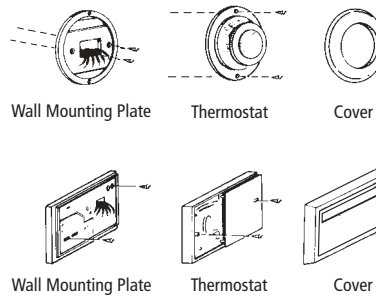

Wire Labeling

- Each wire coming from the wall to the existing thermostat is connected to a terminal point on that thermostat. Each of these terminal points is usually marked with a code letter as shown in Table A on the next page.
- Note that this thermostat has multiple function terminals that allow Single-Stage Heat Pump capability. Standard systems use: Rh, Rc, G, W. [Single-Stage Heat Pumps use: Rh, Y1, G, and O or B.] Table A below shows the multiple functions of the terminals. Use the terminals that match your system.
- The number of wires in your system can be as few as two (for heat only systems), as many as eight, or any number in between. If you follow the labeling procedures correctly, you do not have to be concerned about how many wires there are.
- There is often no terminal marking on the existing thermostat of two wire, heat only systems. Just connect either of the wires to the RH terminal, then connect the other wire to the W terminal to complete the circuit.

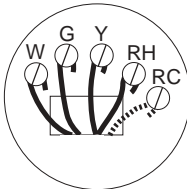

- **IMPORTANT! BEFORE DISCONNECTING ANY WIRES, APPLY THE SELF-ADHESIVE LABELS PROVIDED TO THE WIRE AS SHOWN IN TABLE A ON THE NEXT PAGE.** (For example, attach the label marked W to the wire that goes to the W or H terminal on your existing thermostat.) IGNORE THE COLOR OF THE WIRES since these do not always comply with the standard.
- After labeling wires, disconnect them from the existing thermostat terminals.
- Remove existing wallplate. To make sure wires do not fall back into wall opening, you may want to tape them to the wall.
- If hole in wall is larger than necessary for wires, seal this hole with insulating material so that no hot or cold air can enter the back of the thermostat from the wall. This air could cause a false thermostat reading.

(continued)

INSTALLATION
10

If the code letter on your existing thermostat is	then mark the wire with label shown	and connect to thermostat terminal shown
RH, R, VR or 4 24 Volt		
RC, VC 24 Volt Cool		
G or F Fan		
Y, C or M Air Conditioning Compressor - or - O Reversing Valve operating in Cool mode. (Single Stage Heat Pumps ONLY.)		
W or H Heating - or - B Reversing Valve operating in Heat mode. (Single Stage Heat Pumps ONLY.)		
Y1 Heat Pump compressor (Single Stage Heat Pumps ONLY.)		

Table A

NOTE: Do not connect a "Common" wire (sometimes labeled "C") to any terminal on this thermostat. Tape up the wire and do not use. This wire provides electricity to non-battery powered thermostats.

Mount Wallplate and Thermostat
11

- Remove the wallplate from your thermostat by pressing the release tab on the bottom of the thermostat. (See Figure 2.)
- Position wallplate on wall and pull existing wires through large opening. Then level for appearance. Mark holes for plastic anchors provided if your existing holes do not line up with those on the Hunter wallplate.
- Drill holes with 3/16" bit and gently tap anchors into the holes until flush with wall.
- Reposition wallplate to wall, pulling wires through large opening. Insert mounting screws provided into wall anchor and tighten. (See Figure 3.)

Figure 2

Figure 3

NOTE: 5-wire Systems
 If your thermostat has one wire marked R or RH (4-wire system), then leave the jumper wire between the RH and RC terminals on the wallplate.
 Otherwise, if you have separate RH and RC wires (5-wire system), then remove the jumper wire between the RH and RC terminals.

INSTALLATION

Connect Wires and Mount Thermostat Cover to Wall Plate

- Match and connect the labeled wires to the appropriate coded terminal screws on the wallplate. (See Figure 4, 5.) Ignore any wires which may be present, but which were not connected to the old thermostat.
- Refer to the Wiring Diagrams below to be sure your system is wired correctly.
- If your system is a single-stage heat pump and uses an O or B wire, you must move the System Selector switch inside the thermostat to the Heat Pump position. If you have a normal furnace or electric system, leave the switch in the Standard position. Refer to the System Selector section on the back for more information on this switch.
- Be sure to tighten the terminal screws securely, otherwise a loose wire could cause operational problems with your system or thermostat.
- Push excess wire back into the hole to prevent interference when installing the thermostat to the wallplate.
- Make sure the System Switch is set to OFF, and the Fan Switch is set to AUTO.
- Insert the bottom tab on the thermostat body into the slot at the bottom of the wallplate. Press the top of the thermostat body to snap it into the wallplate. Refer to Figure 6. (NOTE: *Do not force*

the thermostat onto the wallplate, as the terminal pins may be damaged. If it does not snap properly, the thermostat may not work.)

- Insert the two AA size alkaline batteries, observing the polarity marked inside the battery compartment.
- Switch on the main power at the panel or furnace.

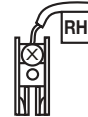

Figure 4

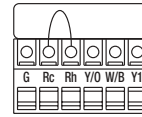

Figure 5

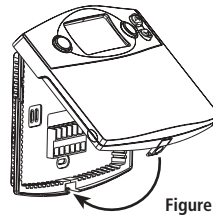

Figure 6

Selector Switches

In order for this Hunter thermostat to control your system, the system type must be specified by selector switches on the printed circuit board inside the thermostat.

NOTE: *When changing these features after installation, move the HEAT / COOL selector switch to OFF before removing the thermostat from the wall.*

System Selector Switches:

■ Heating system selector (HG – HE switch)

The factory position for this switch is in the "HG" position. Leave it in this position if you have a gas furnace or an oil burner.

If you have an electric furnace, test to see whether the Heat and Fan come on as expected.

If Fan operation is normal, leave the switch in the "HG" position.

If the Fan does not come on within a minute of the thermostat calling for Heat, change the switch position to "HE."

The system selector has no effect in the cooling mode.

NOTE: *"HG" position is for gas and most other systems. "HE" position is for certain electric systems having a fan relay.*

■ Furnace or Heat Pump selector (STD - HP switch)

The factory position for this switch is in the STD position. Leave it in this position if you have ANY system that uses gas, oil, electric, or hot water heating. If you have a single-stage Heat Pump (no auxiliary or emergency heat source), then slide the switch to the HP position.

■ Auto Recovery selector (DISABLE / ENABLE)

Your thermostat is set from the factory with the Auto Recovery Feature enabled, which complies with the EPA ENERGY STAR® Program. If you prefer to use normal recovery, slide the switch to the ALT position. Refer to page 32 for a complete discussion of the Auto Recovery feature.

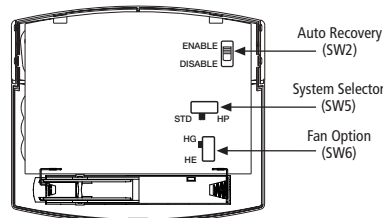



Figure 7

PROGRAMMING
14

Setting Time and Day

- The LCD will show this information when batteries are first installed, or after the Reset button is pressed. The temperature will update after a few seconds.
- During time and day setting mode, the temperature and program displays will go blank.
- Example: Set the Thermostat to the current time of 2:16 pm on Saturday. Refer to the Steps below.

STEP 1: day/time



- Press to enter time and day setting mode. The current hour and the AM / PM indicator will be flashing.
- Press to change the Hour up or down to the current hour. Note the AM / PM indicator, as the display will change at 12 AM and 12 PM.



STEP 2: day/time



- Press again to change from hour setting to minute setting. The current minute will be flashing.
- Press to change the Minute up or down to the current minute.



STEP 3: day/time



- Press again to change from minute setting to day setting. The current day will be flashing.
- Press to change the Day up or down to the current day.

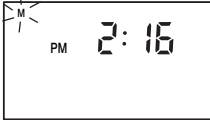

STEP 4: day/time

or

hold
/return

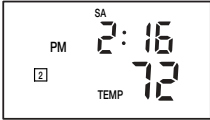

NOTE: You may press hold at any time during Day and Time setting to return to the normal display.

DAYLIGHT SAVING TIME

day/time



- Press and hold.
- Press to enter Daylight Saving Time.

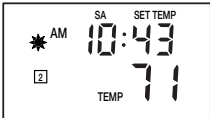

(continued)

PROGRAMMING

Setting Time and Day (continued)

12 HR. / 24 HR. TIME FORMAT

Your thermostat is set from the factory in normal 12 (AM / PM) time format. To change to 24 hour (military) time, press **(program)** at any time while the Hour,

Minute, or Day is flashing to toggle between the 12 hour and 24 hour formats. The AM / PM indicator will not be displayed in 24 hour mode. Both the current time and all programs will automatically change to the selected format.

Default Programs

Studies conducted by the Department of Energy estimate that setting your thermostat back 10°F (6°C) for two 8-hour periods during winter can reduce your fuel bill by as much as 33%. By setting your thermostat up

5°F (3°C) for two 8-hour periods during summer you can reduce your fuel bill up to 25%.
Your Hunter thermostat is pre-programmed to meet the ENERGY STAR® guidelines for energy efficiency.

- The thermostat is pre-programmed for all 7 days of the week as shown below.

Program Number	Time	Temperature in F° (C°)	
		Heat	Cool
1	6:00am	68°F (20°C)	78°F (26°C)
2	8:00am	60°F (16°C)	85°F (29°C)
3	4:00pm	68°F (20°C)	78°F (26°C)
4	10:00pm	60°F (16°C)	82°F (28°C)

- Refer to Manual Programming on page 18 for instructions on entering or changing the programs.

Personal Program Schedule

Before programming or changing programs, use this Personal Program Schedule to determine which times and temperature settings will best satisfy both your comfort and energy saving requirements.

Use a pencil so you can revise your records each time you change your temperature settings.

Heating

Day	Prog. 1	Prog. 2	Prog. 3	Prog. 4
Mon.	Time Temp	Time Temp	Time Temp	Time Temp
Tues.	Time Temp	Time Temp	Time Temp	Time Temp
Wed.	Time Temp	Time Temp	Time Temp	Time Temp
Thurs.	Time Temp	Time Temp	Time Temp	Time Temp
Fri.	Time Temp	Time Temp	Time Temp	Time Temp
Sat.	Time Temp	Time Temp	Time Temp	Time Temp
Sun.	Time Temp	Time Temp	Time Temp	Time Temp

Cooling

Day	Prog. 1	Prog. 2	Prog. 3	Prog. 4
Mon.	Time Temp	Time Temp	Time Temp	Time Temp
Tues.	Time Temp	Time Temp	Time Temp	Time Temp
Wed.	Time Temp	Time Temp	Time Temp	Time Temp
Thurs.	Time Temp	Time Temp	Time Temp	Time Temp
Fri.	Time Temp	Time Temp	Time Temp	Time Temp
Sat.	Time Temp	Time Temp	Time Temp	Time Temp
Sun.	Time Temp	Time Temp	Time Temp	Time Temp

PROGRAMMING

18

Manual Programming

- Your thermostat can be programmed for weekdays and weekends, or have unique programs for all 7 days. Use Weekday/Weekend Programming below or 7-day Programming on page 21 to enter or revise programs to match your Personal Program Schedule.
- Familiarize yourself with Manual Programming, so that you can easily modify your programs as your comfort needs change. The example below demonstrates how to program your thermostat.

- NOTE:**
- 1) *The program time can be set in 10 minute increments, and remains the same for both Heat and Cool programs.*
 - 2) *The program temperature can be set in increments of 1°F (1°C).*
 - 3) *After 15 seconds without a key press, the thermostat will return to normal display mode.*
 - 4) *When setting the program time, note the AM / PM indicator.*
 - 5) *With the Auto Recovery feature enabled, you do not need to set your comfort program times early. Auto Recovery will determine how early to turn your system on, so that the room is comfortable at the program time.*

Weekday/Weekend Programming

- system** ■ Slide System Selector Switch to HEAT or COOL to program the corresponding system.
- off heat cool

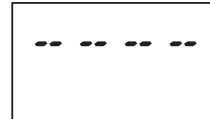

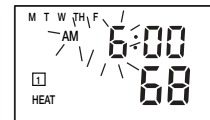

NOTE: *If the system selector is in the OFF position, no programming is permitted. The LCD display will show only dashes when the program key is pressed.*

- STEP 1:**  ■ Press to enter program mode. HEAT or COOL will be displayed on the LCD.



- STEP 2:**  ■ The Program hour and AM or PM indicator are flashing. Press to change the hour.

- STEP 3:**  ■ Press again to change to the minute position. The current minute will be flashing.
-  ■ Press to change the minute.

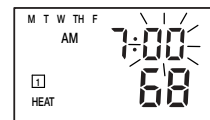

(continued)

PROGRAMMING

Weekday/Weekend Programming (continued)

- STEP 4:**  ■ Press again to change to the program temperature. The current temperature will be flashing.



- Press to change the temperature.

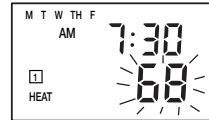

- STEP 5:**  ■ Press again to move to the next program number.
■ Repeat steps 3 - 5 to change the remaining weekday programs.

- STEP 6:**  ■ Press to change to weekend programs.
■ Repeat steps 3 - 5 to change the weekend programs.



- Press to exit Program mode, or wait 15 seconds to exit automatically.

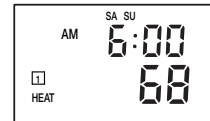

7-Day Programming



- Slide System Selector Switch to HEAT or COOL to program the corresponding system.

- STEP 1**  ■ Press to enter program mode, display shows week-day programs.



- Press 2 times to reach the Monday program.

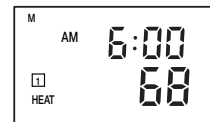

- Step 2** ■ Use , , and  keys to set the 4 programs for Monday.

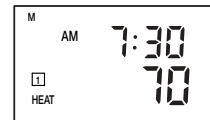

- Step 3**  ■ Press to change to the next day's programs.
■ Repeat Step 2 to complete the selected day's programs.
■ Continue repeating Steps 2 and 3 to program all 7 days of the week.

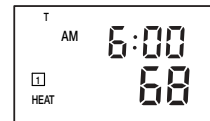

- Step 4**  ■ When finished press to return to normal mode.
■ After 15 seconds, the thermostat will return to normal mode automatically.

- Step 5** ■ Change the System Selector Switch to the other system, and repeat Steps 1 through 4 above.

PROGRAMMING

Reviewing Programs

You may want to review the programs to confirm that the settings are compatible with your lifestyle.

- Weekday Programs** (program) ■ Press to display M – F programs.
 ■ Press repeatedly to cycle through the 4 programs.

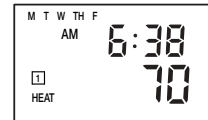

- Weekend Programs** (prog day) ■ Press to display the Sa – Su programs.
 (program) ■ Press repeatedly to cycle through the 4 programs.

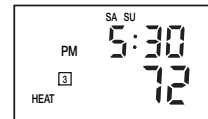

- Daily Programs** (program) ■ Press to display M – F programs.
NOTE: Time and Temperature display will be blank when at least one weekday program is different.



- (prog day) ■ Press to change to Sa – Su. Again, if the display is blank, one of the weekend programs is different.

- Daily Programs (cont.)** (prog day) ■ Press again to change to Monday's program.
 ■ Continue pressing to cycle through each day.
 (program) ■ Press repeatedly to cycle through the 4 programs.
 (hold /return) ■ Press to return to normal mode.
 ■ After 15 seconds, the thermostat will return to normal mode automatically.

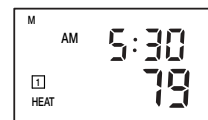

NOTE: Programs take affect as soon as the thermostat returns to normal mode.

If you are armchair programming the thermostat, slide the system selector to the OFF position before mounting the thermostat to the wallplate.

Reviewing the Current Temperature Setting

- Current time and temperature.

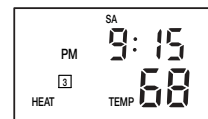

- Press for 1 second or less.
 ■ Set Temperature is shown above current room temperature.
 ■ If held for over 1 second, Temporary Manual Override mode is entered. Refer to the next page.

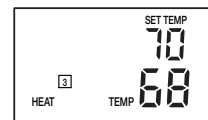

OPERATION

12° 71° 70°

24

System Selector Switch

The System Selector switch on the front of the thermostat determines the operating mode of the thermostat. You may select COOL, OFF, HEAT.

NOTE: *Anytime you install or remove the thermostat from the wallplate, slide the System Selector to the OFF position to prevent the possibility of a rapid system On-Off.*

system

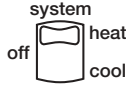

Fan Switch

The Fan switch should normally be located in the AUTO position. The Fan will be turned on along with normal operation of your system. In a normal gas or oil furnace, the Fan will be turned on by your furnace after its warm-up delay. For electric heat, air conditioning, and heat pump operation, the Fan will turn on with the system.



To run the Fan on continuously, slide the Fan switch to the ON position.

fan





Temporary Manual Override
25

To temporarily change the current set temperature without affecting your program:

 or

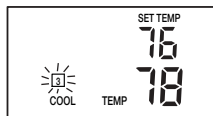
■ Press and hold for about 1 second to enter Manual Override mode. When display flashes, you can release the key.



 or

■ Press again to change to your desired Set Temperature. Hold the key for 2 seconds to fast-advance the Set Temperature.

hold
 /return

■ Press to return to normal mode, or wait 5 seconds for it to return automatically.

■ The current program number will flash to signify the Temporary Override.

■ At the next program change time, the Temporary Override is cancelled, and the next program temperature becomes the setpoint temperature.

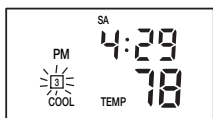

To end the Temporary Manual Override:

hold
 /return

■ Press and wait for HOLD to display on the LCD.

■ Press again. This will return the set temperature to the current program set temperature.

OPERATION

12° 71° 70°

26

Permanent Manual Override

To hold your Manual Override for vacation or just an extended period of time:

hold
/return

- Press to make the current program temperature the HOLD temperature. HOLD will be displayed on the LCD, and the Program number will disappear.
- Follow the Temporary Manual Override instructions above to change the Permanent Manual Override temperature.

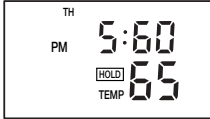

- You can confirm the held set temperature by pressing for less than 1 second.



To end the Permanent Manual Override:

hold
/return

- Press again. The thermostat will return to the current program, and the HOLD display will be canceled.

Vacation Override (Programmable Hold)

This thermostat can hold a fixed temperature for a selected number of days (up to 30). After the selected number of days, the thermostat will return to normal program operation. This feature allows you to return home to your normal comfort setpoint temperatures.

hold
/return

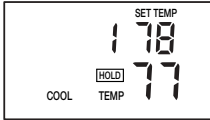

- Press and hold for 2 seconds. Display will change to show a 1 day hold.

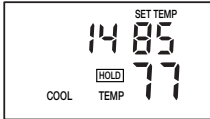

day/time

- Press to select the number of days to set the vacation hold temperature. In this example, 14 is used.





or

- Press to set the desired temperature.

hold
/return

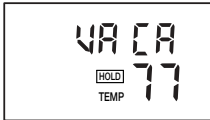
- Press to return to normal mode, or wait 5 seconds for it to return automatically.
- HOLD will be shown on the LCD, and "VACA" will alternate with the time.



Download from Wwww.Somanuals.com. All Manuals Search And Download.

OPERATION

12° 71° 10°

Home Today

This Hunter patented feature allows you to quickly and temporarily override your energy saving program setting on days when you are normally away from home with one key press.



- Press to enter the Home Today override. The highest program temperature for today will be selected from your programs in Heat mode and become the set temperature. (In Cool mode, Home Today will select the lowest program temperature for today to be the set temperature.)

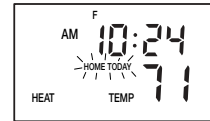

- The display will flash "HOME TODAY" and the program number will disappear.
- When pressed during the first or second program of the day, Home Today will automatically return to program control at the start of the fourth program of the day. If Home Today is pressed after the start of the third program time of the day, the thermostat will remain in Home Today mode until the first program of the next day.



- If Home Today is already active, you may similarly extend it to the first program of the next day by pressing the key again after the start time of the third program.

- If the system is changed between Heat and Cool modes during the "Home Today" override period, the setpoint temperature will be automatically updated. It will automatically change from the highest heat program setpoint to the lowest cool program setpoint, or from the lowest cool program setpoint to the highest heat program setpoint.



- Press to exit Home Today mode before the schedule ending time. "HOME TODAY" is no longer displayed on the LCD screen, and the thermostat returns to the current program.

- You can manually change the setpoint temperature while in Home Today mode. Refer to the Temporary Manual Override instructions on page 24. Manually changing the set temperature while in Home Today mode will not affect the Home Today ending time. *However, the set temperature will not change automatically with a manual or Automatic change between heating and cooling.*



- You may also press the HOME TODAY key while in Temporary Manual Override. The operation is the same as the previous point above.

OPERATION

12° 71° 70°

Energy Monitor

The Energy monitor feature measures and stores the amount of time the heating and air conditioning system operates. Usage can be displayed for Today (since 12am), Yesterday, This Week (since Monday), Last Week (last Monday through Sunday), and Total (up to

999 Hrs. 59 Min.). By monitoring your energy usage, you see how much the set-back periods are saving and you can test program adjustment to save even more. Use table on page 17.



- To review energy usage, press to cycle through Today, Yesterday, This Week, Last Week, and Total. Press again to return to normal mode, or wait 15 seconds for the display to return to normal mode. You can also return to normal mode at any time by pressing RETURN.



- For example: This LCD display shows Today's usage to be 10 Hours, 26 minutes.



- Press and hold for 3 seconds to reset the Energy Monitor's counters. The display will blink, and all counters will be cleared to zero.

NOTE: Clearing the Energy Monitor counter will also clear the Filter Monitor counter, as Filter usage and Total Energy usage are the same. Also, clearing the Filter Monitor counter will clear ALL Energy Monitor counters as well.

Filter Monitor

Your thermostat also keeps a record of the number of hours your filter has been in use. To maximize your system's performance and energy efficiency, change or clean your filter regularly.

- When the total system run time for heat and cool reaches 400 hours, FILTER will flash on the LCD display to remind you to clean or change your system's filter. FILTER will continue to flash until the counter is set back to zero.

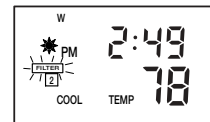

filter

- Press to review total filter usage. The display will blink FILTER, then show the Filter Monitor counter. After 15 seconds, the display will return to normal mode, or you can hit RETURN to exit immediately. The Filter Monitor will display up to 999 hours and 59 minutes of usage.

In this example, the counter is at 410 Hours, 26 minutes.

- To reset the Filter Monitor counter, depress FILTER for 3 seconds. The display will blink, and the counter will be reset to zero.



NOTE: Clearing the Filter Monitor counter will also clear ALL Energy Monitor counters, as Filter usage and Total Energy usage are the same. Also, clearing the Energy Monitor counters will clear the Filter Monitor counter as well.

OPERATION

12° 71° 70°

Auto Recovery

Hunter's Auto Recovery feature meets the ENERGY STAR® guidelines for energy efficiency by allowing the heating or cooling system to recover gradually from an energy-saving setpoint temperature to a comfort setpoint temperature.

Auto Recovery calculates how early to turn your system back On, so that the room temperature is already comfortable by the start of the comfort temperature program period. Auto Recovery works in both Heat and Cool modes.

For example, in Heat mode, you could have the following programs:

Program #4 (Overnight)	Program #1 (Morning)
Set Temp = 60°F	Set Temp = 68°F
Time = 10pm	Time = 6am

The room temperature fell to 60°F overnight. Rather than having the thermostat turning on at 6am, Auto Recovery would note the temperature difference between 60°F and 68°F and turn the Heat on approximately 30 minutes early. Therefore, the room temperature at 6am would be about 68°F instead of 60°F.

- When the thermostat is in Auto Recovery mode, the display will alternate RECO with time, and the program indicator will flash.

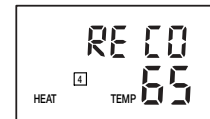
**Details of Auto Recovery Operation:**

- Auto Recovery can be disabled by sliding the Recovery switch on the circuit board to the DISABLE position. Refer to page 13.
- Auto Recovery will not operate if Permanent hold, Temporary hold or Home Today is in operation.
- Auto Recovery can be canceled manually if HOLD/RETURN is pressed during the recovery process. If a recovery process is canceled manually then the recovery process will not start again until the next program period starts (an exception is that if time or program is changed then the thermostat will check Auto Recovery conditions immediately).
- Auto Recovery will be canceled and change to Home Today mode if HOME TODAY is pressed during the recovery process.
- Auto Recovery will be canceled and change to Temporary Manual Override mode if the setpoint is adjusted during the recovery process.
- If the system is changed between heat and cool then the thermostat will recalculate Auto Recovery again. Setpoint temperature will be changed to the opposite system's comfort temperature if the recovery entry criteria are still met. Otherwise, the recovery process will be canceled and return to program control mode.

12° 71° 70°

SPAN Setting Mode

Your thermostat is set at the factory to cycle at 1°F (0.5°C) above and below the set temperature. (Span = 2) This setting has been designed to provide a comfortable room temperature under most

all conditions. However, if you find your system cycling too fast or too slow, then the Span can be adjusted to modify the cycle time.



- Press and hold BOTH for three seconds. The display will flash, and SPAN will be displayed on the LCD.



- Press to raise the Span to 3. This setting INCREASES the cycle time by allowing your system to run LONGER.



- Press to lower the Span to 1. This setting DECREASES the cycle time by causing your system to run SHORTER.

The Span settings remain the same for both HEAT and COOL.

The Span can be changed at any time, and is independent of program times or temperatures.

When batteries are installed in the thermostat, or the Reset key is pressed, the Span is reset back to setting 2.

Backlighting (INDIGLO® night-light)

Your thermostat has an electroluminescent lamp that backlights the display for easy viewing in the dark.

When any key is pressed or the System Switch is changed, the display is illuminated.

The display will remain illuminated for 5 seconds after the last key is pressed. This allows the light to stay on if you need to operate several keys.

NOTE: If the thermostat is in Low Battery warning condition, the backlight will not operate. Replace with 2 new alkaline batteries to restore the Backlight function.

SAFETY FEATURES

Low Battery Warning

- Your thermostat has a two-stage low battery warning system. When the batteries are first detected to be weak, the first stage low battery warning is indicated by battery symbol flashing on the LCD display. At your earliest convenience, you need to replace the batteries with 2 new AA alkaline batteries.

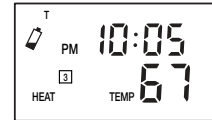

- When the batteries become too weak for normal operation, the thermostat enters the second stage low battery warning which shuts down the thermostat. In this condition, "BATT" flashes alone on the display, and the thermostat will turn your system Off. Your system will remain shut-off until the batteries are replaced.



NOTE: *The thermostat will still keep the current time and your programs in memory until new batteries are installed. After confirming that new batteries have been inserted, the thermostat will return to normal operation.*

Error Mode

- If the thermostat is unable to control your system due to an unexpected battery problem, the thermostat will enter Error Mode. In this condition, the thermostat flashes "Err" on the LCD display, and shuts off your system. To correct this problem, replace the batteries with 2 new AA alkaline batteries, even if you have recently replaced them. Next, use a paper clip to press the RESET button next to the keypad. You will need to reprogram your thermostat and confirm normal operation.
- If Error Mode returns, please call Hunter Technical support at 1-888-830-1326 for further information.

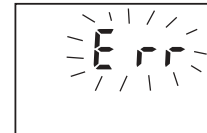

Auto Cut Off

Your thermostat will automatically cut-off in Heat mode if the room temperature rises above 95°F (35°C). It will cut-off in Cool mode if the room temperature drops below 40°F (4°C).

NOTE: *If your system has malfunctioned and no longer responds to thermostat controls, the Auto Cut-Off will have no effect.*

TROUBLESHOOTING**38**

Problem	Solution
Scrambled or Double Display (numbers over numbers)	1. Remove clear mylar sticker.
No Display	1. Check battery connections and batteries. 2. Press RESET button with a small pin and hold in for two seconds.
Entire Display Dims	1. Replace Batteries.
Program Does Not Change at your Desired Setting	1. Check that the time is set properly to "AM" or "PM". 2. Check that the thermostat is not in "HOLD" or "Home Today" modes. 3. Check for the correct day setting.
Auto / Fan Does Not turn On	1. Move HG/HE selector to opposite position
Heating or Cooling Does Not Go On or Off	1. Check that the system selector switch is in the correct position ("HEAT," "COOL"). 2. There may be as much as a 4 minute delay before the Heat or Cool system turns On - wait and check. (Compressor protection delay.) 3. Check your circuit breakers and switches to ensure there is power to the system. 4. Replace batteries. 5. Make sure your furnace blower door is closed properly. 6. If your system only uses 4-wires, be sure the jumper wire is installed between the RC and RH terminals. 7. Check the position of the Furnace or Heat Pump selector switch: STD - HP.

Problem (cont.)	Solution (cont.)	39
Erratic Display	1. Press the RESET button once with a small pin and hold for two seconds. The thermostat will need to be re-programmed.	
If unit continues to operate in the Off position	1. Replace unit.	
Thermostat permanently reads "HI," "LO," or "ERR-" after pressing reset button	1. Replace unit.	

If you experience any other problems, call 888-830-1326 from 8 AM to 5 PM Central Time for technical assistance.

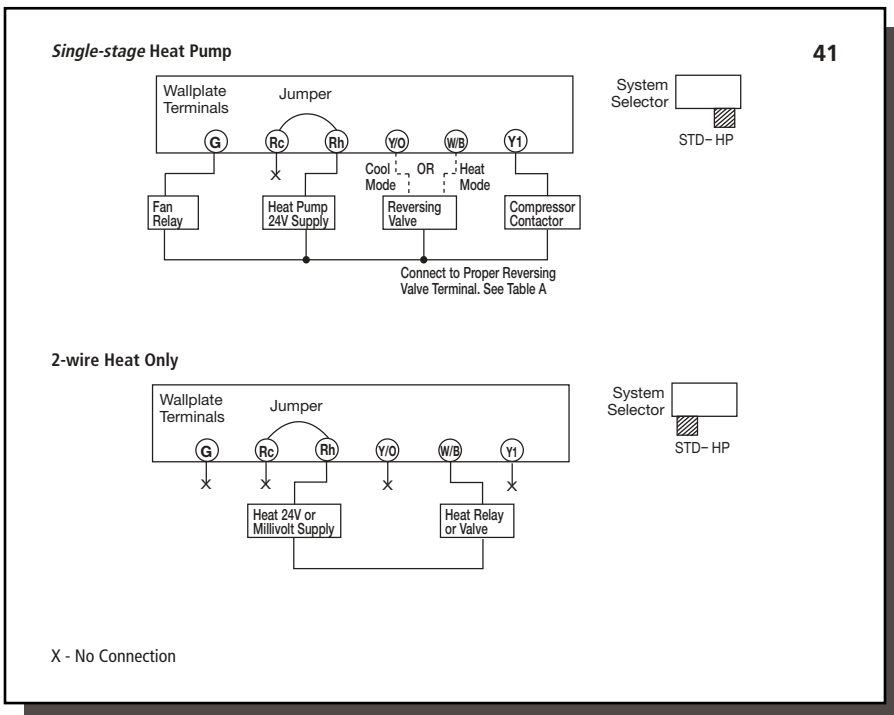
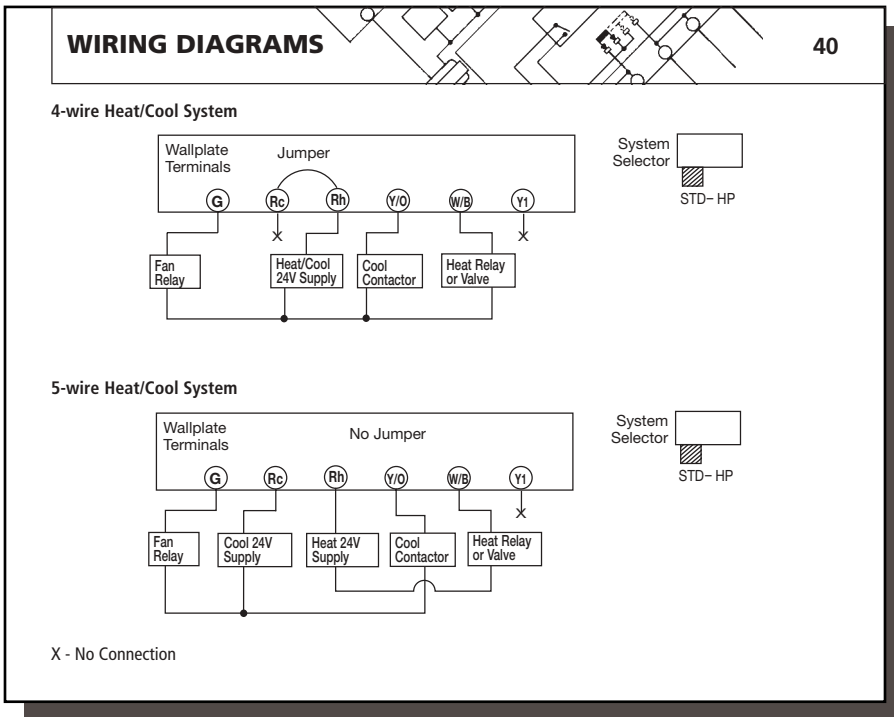

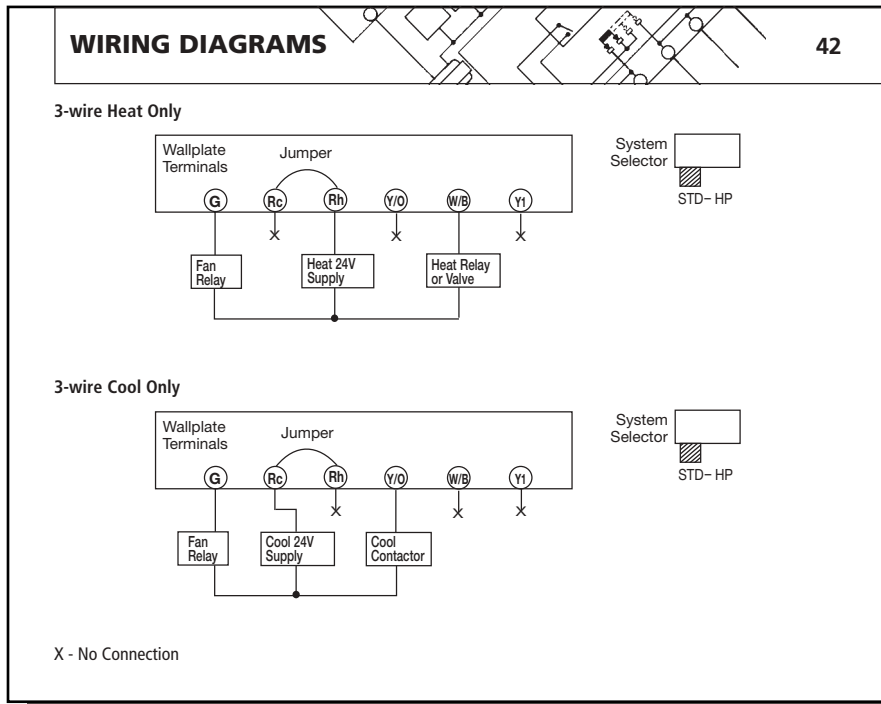

Ask Your Local Retailer for Other Quality Products from Hunter

Fans

Air Purifiers

Humidifiers

**To locate our nearest Hunter Dealer, call 1-800-4HUNTER,
or visit The Hunter Fan Company website: www.hunterfan.com**



© 2003, Hunter Fan Company Form No. 41644-01, 8/03



Hunter Fan Company
2500 FRISCO AVENUE
MEMPHIS, TN 38114

Free Manuals Download Website

<http://myh66.com>

<http://usermanuals.us>

<http://www.somanuals.com>

<http://www.4manuals.cc>

<http://www.manual-lib.com>

<http://www.404manual.com>

<http://www.luxmanual.com>

<http://aubethermostatmanual.com>

Golf course search by state

<http://golfingnear.com>

Email search by domain

<http://emailbydomain.com>

Auto manuals search

<http://auto.somanuals.com>

TV manuals search

<http://tv.somanuals.com>