

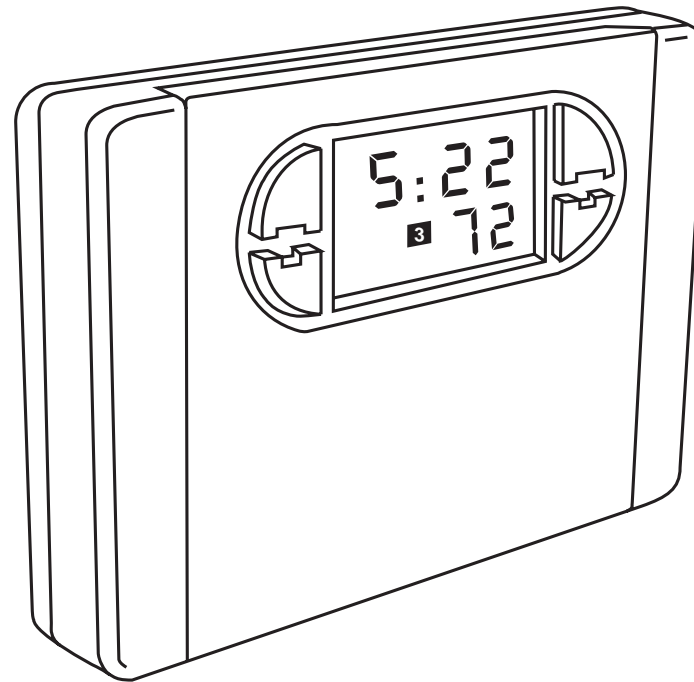

AUTO SAVER 550



Owner's Manual

Model 47550

Ask Your Local Retailer for Other Quality Products from Hunter

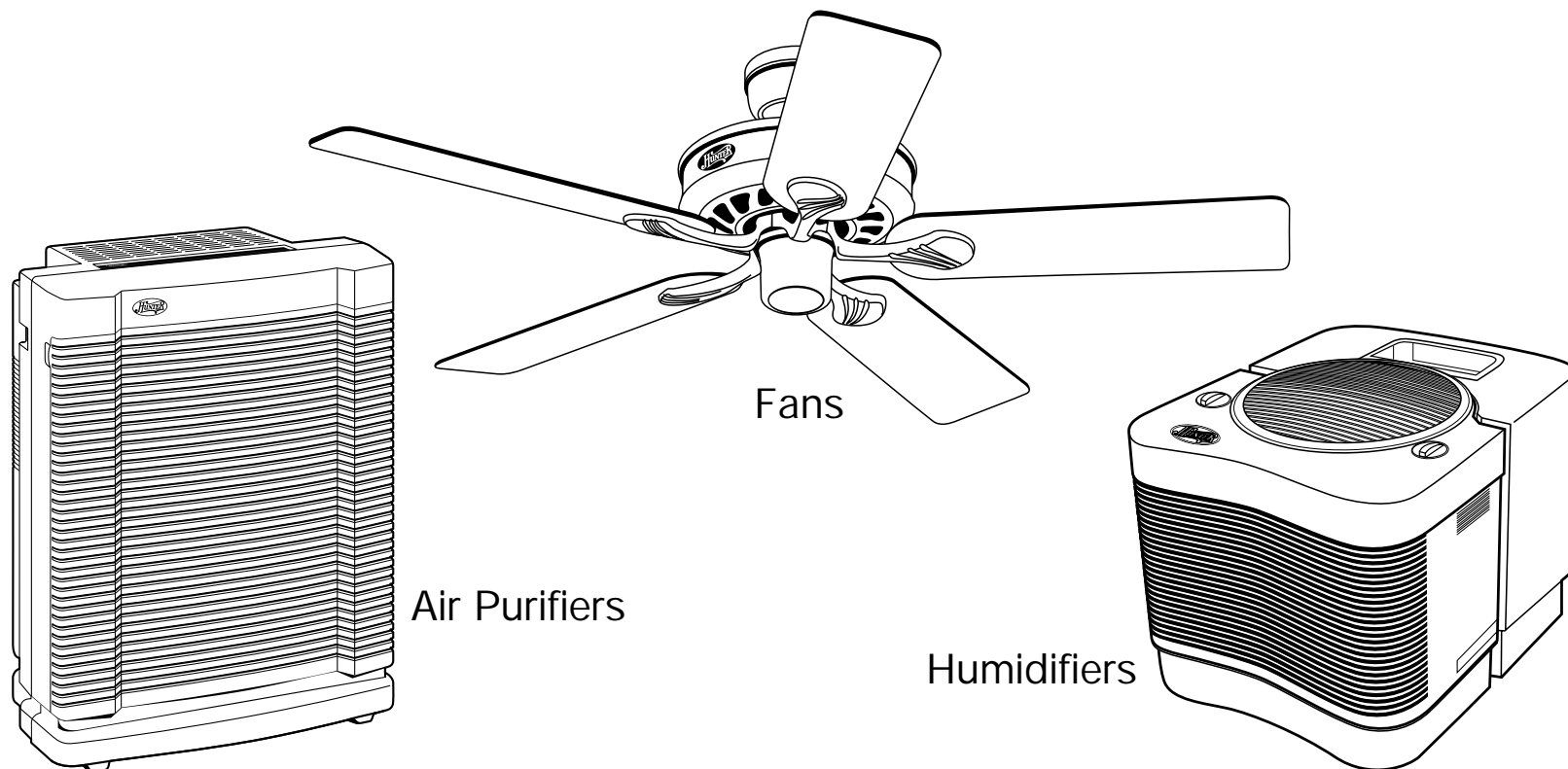

To locate your nearest Hunter Dealer, call 1-800-4HUNTER,
or visit The Hunter Fan Company website: www.hunterfan.com

Introduction

CONGRATULATIONS!

Your new Hunter electronic thermostat will provide years of reliable service. By saving energy, your thermostat will pay for itself during its first season of use. Thank you for buying a Hunter product!

Please read this manual for complete instructions on installing and operating your thermostat.

If you require further assistance, call Hunter Technical Support at 901-745-9222 from 8 a.m. to 5 p.m. Central Time.

Model Information:

Model Number **47550**

Serial Number _____

Date Purchased _____

Where Purchased _____

Table of Contents 4-5

INTRODUCTION	Read This Before Installing Thermostat	6
	Features	8
INSTALLATION	What You Need	10
	Remove Old Thermostat	10
	Wire Labeling	11
	Mount Wallplate and Thermostat	12
	Selector Switches	14
PROGRAMMING	Setting Time and Day	16
	Auto Programming	17
	Personal Program Schedule	18
	Manual Programming	19
	Weekday / Weekend Programming	19
	7-Day Programming	21
	Reviewing Programs	22
	Reviewing the Current Temperature Setting	23
OPERATIONS	System Selector Switch	24
	Fan Switch	24

(continued)

Table of Contents (continued)

OPERATIONS (continued)	Temporary Manual Override	24
	Permanent Manual (Vacation) Override	25
	Auto Season Changeover	26
	Home Today	26
	Energy Monitor	28
	Filter Monitor	29
	Auto Recovery	30
	Keyboard Lock	31
	Backlighting	31
SAFETY FEATURES	Low Battery Warning	32
	Error Mode	33
	Auto Cut-Off	33
TROUBLESHOOTING	Problems & Solutions	34
	Technical Support	35
WIRING DIAGRAMS	Heat / Cool Systems	36
	Single-Stage Heat Pump Systems	37
	Heat Only / Cool Only Systems	38

Read This Before Installing Thermostat

6-7

IMPORTANT

1 Read the entire installation section of this Owner's Manual thoroughly before you begin to install or operate your Hunter Thermostat.

REMOVE THE MYLAR LABEL FROM THE LCD DISPLAY WINDOW.

INSTALLATION

2 All installation is normally performed at your thermostat.

ARMCHAIR PROGRAMMING

3 You can program your thermostat before installation by inserting the batteries and following the instructions starting on page 16. This can be done while you relax in your favorite chair and is a very good way to familiarize yourself with all the functions of your Hunter Thermostat.

Note: *At initial power-up this thermostat is programmed at 68°F (20°C) for Heat and 78°F (26°C) for Cool. Any change to the set temperature will be treated as a Permanent Manual Override. See page 25 for more information. Press Auto Program to load the built-in energy saving programs.*

OPERATION

4 Your Thermostat is designed to operate with most gas, oil, electric or 2-wire hot water heating and air conditioning systems. It will also operate single-stage heat pumps that do not have auxiliary or emergency heat. These have 24-volt or millivolt control systems and

represent most central heating, air conditioning, or space heating units in use in the United States.

This Hunter Thermostat will NOT control multi-stage heat pumps or 110/220 Volt systems.

COMPRESSOR PROTECTION

5 The thermostat provides a 3.5 minute delay after shutting off the heating or cooling system before it can be restarted. This feature will prevent damage to your compressor caused by rapid cycling. Note that this delay also applies to the heating system control. It does not provide a delay when there are power outages.

TEMPERATURE RANGE

6 Your thermostat can be programmed between 40°F and 95°F (4°C and 35°C). However, it will display room temperatures from 32°F to 99°F (0°C and 37°C). "HI" will be displayed if the temperature is higher than 99°F (37°C), and "LO" will be displayed if the temperature is lower than 32°F (0°C).

NOTE: *The thermostat will automatically change to the Cool mode if the thermostat measures a temperature over 99°F (37°C). "Hi" will be displayed on the LCD, and the Cooling system will turn On. Similarly, the thermostat will automatically change to the Heat mode if the temperature is below 32°F (0°C). "LO" will be displayed on the LCD, and the Heating system will turn On.*

Read This Before Installing Thermostat (continued)

POWER FAILURE

7 Whenever the main power is interrupted or fails, the battery power retains the programs and current time.

AUTO RECOVERY

8 Your thermostat is set from the factory to gradually recover the room temperature from an energy saving program to your comfort program. Therefore, the thermostat may turn your system on several minutes prior to your programmed time. This operation is normal, but can be turned off. Refer to the Selector Switches information on pages 14-15.

BATTERY WARNING

9 Fresh alkaline batteries should provide over one year of service. However, when the batteries become drained, "BATT" will alternate on the display with the current time. When this message occurs, install 2 new AA batteries. You

have approximately 1 minute to change the batteries and keep thermostat's clock and program settings. Once the batteries have become too low to ensure proper operation, your system will be turned Off, and the display will be cleared except for "BATT" flashing on the LCD display.



CAUTION: *Once the "BATT" only display occurs, the thermostat is shut down, and your system will no longer operate. In this condition, there is no temperature control of your dwelling.*

NOTE: *The INDIGLO® night-light will not function when the thermostat is in low battery condition.*

NOTE: *If you plan to be away from the premises over 30 days, we recommend that you replace the old batteries with new alkaline batteries prior to leaving.*

Light Bar: Activates INDIGLO® night-light to allow display viewing in the dark.

HOME TODAY: Overrides energy-saving program temperatures while you are at home for the day.

Alpha-numeric display shows time, day, temperature, program number, and other feature information as required.

ENERGY: Measures and displays heating and cooling system operating time for Today, Yesterday, This Week, Last Week, or Total. By monitoring your energy usage, you can program the thermostat to optimize energy savings.

Temperature Keys: Keys for raising or lowering temperature settings.

Battery Door: Front-access battery door allows easy battery changes.

System Switch: System selector switch for Cool, Off, Heat or Auto.

Soft-touch programming keypad, see details below.

Fan Switch: Fan switch for Automatic or Continuous On fan operation.

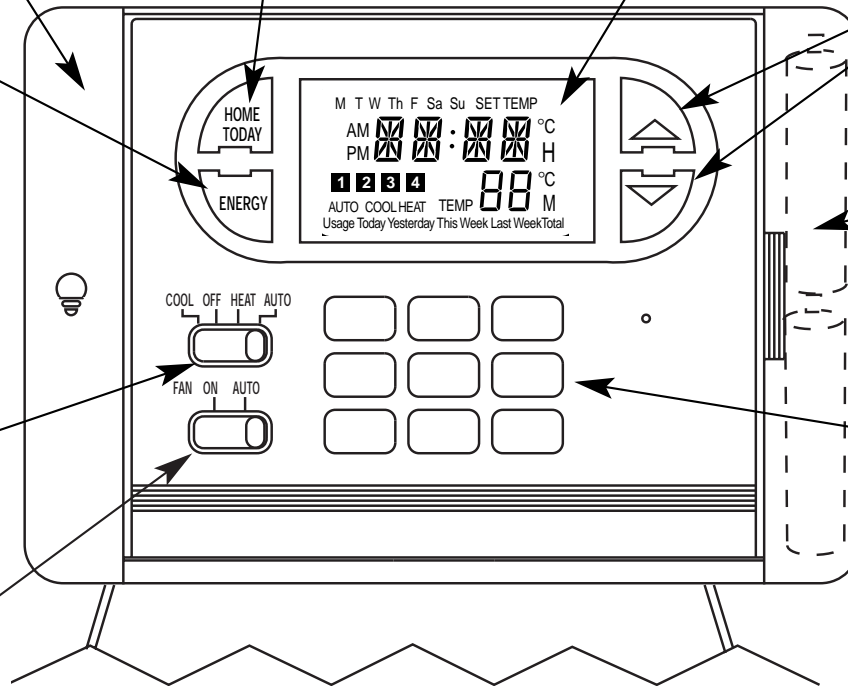

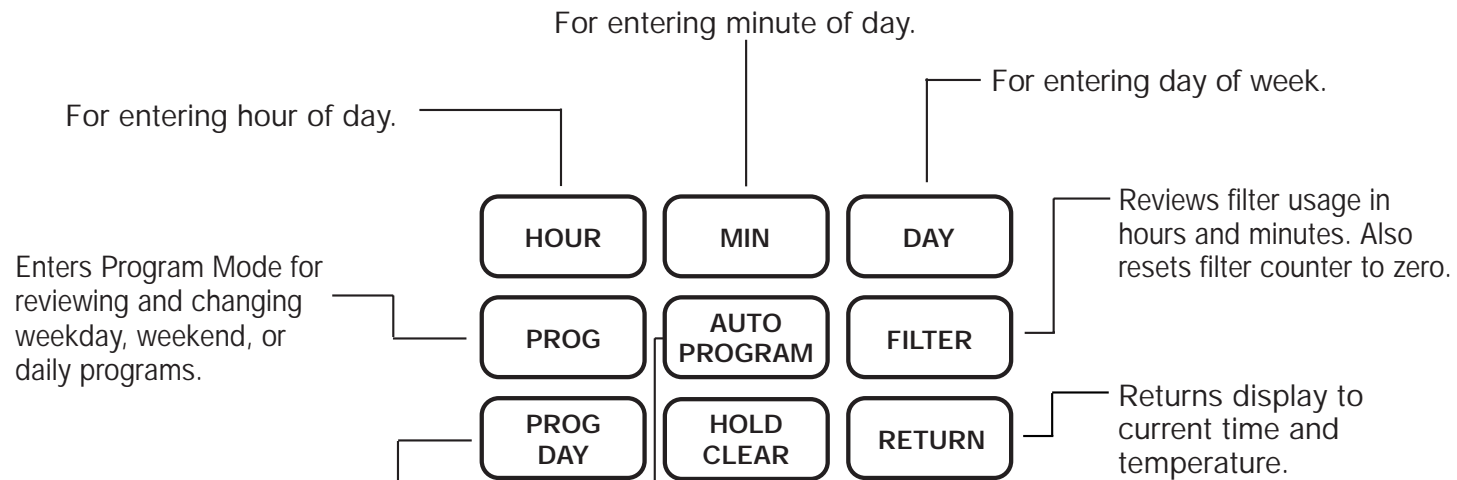

As an ENERGY STAR[®] Partner, Hunter Fan Company has determined that this programmable thermostat meets the ENERGY STAR[®] guidelines for energy efficiency.

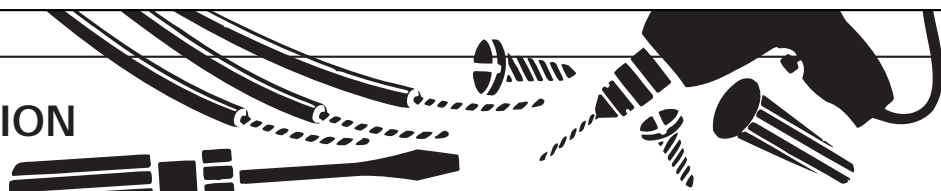

What You Need

This thermostat includes two #8 slotted screws and two wall anchors for mounting. To install your thermostat, you should have the following tools and materials.

- Slotted Screwdriver(s)
- Phillips Screwdriver
- Hammer
- Electric drill and 3/16" bit
- Two 1.5 V (AA) size alkaline batteries

Remove Old Thermostat

CAUTION: Do not remove any wiring from existing thermostat before reading the instructions carefully. WIRES MUST BE LABELED PRIOR TO REMOVAL.

- **IMPORTANT!** Turn off the power to the furnace at the main power panel or at the furnace.
 - Remove existing thermostat cover. See Figure 1. Some thermostats will have screws or other locking devices that must first be removed. Once wall mounting plate is exposed, look for wires.
- If wires are not visible, they may be connected to the back of the wallplate. Again, look for screws, tabs, etc. Some models have doors that open to expose wires and mounting screws. (See Figure 1).

TYPICAL HOME THERMOSTATS

Figure 1

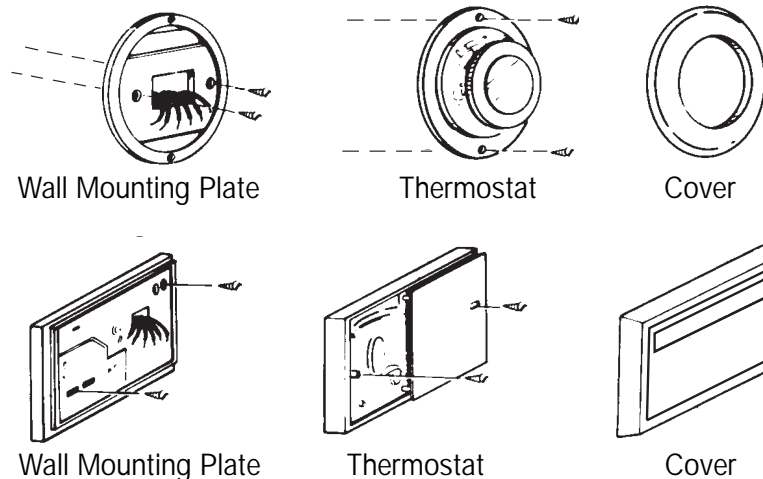

Wire Labeling

- Each wire coming from the wall to the existing thermostat is connected to a terminal point on that thermostat. Each of these terminal points is usually marked with a code letter as shown in Table A on this page.
- The number of wires in your system can be as few as two (for heat only systems), as many as eight, or any number in between. If you follow the labeling procedures correctly, you do not have to be concerned about how many wires there are.
- There is often no terminal marking on the existing thermostat of two wire, heat only systems. Just connect either of the wires to the RH terminal, then connect the other wire to the W terminal to complete the circuit.
- **IMPORTANT! BEFORE DISCONNECTING ANY WIRES, APPLY THE SELF-ADHESIVE LABELS PROVIDED TO THE WIRE AS SHOWN IN TABLE A ON THIS PAGE.** (For example, attach the label marked W to the wire which goes to the W or H terminal on your existing thermostat.) **IGNORE THE COLOR OF THE WIRES** since these do not always comply with the standard.
- After labeling wires, disconnect them from the existing thermostat terminals.
- Remove existing wallplate. To make sure wires do not fall back into wall opening, you may want to tape them to the wall.
- If hole in wall is larger than necessary for wires, seal this hole so that no hot or cold air can enter the back of the thermostat from the wall. This air could cause a false thermostat reading.

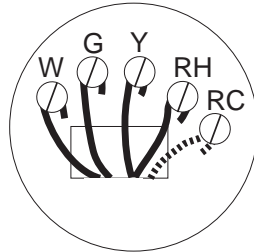

If the code letter on your existing thermostat is then mark the wire with label shown and connect to thermostat terminal shown

RH, R, VR or 4 24 Volt		
RC, VC 24 Volt Cool		
G or F Fan		
Y, Y1, C or M (See Note) Air Conditioning Compressor		
W or H Heating Not for heat pumps		
O, B, or R Reversing Valve (Single-stage Heat Pumps only)		

Table A

NOTE: Do not connect a "Common" wire (sometimes labeled "C") to any terminal on this thermostat. Tape up the wire and do not use. This wire provides electricity to non-battery powered thermostats.

Mount Wallplate and Thermostat

- Remove the wallplate from your thermostat by pressing the release tab on the bottom of the thermostat. (See Figure 2.)
- Position wallplate on wall and pull existing wires through large opening. Then level for appearance. Mark holes for plastic anchors provided if your existing holes do not line up with those on the Hunter wallplate.
- Drill holes with 3/16" bit and gently tap anchors into the holes until flush with wall.
- Reposition wallplate to wall, pulling wires through large opening. Insert mounting screws provided into wall anchor and tighten. (See Figure 3.)

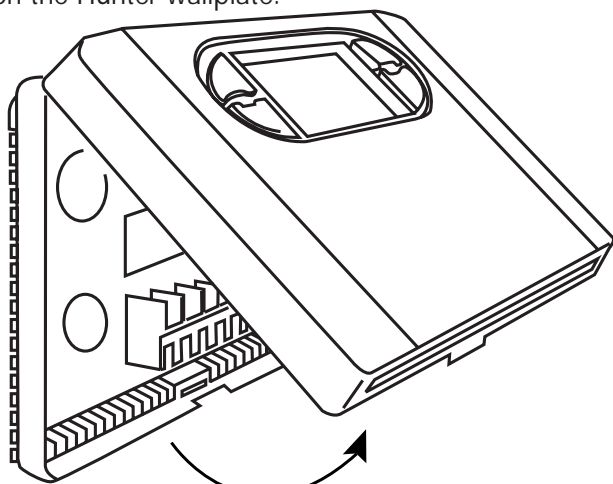

Figure 2

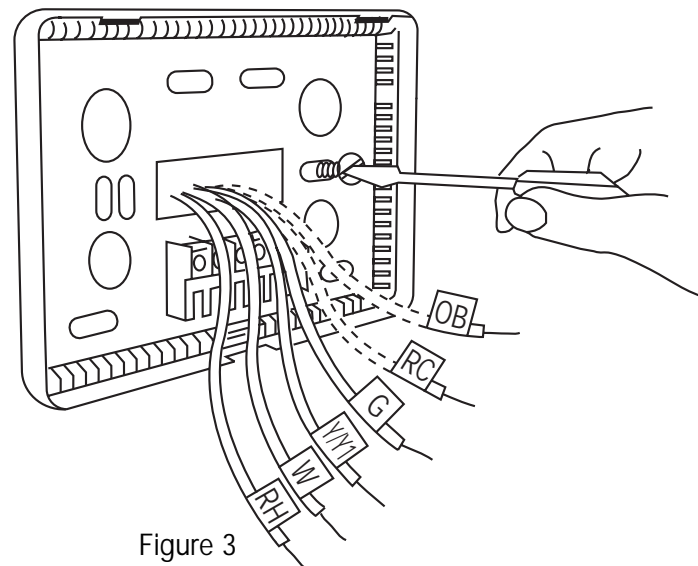

Figure 3

NOTE: 5-wire Systems

If your thermostat has one wire marked R or RH (4-wire system), then leave the jumper wire between the RH and RC terminals on the wallplate.
 Otherwise, if you have separate RH and RC wires (5-wire system), then remove the jumper wire between the RH and RC terminals.

Connect Wires and Mount Thermostat Cover to Wall Plate

- Match and connect the labeled wires to the appropriate coded terminal screws on the mounting plate. (See Figure 4, 5.) Ignore any wires which may be present, but which were not connected to the old thermostat.
- Be sure to tighten the terminal screws securely, otherwise a loose wire could cause operational problems with your system or thermostat.
- Push excess wire back into hole to prevent interference with mounting of the thermostat cover.
- Make sure the System Switch is set to OFF, and the FAN-AUTO Switch is in AUTO.
- If your system has an O or B wire, you must move the Heat Pump selector switch to the appropriate position. Refer to the next page for more information.
- Insert the bottom tab on the thermostat body into the slot at the bottom of the wallplate. Press top of the thermostat body to snap it into the wallplate. **NOTE: Do not force the thermostat onto the wallplate, as the terminal pins may be damaged. If it does not snap properly, the thermostat may not work.**
- Insert the two AA size alkaline batteries, observing the polarity marked on the unit.
- Switch on the main power at the panel or furnace.

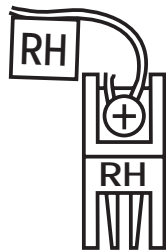

FIGURE 4

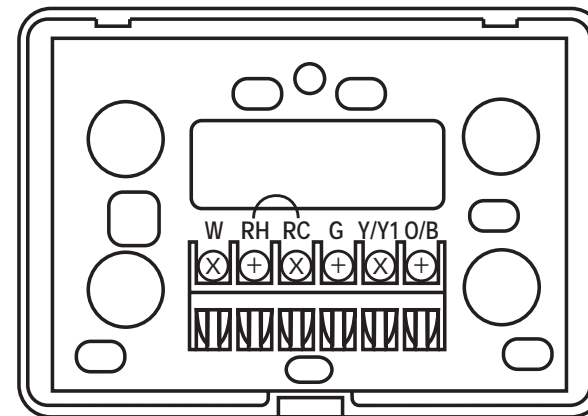

FIGURE 5

Selector Switches

In order for this Hunter thermostat to control your system, the system type must be specified by selector switches on the printed circuit board inside the thermostat. There are also other selector switches that allow you to customize the features to suit your needs.

NOTE: *When changing these features after installation, move the HEAT / COOL selector switch to OFF before removing the thermostat from the wall.*

System Selector Switches:

■ Heating system selector (HG – HE switch)

The factory position for this switch is in the "HG" position. Leave it in this position if you have a gas furnace or an oil burner.

If you have an electric furnace, test to see whether the Heat and Fan come on as expected.

If Fan operation is normal, leave the switch in the "HG" position.

If the Fan does not come on within a minute of the thermostat calling for Heat, change the switch position to "HE."

The system selector has no effect in the cooling mode.

NOTE: *"HG" position is for gas and most other systems. "HE" position is for certain electric systems having a fan relay.*

■ Furnace or Heat Pump selector (NORMAL – O – B switch)

The factory position for this switch is in the NORMAL position. Leave it in this position if you have ANY system that uses gas, oil, electric, or hot water heating.

If you have a single-stage Heat Pump (no auxiliary or emergency heat source), then slide the switch to the position that matches your Reversing Valve type. If your heat pump system has a "B" wire, slide the switch to "B" for your reversing valve that activates in HEAT mode. If your heat pump system has an "O" wire, slide the switch to "O" for your reversing valve that activates in COOL mode.

F°/C° selector (SW5) 12 Hr./24 Hr. selector (SW6) Recovery selector (SW8) Span selector (SW7)

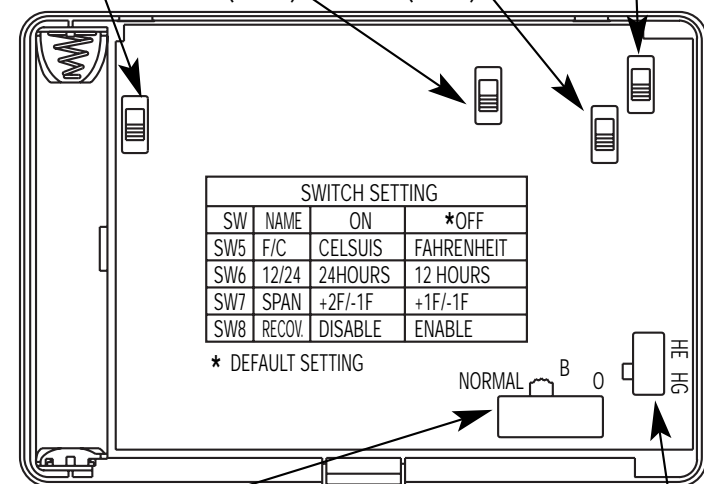

Normal – O – B – switch

HG – HE switch

Feature Selector Switches:

■ **F° / C° selector (Fahrenheit / Centigrade) – Switch 5**

Your thermostat is set for F° mode from the factory. In order to change to C° mode, slide the switch to C° and press the reset button on front of the thermostat with a paper clip.

NOTE: Unless the reset button is pressed, the thermostat will not change temperature mode.

■ **12 Hr. / 24 Hr. selector – Switch 6**

Your thermostat is set for normal 12 hour (AM / PM) time format. To change to 24 hour (military) time, slide the switch to the 24 position. This change may be made without resetting the thermostat, and will automatically change the current time display and all program times in memory.

■ **Span selector - Switch 7**

Your thermostat is set to cycle at 1° F (0.5°C) above and below the set temperature. If you require slower temperature cycles in

Heat mode, you can select +2°F / - 1°F by sliding the switch to the ALT position. This may be necessary if your heating system cycles too rapidly.

■ **Auto Recovery selector - Switch 8**

Your thermostat is set from the factory with the Auto Recovery Feature enabled, which complies with the EPA ENERGY STAR® Program. If you prefer to use normal recovery, slide the switch to the ALT position.

Refer to page 30 for a complete discussion of the Auto Recovery feature.

Feature Selector Summary:

Table B below summarizes the Feature Switches discussed above. A similar table is printed directly on the circuit board for your quick reference.

Switch	Function	Switch Setting	
		Alternate	Standard
SW 5	F° / C°	Celsius	Fahrenheit
SW 6	12 Hr. / 24 Hr.	24 Hour	12 Hour
SW 7	Span	+2°F / -1°F	+1°F / -1°F
SW 8	Auto Recovery	Disable	Enable

Table B

Setting Time and Day

Remove the mylar label covering the LCD display window before operating thermostat.

- Initial display after power-up or reset. The LCD will show the information when batteries are first installed, or after the Reset button is pressed. The temperature will update after a few seconds.

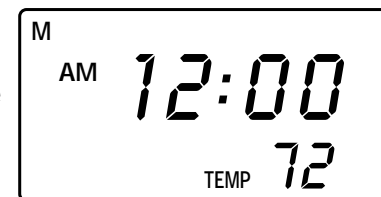

- During time and day setting mode, the temperature and program displays will go blank.

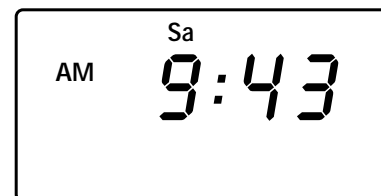

EXAMPLE:
Set the thermostat to the current time of 9:43 a.m. on Saturday. Refer to Figure at right.

HOUR

- Press and hold to rapid advance to the current hour. Tap to advance one hour at a time. Note the AM / PM indicator, as the display will cycle through 24 hours.

MIN

- Press and hold to rapid advance to the current minute. Tap to advance one minute at a time.

DAY

- Tap to advance one day at a time.

RETURN

- When finished, press to return to the Normal time and temperature display or wait 15 seconds for it to return to Normal mode automatically.

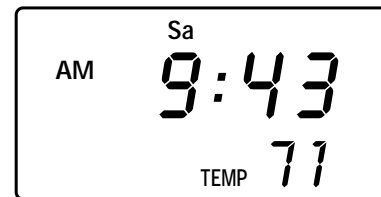

Auto Programming

Studies conducted by the Department of Energy estimate that setting your thermostat back 10°F (6°C) for two 8-hour periods during winter can reduce your fuel bill by as much as 33%. By setting your thermostat up 5°F (3°C) for two 8-hour periods during summer you can reduce your fuel bill up to 25%.

Your thermostat is capable of holding up to 4 separate programs for each day of the week. You can program all weekdays, Monday

to Friday, to the same 4 programs as shown in the table, or each weekday can have a different set of 4 programs. Similarly weekend programs, Saturday and Sunday, can be the same 4 programs or each weekend day can have a different set of 4 programs.

Your Hunter thermostat is pre-programmed to meet the ENERGY STAR® guidelines for energy efficiency. Note that it is easier to modify these programs than to program the thermostat manually.



■ Press once. During Auto Programming, the display will change as shown.

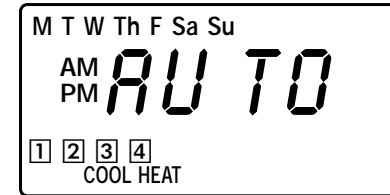

■ The thermostat will be programmed for all 7 days of the week as shown below.

Program Number	Time	Temperature in F° (C°)	
		Heat	Cool
1	6:00am	68°F (20°C)	78°F (26°C)
2	8:00am	60°F (16°C)	85°F (29°C)
3	4:00pm	68°F (20°C)	78°F (26°C)
4	10:00pm	60°F (16°C)	82°F (28°C)

■ Refer to Manual Programming on page 19 for instructions on entering or changing the programs.

Personal Program Schedule

Before programming or changing programs, use this Personal Program Schedule to determine which times and temperature settings will best satisfy both your comfort and energy saving requirements.

Use a pencil so you can revise your records each time you change your temperature settings.

Heating

Day	Program 1	Program 2	Program 3	Program 4
Mon.	Time	Time	Time	Time
	Temp	Temp	Temp	Temp
Tues.	Time	Time	Time	Time
	Temp	Temp	Temp	Temp
Wed.	Time	Time	Time	Time
	Temp	Temp	Temp	Temp
Thurs.	Time	Time	Time	Time
	Temp	Temp	Temp	Temp
Fri.	Time	Time	Time	Time
	Temp	Temp	Temp	Temp
Sat.	Time	Time	Time	Time
	Temp	Temp	Temp	Temp
Sun.	Time	Time	Time	Time
	Temp	Temp	Temp	Temp

Cooling

Program 1	Program 2	Program 3	Program 4
Time	Time	Time	Time
Temp	Temp	Temp	Temp
Time	Time	Time	Time
Temp	Temp	Temp	Temp
Time	Time	Time	Time
Temp	Temp	Temp	Temp
Time	Time	Time	Time
Temp	Temp	Temp	Temp
Time	Time	Time	Time
Temp	Temp	Temp	Temp
Time	Time	Time	Time
Temp	Temp	Temp	Temp

Manual Programming

■ Your thermostat can be programmed for weekdays and weekends, or have unique programs for all 7 days. Use Weekday/Weekend Programming below or 7-day Programming on page 21 to enter or revise programs to match your Personal Program Schedule. The same steps are used when entering programs for the first time, or revising programs entered during Auto Programming.

■ When batteries are first installed, the thermostat has all 4 programs set for 68°F (20°C) in Heat mode and 78°F (26°C) in Cool mode.

NOTE: There are no energy saving time or temperature settings until the thermostat is Auto Programmed or Manually Programmed.

■ Familiarize yourself with Manual Programming, so that you can easily modify your programs as your comfort needs change. The example below demonstrates the Manual Programming method.

- NOTE:**
- 1) The program time can be set in 10 minute increments, and remains the same for both Heat and Cool programs.
 - 2) The program temperature can be set in increments of 1°F (1°C).
 - 3) The Heat setpoint can not be set higher than the Cool setpoint, and the Cool setpoint can not be set lower than the Heat setpoint.
 - 4) If the system selector is in AUTO mode, the current operating mode will be used for programming.
 - 5) After 15 seconds without a key press, the thermostat will return to normal display mode.
 - 6) When setting the program time, note the AM / PM indicator.
 - 7) With the Auto Recovery feature enabled, you do not need to set your comfort program times early. Auto Recovery will determine how early to turn your system on, so that the room is comfortable at the program time.

Weekday/Weekend Programming

Step 1

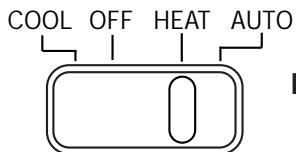

■ Slide System Selector Switch to HEAT or COOL to program the corresponding system.

NOTE: If the system selector is in the OFF position, no programming is permitted. The LCD display will show only dashes when the program key is pressed.

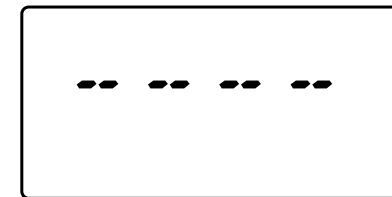

Weekday/Weekend Programming (cont.)

Step 2

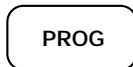

- Press PROG key to enter program mode, display shows weekday programs.
- Display for HEAT mode shown.

Step 3

Use and to change the setpoint time.

Use and to change the setpoint temperature.

Step 4

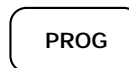

- Press to move to programs 2, 3 and 4.
- Repeat Step 3 to complete the weekday programs.

Step 5



- Press to change to weekend programs.
- Repeat Steps 3 and 4 to complete the weekend programs.

Step 6



- If you desire only weekend and weekday programs, press to return to normal mode.
- After 15 seconds, the thermostat will return to normal mode automatically.

Step 7

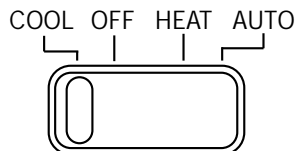

- Change the System Selector Switch to the other system, and repeat Steps 2 through 6 above.

Step 2

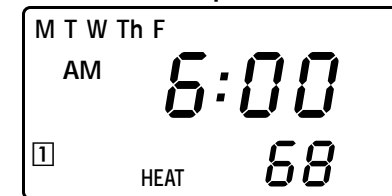

Step 3

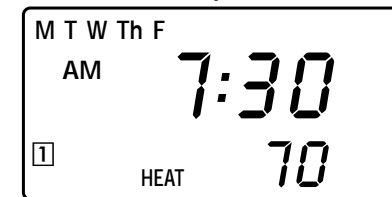

Step 5

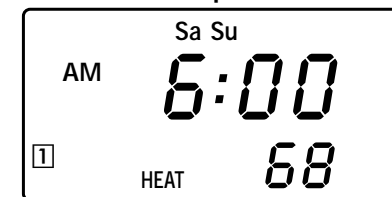

7-Day Programming

Step 1

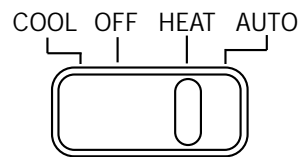

■ Slide System Selector Switch to HEAT or COOL to program the corresponding system.

Step 2



■ Press to enter program mode, display shows weekday programs.





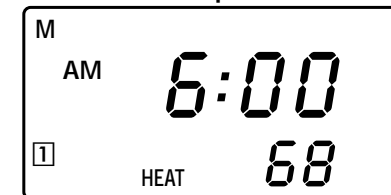

■ Press 2 times to reach the Monday program.

Step 2

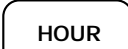

Step 3

Use  and  to change the setpoint time.

Use  and  to change the setpoint temperature.

Step 3

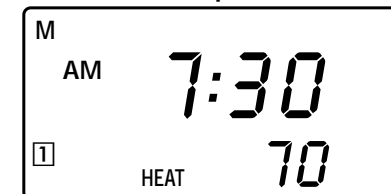

Step 4

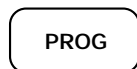

■ Press to move to programs 2, 3 and 4.
■ Repeat Step 3 to complete the programs for Monday.

Step 5



■ Press to change to the next day's programs.
■ Repeat Steps 3 and 4 to complete the selected day's programs.
■ Continue repeating Steps 3, 4 and 5 to program all 7 days of the week.

Step 5

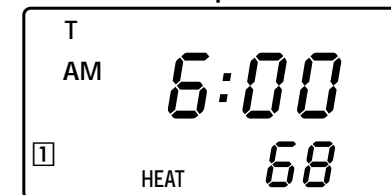

Step 6



■ When finished press to return to normal mode.
■ After 15 seconds, the thermostat will return to normal mode automatically.

7-Day Programming (cont.)

Step 7

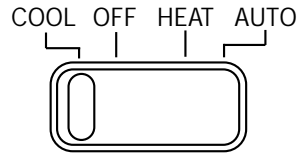

■ Change the System Selector Switch to the other system, and repeat Steps 2 through 6 above.

Reviewing Programs

You may want to review the programs to confirm that the settings are compatible with your lifestyle.

Weekday Programs



- Press to display M – F programs.
- Press repeatedly to cycle through the 4 programs.

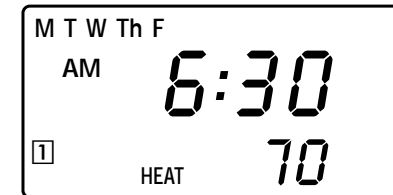

Weekend Programs

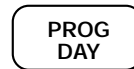

- Press to display the Sa – Su programs.



- Press repeatedly to cycle through the 4 programs.

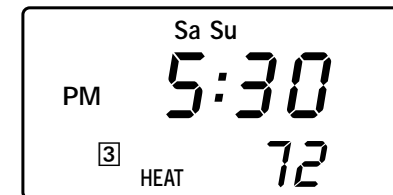

Daily Programs

PROG

- Press to display M – F programs.

NOTE: Time and Temperature display will be blank when at least one weekday program is different.

PROG
DAY

- Press to change to Sa – Su. Again, if the display is blank, one of the weekend programs is different.

- Press again to change to Monday's program.

- Continue pressing to cycle through each day.

PROG

- Press repeatedly to cycle through the 4 programs.

RETURN

- Press to return to normal mode.

- After 15 seconds, the thermostat will return to normal mode automatically.

M T W Th F

M
AM 5:30
[1] HEAT 79

NOTE: Programs take affect as soon as the thermostat returns to normal mode.

If you are armchair programming the thermostat, slide the system selector to the OFF position before mounting the thermostat to the wallplate.

Reviewing the Current Temperature Setting

- Current time and temperature.

- Thermostat is set to AUTO, and the heating system is on.



or



- Press for 1 second or less.

- Set Temperature is shown above current room temperature.

- If held for over 1 second, Temporary Manual Override mode is entered. Refer to the next page.

Sa
PM 9:15
[3] AUTO HEAT TEMP 68

SET TEMP
70
[3] HEAT TEMP 68

System Selector Switch

The System Selector switch on the front of the thermostat determines the operating mode of the thermostat. You may select COOL, OFF, HEAT, AUTO. In order to take full advantage of this thermostat's features, we recommend using the AUTO mode. Refer to the Auto Season Changeover information on page 26.

NOTE: *Anytime you install or remove the thermostat from the wallplate, slide the System Selector to the OFF position to prevent the possibility of a rapid system On-Off.*

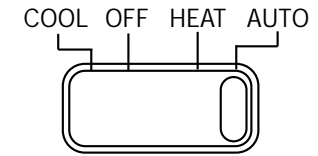

Fan Switch



The Fan switch should normally be set in the AUTO position. The Fan will be turned on along with normal operation of your system. In a normal gas or oil furnace, the Fan will be turned on by your furnace after its warm-up delay. For electric heat, air conditioning, and heat pump operation, the Fan will turn on with the system.

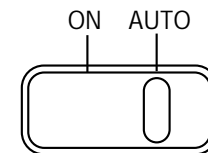

To run the Fan continuously, slide the Fan switch to the ON position.



Temporary Manual Override

To temporarily change the current set temperature without affecting your program:

Press and hold  or  for about 1 second to enter Manual Override mode. Display will flash.

Press  and  to change to your desired new temperature.

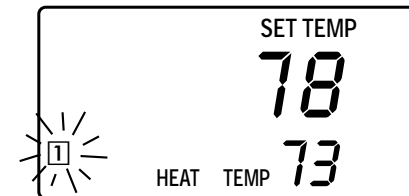

■ Press to return to normal mode, or wait 15 seconds for it to return automatically.

■ The current program number will flash to signify the Temporary Override.

At the next program change, the Temporary Override is canceled, and the next program temperature becomes the setpoint temperature.

To end the Temporary Manual Override:



- Press and wait for HOLD to display on the LCD.
- Press again. This will return the set temperature to the current program set temperature.



NOTE: *The Auto Season Changeover feature will not operate while the thermostat is in Temporary Manual Override. Refer to the Auto Season Changeover feature on page 26 for more information.*

NOTE: *If the thermostat has not been programmed, then a Temporary Override becomes a Permanent Override. See the next section for more information.*

Permanent Manual (Vacation) Override

To hold your manual override for vacation or just an extended period of time:



- Press to make the current program's temperature the HOLD temperature. HOLD will alternate on the display with the normal time and temperature display.
- Follow the Temporary Override Instructions above to change the Permanent Override temperature.
- You can confirm the held set temperature by pressing either  or  for less than 1 second.

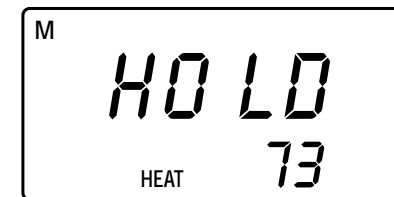

To end the Permanent Manual Override:



- Press again. The thermostat will return to the current program, and the flashing HOLD display will be canceled.

NOTE: *The Auto Season Changeover feature will not operate while the thermostat is in Permanent Manual Override. Refer to the Auto Season Changeover feature on page 26 for more information.*



Auto Season Changeover

When the System Selector is in AUTO position, the thermostat will automatically change between Heating and Cooling systems, depending on your program. We recommend keeping your programmed heating and cooling temperatures at least 4°F (2°C) apart to allow the Auto Season Changeover to occur when the appropriate temperature span has been reached. However, if your heating and cooling programs set temperatures are close, there is a built-in program to prevent the thermostat from changing unnecessarily.

Auto Season Changeover is disabled when the thermostat is in Temporary or Permanent Override, as these overrides are energy

saving settings. Auto Season Changeover will still function in Home Today mode, as this is a comfort setting.

For example, you may have the following temperatures programmed at a given time:

Heat Set Temp = 68°F

Cool Set Temp = 78°F

If the room temperature rises above 78°F, then the thermostat will automatically change to cool mode and turn on the air conditioner.

Likewise, the thermostat will automatically change to heat mode and turn on heat when the room temperature falls below 68°F.

Home Today

This Hunter patent pending feature allows you to quickly and temporarily override your energy saving program setting on days when you are normally away from home with one key press.



- Press to enter the Home Today override. The highest program temperature for today will be selected from your programs in Heat mode and become the set temperature. (In Cool mode, Home Today will select the lowest program temperature for today to be the set temperature.)
- The display will alternate between "HOME" and the current time.
- When pressed during the first or second program of the day, Home Today will automatically return to program control at the start of the fourth program of the day. If Home Today is pressed after the start of the third program time of the day, the thermostat will remain in Home Today mode until the first program of the next day.

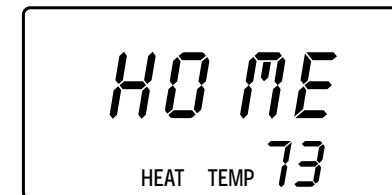



- If Home Today is already active, you may similarly extend it to the first program of the next day by pressing the key again after the start time of the third program.
- If the system is changed between Heat and Cool modes (either manually or by Auto Season Changeover) during the "Home Today" override period, the setpoint temperature will be automatically updated. It will automatically change from the highest heat program setpoint to the lowest cool program setpoint, or from the lowest cool program setpoint to the highest heat program setpoint.



- Press to exit Home Today mode before the schedule ending time. "HOME" is no longer displayed on the LCD screen, and the thermostat returns to the current program.
- You can manually change the setpoint temperature while in Home Today mode. Refer to the Temporary Manual Override instructions on page 24. Manually changing the set temperature while in Home Today mode will not affect the Home Today ending time. *However, the set temperature will not change automatically with a manual or Automatic change between heating and cooling.*
- You may also press the Home Today key while in Temporary Manual Override. The operation is the same as the previous point above.



NOTE: *The Home Today feature does not operate if the thermostat is not programmed by Auto or Manual programming.*



Energy Monitor

The Energy monitor feature measures and stores the amount of time the heating and air conditioning system operates. Usage can be displayed for Today (since 12am), Yesterday, This Week (since Monday), Last Week (last Monday through Sunday), and

Total (up to 999 Hrs. 59 Min.). By monitoring your energy usage, you see how much the set-back periods are saving and you can test program adjustment to save even more. Use table on page 18.



- To review energy usage, press to cycle through Today, Yesterday, This Week, Last Week, and Total. Press again to return to normal mode, or wait 15 seconds for the display to return to normal mode. You can also return to normal mode at any time by pressing RETURN.
- For example: This LCD display shows Today's usage to be 10 Hours, 26 minutes.

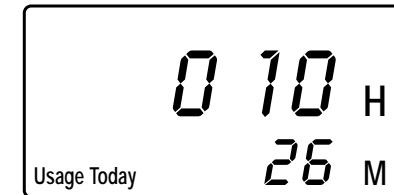

- Press and hold for 3 seconds to reset the Energy Monitor's counters. The display will blink, and all counters will be cleared to zero.

NOTE: *Clearing the Energy Monitor counter will also clear the Filter Monitor counter, as Filter usage and Total Energy usage are the same. Also, clearing the Filter Monitor counter will clear ALL Energy Monitor counters as well.*

Filter Monitor

Your thermostat also keeps a record of the number of hours your filter has been in use. To maximize your system's performance and energy efficiency, change or clean your filter regularly.

FILTER

- When the total system run time for heat and cool reaches 500 hours, "FILT" will alternate with the current time on the LCD display to remind you to clean or change your system's filter. "FILT" will continue to flash until the counter is set back to zero.
- Press to review total filter usage. The display will blink "FILT," then show the Filter Monitor counter. After 15 seconds, the display will return to normal mode, or you can hit RETURN to exit immediately. The Filter Monitor will display up to 999 hours and 59 minutes of usage. In this example, the counter is at 410 Hours, 26 minutes.
- To reset the Filter Monitor counter, depress FILTER for 3 seconds. The display will blink, and the counter will be reset to zero.

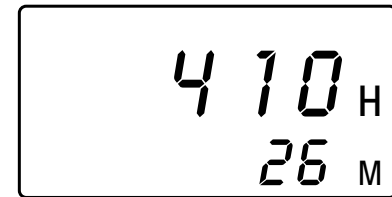
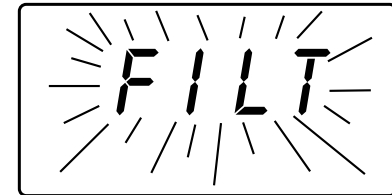

NOTE: *Clearing the Filter Monitor counter will also clear ALL Energy Monitor counters, as Filter usage and Total Energy usage are the same. Also, clearing the Energy Monitor counters will clear the Filter Monitor counter as well.*



Auto Recovery

Hunter's Auto Recovery feature meets the ENERGY STAR® guidelines for energy efficiency by allowing the heating or cooling system to recover gradually from an energy-saving setpoint temperature to a comfort setpoint temperature.

Auto Recovery calculates how early to turn your system back On, so that the room temperature is already comfortable by the start of the comfort temperature program period. Auto Recovery works in both Heat and Cool modes.

For example, in Heat mode, you could have the following programs:

Program #4 (Overnight)
Set Temp = 60°F
Time = 10pm

Program #1 (Morning)
Set Temp = 68°F
Time = 6am

The room temperature fell to 60°F overnight. Rather than having the thermostat turning on at 6am, Auto Recovery would note the temperature difference between 60°F and 68°F and turn the Heat on approximately 30 minutes early. Therefore, the room temperature at 6am would be about 68°F instead of 60°F.

- When the thermostat is in Auto Recovery mode, the display will alternate "RECV" with time, and the program indicator will flash.

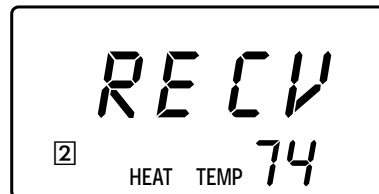



Details of Auto Recovery Operation:

- Auto Recovery can be disabled by sliding the Recovery switch on the circuit board to the ALT position. Refer to page 15.
- Auto Recovery will not operate if Permanent hold, Temporary hold or Home Today is in operation.
- Auto Recovery can be canceled manually if HOLD/CLEAR is pressed during the recovery process. If a recovery process is canceled manually then the recovery process will not start again until the next program period starts (an exception is that if time or program is changed then the thermostat will check Auto Recovery conditions immediately).
- Auto Recovery will be canceled and change to Home Today mode if HOME TODAY is pressed during the recovery process.
- Auto Recovery will be canceled and change to Temporary Manual Override mode if the setpoint is adjusted during the recovery process.
- If the system changes between heat and cool (automatically or manually) then the thermostat will recalculate Auto Recovery again. Setpoint temperature will be changed to the opposite system's comfort temperature if the recovery entry criteria are still met. Otherwise, the recovery process will be canceled and return to program control mode.

Keyboard Lock

The Keyboard can be locked to prevent unauthorized changes to the thermostat.

- To lock or unlock the keyboard, press and hold BOTH the  and  keys for 3 seconds. The keyboard is locked when LOCK appears on the display.

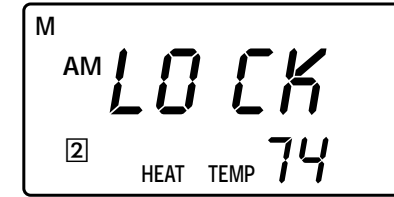

- All keys are locked, except for the LIGHT bar. Any time a key is pressed, LOCK will appear on the display for 1 second.

Backlighting (INDIGLO® night-light)

Your thermostat has an electroluminescent lamp that backlights the display for easy viewing in the dark.



- Press the Light Bar on the left side of the thermostat to illuminate the display.
- The display will remain illuminated for 5 seconds after the last key is pressed.
This allows the light to stay on if you need to operate several keys.

Note: If the thermostat is in Low Battery warning condition, the backlight will not operate. Replace with 2 new AA alkaline batteries to restore the Backlight function.

Low Battery Warning

Your thermostat has a two-stage low battery warning system. When the batteries are first detected to be weak, the first stage low battery warning is indicated by "BATT" flashing on the LCD

display alternatively with the clock. You then need to replace the batteries with 2 new AA alkaline batteries.

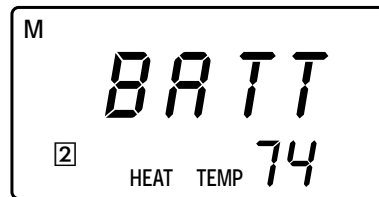

NOTE: The backlight will not operate in low battery condition. Replace with 2 new AA alkaline batteries to restore the Backlight function.

When the batteries become too weak for normal operation, the thermostat enters the second stage low battery warning which shuts down the thermostat. In this condition, "BATT" flashes

alone on the display, and the thermostat will turn your system Off. Your system will remain shut-off until the batteries are replaced.

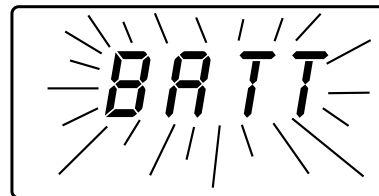

NOTE: The thermostat will still keep the current time and your programs in memory until new batteries are installed. After confirming new batteries have been inserted, the thermostat will return to normal operation.

Error Mode

If the thermostat is unable to control your system due to an unexpected battery problem, the thermostat will enter Error Mode. In this condition, the thermostat flashes "ERR-" on the LCD display, and shuts off your system.

To correct this problem, replace the batteries with 2 new AA alkaline batteries, even if you have recently replaced them. Next,

use a paper clip to press the RESET button next to the keypad. You will need to reprogram your thermostat and confirm normal operation.

If Error Mode returns, please call Hunter Technical support at (901) 745-9222 for further information.

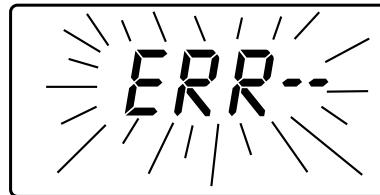

Auto Cut-Off

Your thermostat will automatically cut-off in Heat mode if the room temperature rises above 95°F (35°C). It will cut-off in Cool mode if the room temperature drops below 40°F (4°C).

NOTE: If your system has malfunctioned and no longer responds to thermostat controls, the Auto Cut-Off will have no effect.

Problem**Solution**

**SCRAMBLED OR DOUBLE DISPLAY
(numbers over numbers)**

1. Remove clear mylar sticker

NO DISPLAY

1. Check battery connections and batteries.
2. Press RESET button with a small pin and hold in for two seconds.

ENTIRE DISPLAY DIMS

1. Replace Batteries

**PROGRAM DOES NOT CHANGE AT YOUR
DESIRED SETTING**

1. Check that the time is set properly to "AM" or "PM".
2. Check that the thermostat is not in "HOLD" or "Home Today" modes.
3. Check for the correct day setting.

AUTO / FAN DOES NOT TURN ON

1. Move HG/HE selector to opposite position

HEATING OR COOLING DOES NOT GO ON OR OFF

1. Check that the system selector switch is in the correct position ("HEAT," "COOL" or "AUTO").
2. The thermostat may be in the AUTO mode. Look for "AUTO" on the LCD display. If the Heat and Cool program temperatures are close, then the thermostat requires a larger room temperature change before changing from Heat or Cool.
3. There may be as much as a 4 minute delay before the Heat or Cool system turns On – wait and check. (Compressor protection delay.)
4. Check your circuit breakers and switches to ensure there is power to the system.
5. Replace batteries.
6. Make sure your furnace blower door is closed properly.
7. If your system only uses 4-wires, be sure the jumper wire is installed between the RC and RH terminals.
8. Check the position of the Furnace or Heat Pump selector switch: Normal / O / B.

Problem (cont.)**Solution (cont.)**

ERRATIC DISPLAY

1. Press the RESET button once with a small pin and hold for two seconds.
The thermostat will need to be reprogrammed.

IF UNIT CONTINUES TO OPERATE IN THE OFF POSITION

1. Replace unit.

**THERMOSTAT PERMANENTLY READS "HI," "LO,"
OR "ERR-" AFTER PRESSING RESET BUTTON**

1. Replace unit.

If you experience any other problems, call 901-745-9222 from 8 AM to 5 PM Central Time for technical assistance.

4-wire Heat/Cool System

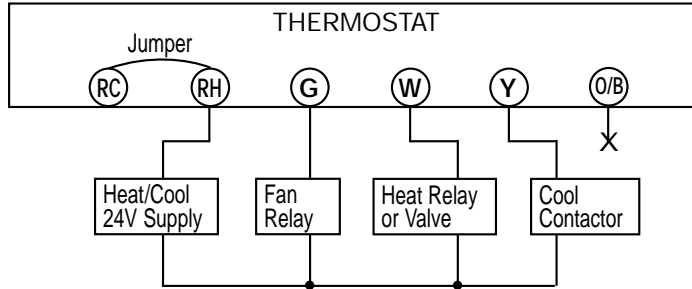

5-wire Heat/Cool System

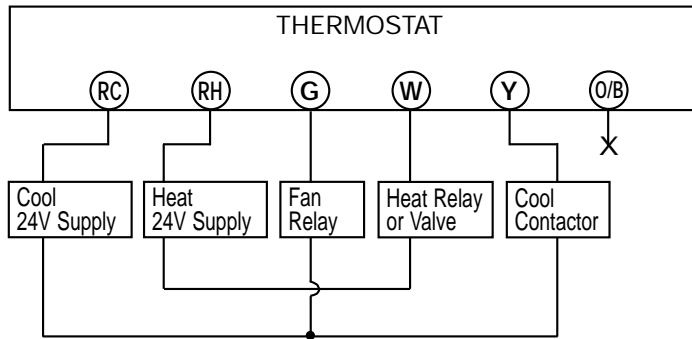

X - No Connection

Single-stage Heat Pump

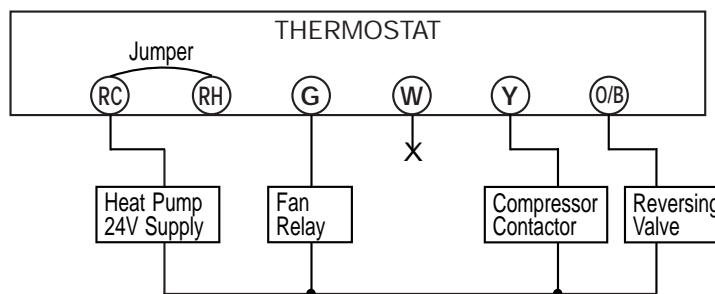

2-wire Heat Only

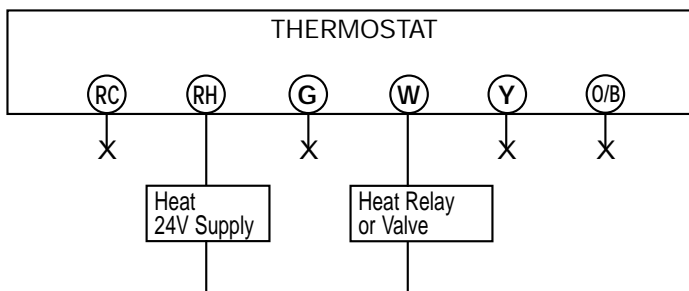

X - No Connection

3-wire Heat Only

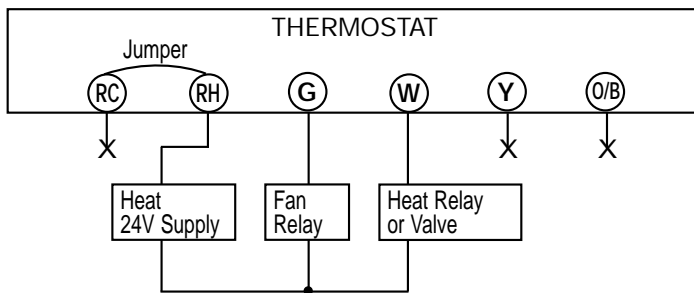

3-wire Cool Only

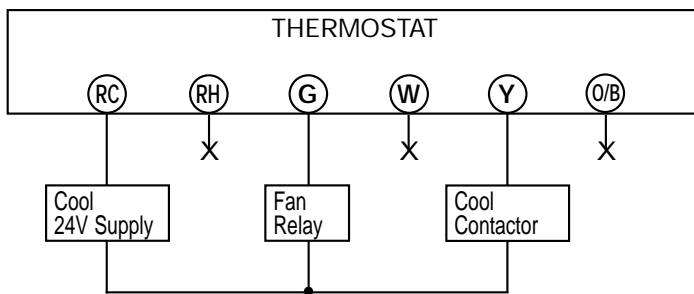

X - No Connection

Free Manuals Download Website

<http://myh66.com>

<http://usermanuals.us>

<http://www.somanuals.com>

<http://www.4manuals.cc>

<http://www.manual-lib.com>

<http://www.404manual.com>

<http://www.luxmanual.com>

<http://aubethermostatmanual.com>

Golf course search by state

<http://golfingnear.com>

Email search by domain

<http://emailbydomain.com>

Auto manuals search

<http://auto.somanuals.com>

TV manuals search

<http://tv.somanuals.com>