

Operator's Manual

125C 125L

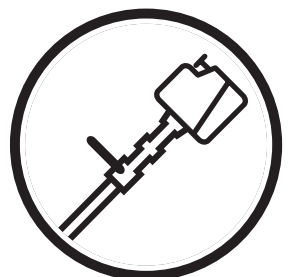

Please read the operator's manual carefully and make sure you understand the instructions before using the machine.

English

CONTENTS

Contents

CONTENTS

Contents	2
Note the following before starting	2
KEY TO SYMBOLS	
Symbols	3
SAFETY INSTRUCTIONS	
Personal protective equipment	4
Machine's safety equipment	4
Cutting equipment	5
Checking, maintaining and servicing the machine's safety equipment	5
General safety precautions	8
Starting safety	8
Fuel safety	8
Transporting and storage	9
General working instructions	9
Basic safety rules	9
Basic working techniques	9
KNOW YOUR TRIMMER	
Know your trimmer	11
ASSEMBLY	
Fitting the loop handle	12
Fitting the trimmer guard and trimmer head	12
FUEL HANDLING	
Fuel	13
Fueling	13
STARTING AND STOPPING	
Check before starting	14
Starting and stopping	14
MAINTENANCE	
Carburetor	16
Muffler	16
Spark plug	17
Air filter	17
Bevel gear	17
Maintenance schedule	18
TECHNICAL DATA	
Technical data	20
YOUR WARRANTY RIGHTS AND OBLIGATIONS	21
EMISSION CONTROL	
WARRANTY STATEMENT	22

Note the following before starting:

Husqvarna AB has a policy of continuous product development and therefore reserves the right to modify the design and appearance of products without prior notice. Long-term exposure to noise can result in permanent hearing impairment. Always use approved hearing protection. Maintenance, replacement, or repair of the emission control devices and system may be performed by any nonroad engine repair establishment or individual.

WARNING! The engine exhaust from this product contains chemicals known to the State of California to cause cancer, birth defects or other reproductive harm.

The Emissions Compliance Period referred to on the Emissions Compliance label indicates the number of operating hours for which the engine has been shown to meet Federal emissions requirements. Category C = 50 hours, B= 125 hours, and A = 300 hours.

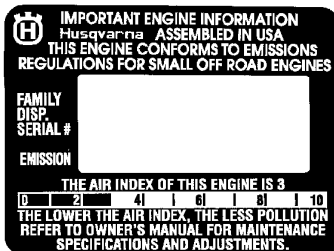

For reference, please fill out the following information that will be needed for future servicing of your trimmer:

Model Number: _____

Serial Number: _____

Purchase Date: _____

Purchased From: _____

WARNING! A clearing saw, brushcutter or trimmer can be dangerous if used incorrectly or carelessly, and can cause serious or fatal injury to the operator or others. It is extremely important that you read and understand the contents of this operator's manual.

WARNING! Under no circumstances may the design of the machine be modified without the permission of the manufacturer. Always use genuine accessories. Non-authorized modifications and/or accessories can result in serious personal injury or the death of the operator or others. Your warranty may not cover damage or liability caused by the use of non-authorized accessories or replacement parts.

KEY TO SYMBOLS

Symbols

WARNING! Clearing saws, brushcutters and trimmers can be dangerous! Careless or incorrect use can result in serious or fatal injury to the operator or others.



Please read the operator's manual carefully and make sure you understand the instructions before using the machine.



Always wear:

- A protective helmet where there is a risk of falling objects
- Hearing protection
- Approved eye protection



Max. speed of output shaft, rpm



Watch out for thrown objects and ricochets.



The operator of the machine must ensure, while working, that no persons or animals come closer than 50 feet (15 meters).



Arrows which show limits for handle positioning.



Always wear approved protective gloves.



Wear sturdy, non-slip boots.



Only use non-metallic, flexible cutting attachments, i.e. trimmer heads with trimmer line.



Only intended for trimmer heads.



Other symbols/decals on the machine refer to special certification requirements for certain markets.

Stop the engine by pushing and holding the stop switch in the STOP position until the engine stops before carrying out any checks or maintenance.



Regular cleaning is required.



Visual check.



Approved eye protection must always be used.



SAFETY INSTRUCTIONS

Personal protective equipment

IMPORTANT! Whenever you use a clearing saw, brushcutter or trimmer you must wear personal protective equipment that is approved by the authorities. Personal protective equipment does not eliminate the risk of accidents, but it can reduce the effects of an injury in the event of an accident. Ask your dealer for help when choosing protective equipment.

WARNING! Listen out for warning signals or shouts when you are wearing hearing protection. Always remove your hearing protection as soon as the engine stops.

GLOVES

Gloves should be worn when necessary, e.g., when fitting cutting attachments.



HEARING PROTECTION

Wear hearing protection that provides adequate noise reduction.

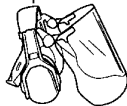

EYE PROTECTION

Always wear approved eye protection. If you use a visor then you must also wear approved protective goggles. Approved protective goggles must comply with standard ANSI Z87.1.



BOOTS

Wear sturdy, non-slip boots.



CLOTHING

Wear clothes made of a strong fabric and avoid loose clothing that can catch on twigs and branches. Always wear heavy, long pants. Do not wear jewelry, shorts sandals or go barefoot. Secure hair so it is above shoulder level.

FIRST AID KIT

Always have a first aid kit nearby.



Machine's safety equipment

This section describes the machine's safety equipment, its purpose, and how checks and maintenance should be carried out to ensure that it operates correctly. See the "Know your trimmer" section to locate where this equipment is positioned on your machine.

The life span of the machine can be reduced and the risk of accidents can increase if machine maintenance is not carried out correctly and if service and/or repairs are not carried out professionally. If you need further information please contact your nearest servicing dealer.

WARNING! Never use a machine that has faulty safety equipment! Carry out the inspection, maintenance and service routines listed in this section.

Throttle lock

The throttle lock is designed to prevent accidental operation of the throttle control. When you press the lock (A) (i.e. when you grasp the handle) it releases the throttle control (B). When you release the handle the throttle control and the throttle lock both move back to their original positions. This movement is controlled by two independent return springs. This arrangement means that the throttle control is automatically locked at the idle setting.

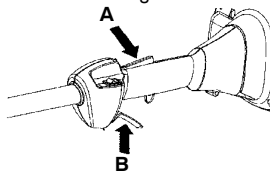

Stop switch

Make sure the engine stops when you push and hold the stop switch.

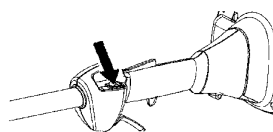

SAFETY INSTRUCTIONS

Cutting attachment guard

This guard is intended to prevent loose objects from being thrown towards the operator. The guard also protects the operator from accidental contact with the cutting attachment.

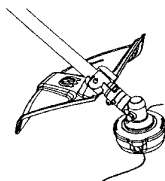

WARNING! Never use a cutting attachment without an approved guard. See the section on "Technical data". If an incorrect or faulty guard is fitted this can cause serious personal injury.

Use of incorrectly wound trimmer line or an incorrect cutting attachment increases the level of vibration.

WARNING! Overexposure to vibration can lead to circulatory damage or nerve damage in people who have impaired circulation. Contact your doctor if you experience symptoms of overexposure to vibration. Such symptoms include numbness, loss of feeling, tingling, pricking, pain, loss of strength, changes in skin color or condition. These symptoms normally appear in the fingers, hands or wrists. The risk increases at low temperatures.

Muffler

The muffler is designed to reduce the noise level and to direct the exhaust gases away from the operator.

CAUTION! Muffler is fitted with a catalytic converter designed to reduce harmful exhaust gases.



For mufflers, it is very important that you follow the instructions on checking, maintaining, and servicing your machine. See Checking, maintaining and servicing the machine's safety equipment section.

WARNING! Mufflers fitted with catalytic converters get very hot during use and remain so for some time after stopping. This also applies at idle speed. Contact can result in burns to the skin. Remember the risk of fire!

WARNING! The inside of the muffler contain chemicals that may be carcinogenic. Avoid contact with these elements in the event of a damaged muffler.

WARNING! Bear in mind that: Engine exhaust fumes contain carbon monoxide, which can cause carbon monoxide poisoning. For this reason you should not start or run the machine indoors, or anywhere that is poorly ventilated. The exhaust fumes from the engine are hot and may contain sparks which can start a fire. Never start the machine indoors or near combustible material!

Cutting equipment

A trimmer head is intended for trimming grass.

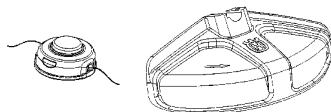

Checking, maintaining and servicing the machine's safety equipment

IMPORTANT! All servicing and repair work on the machine requires special training. This is especially true of the machine's safety equipment. If your machine fails any of the checks described below you must contact your service agent. When you buy any of our products we guarantee the availability of professional repairs and service. If the retailer who sells your machine is not a servicing dealer, ask him for the address of your nearest service agent.

SAFETY INSTRUCTIONS

Throttle lock

- Make sure the throttle control is locked at the idle setting when the throttle lock is released.

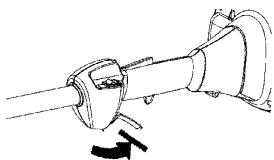

- Press the throttle lock and make sure it returns to its original position when you release it.

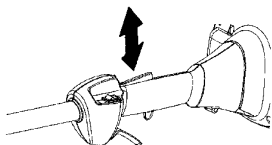

- Check that the throttle control and throttle lock move freely and that the return springs work properly.

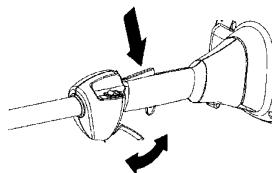

- See instructions under the section "Start". Start the machine and apply full throttle. Release the throttle and check that the cutting attachment stops and remains at a standstill. If the cutting attachment rotates with the throttle in the idle position then the carburetor idle setting must be checked. See instructions under the section "Maintenance".

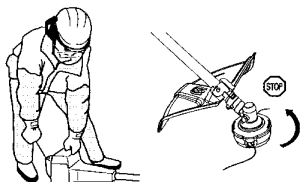

Stop switch

- Start the engine and make sure the engine stops when you push and hold the stop switch.

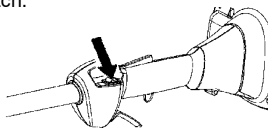

Cutting attachment guard



- Ensure that the guard is undamaged and is not cracked.

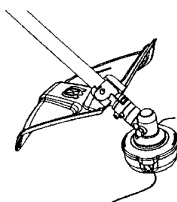

- Replace the guard if it has been exposed to impact or is cracked.
- Always use the recommended guard for the cutting attachment you are using. See section on "Technical data".

Muffler



- Never use a machine that has a faulty muffler.

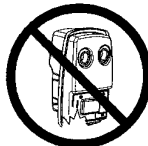

- Regularly check that the muffler is securely attached to the machine.

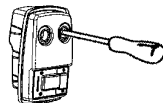

- The muffler on this unit is equipped with a special spark arrestor mesh. The mesh should be checked and, if necessary, cleaned by a servicing dealer. A blocked mesh will cause the machine to overheat, which can lead to serious damage. Never use a muffler with a defective spark arrestor mesh. See the Maintenance section.

SAFETY INSTRUCTIONS

Cutting equipment

This section describes how to choose and maintain your cutting equipment in order to:

- Obtain maximum cutting performance.
- Extend the life of cutting equipment.

General rules



1. Only use cutting attachments with the guards we recommend! See the section on "Technical Data".

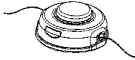

2. Check the cutting attachment for damage or cracks. A damaged cutting attachment should always be replaced.

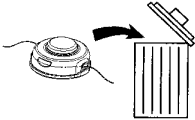

WARNING! Never use a machine with faulty safety equipment. The machine's safety equipment must be checked and maintained as described in this section. If your machine fails any of these checks contact your service agent to get it repaired.

IMPORTANT!

This section describes how to choose and maintain your cutting equipment in order to: Obtain maximum cutting performance. Extend the life of cutting equipment. Only use cutting attachments with the guards we recommend! See the section on "Technical data". Refer to the instructions for the cutting attachment to check the correct way to load the trimmer line and the correct line diameter.

Trimmer head

- Only use the recommended cutting attachments. See the section on "Technical data".

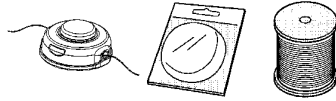

- Smaller machines generally require small trimmer heads and vice versa. This is because when clearing using trimmer line the engine must throw out the trimmer line radially from the trimmer head and overcome the resistance of the grass being cleared.
- The length of the trimmer line is also important. A longer trimmer line requires greater engine power than a shorter trimmer line of the same diameter.
- Make sure that the cutter on the trimmer guard is intact. This is used to cut the trimmer line to the correct length.
- To increase the life of the trimmer line it can be soaked in water for a couple of days. This will make the line tougher so that it lasts longer.

IMPORTANT!

Always ensure the trimmer line is wound tightly and evenly around the drum, otherwise the machine will generate harmful vibration.

WARNING! Always stop the engine before doing any work on the cutting attachment. This continues to rotate even after the throttle has been released. Ensure that the cutting attachment has stopped completely and disconnect the HT lead from the spark plug before you start to work on it.

SAFETY INSTRUCTIONS

General safety precautions

IMPORTANT!

- The machine is only designed for trimming grass.
- The only accessories you can operate with this engine unit are the cutting attachments we recommend in the "Technical data" section.
- Never use wire, rope, string, etc.
- Never use the machine if you are tired, if you have drunk alcohol, or if you are taking medication that could affect your vision, your judgment or your coordination.
- Never use the machine in extreme weather conditions such as severe cold, very hot and/or humid climates.
- Never use a machine that has been modified in any way from its original specification.
- Wear personal protective equipment. See instructions in the "Personal protective equipment" section.
- Never use a machine that is faulty. Carry out the checks, maintenance and service instructions described in this manual. Some maintenance and service measures must be carried out by trained and qualified specialists. See instructions in the "Maintenance" section.
- All covers and guards must be fitted before starting. Make sure the spark plug cap and HT lead are not damaged. Otherwise you could get an electric shock.
- The machine operator must ensure that no people or animals come closer than 15 meters while working.
- Stay clear of spinning line.
- Secure or remove loose clothing or clothing with loosely hanging ties, straps, tassels, etc. They can be caught in moving parts.
- Being fully covered also helps protect you from debris and pieces of toxic plants thrown by spinning line.
- Keep handles free of oil and fuel.
- Always keep the engine on the right hand side of your body.
- Hold the unit firmly with both hands.
- Keep trimmer head below waist level and away from all parts of your body. Do not raise engine above your waist.
- Keep all parts of your body away from muffler and spinning line. Keep engine below waist level. A hot muffler can cause serious burns.
- Keep firm footing and balance. Do not overreach or use from unstable surfaces such as ladders, trees, steep slopes, rooftops, etc.
- Use only in daylight or good artificial light.
- Use only for jobs explained in this manual.

WARNING! A faulty cutting attachment may increase the risk of accidents.

Starting



WARNING! When the engine is started with the choke in either the choke or start throttle positions the cutting attachment will start to rotate immediately.

- Ensure that all of the engine covers and housings are properly fitted before the trimmer is started.
- Never start or attempt to run the unit with the clutch, clutch drum, clutch cover, or driveshaft removed.
- Never start the machine indoors. Exhaust fumes can be dangerous if inhaled.
- Observe your surroundings and make sure that there is no risk of people or animals coming into contact with the cutting equipment.
- See the "Starting and Stopping" section for complete instructions.

Fuel safety



- Always use a fuel container with an anti-spill valve.
- Never refuel the machine while the engine is running.
- Always stop the engine and let it cool for a few minutes before refueling.
- Make sure there is plenty of ventilation when refueling or mixing fuel (gasoline and 2-stroke oil).
- Move the machine at least 10 feet (3 meters) from the refueling point before starting it.

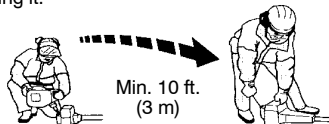

- Never start the machine:
 - If you have spilled fuel on it. Wipe off the spillage and allow remaining fuel to evaporate.
 - If you have spilled fuel on yourself or your clothes, change your clothes. Wash any part of your body that has come in contact with fuel. Use soap and water.

SAFETY INSTRUCTIONS

- If the machine is leaking fuel. Check regularly for leaks from the fuel cap and fuel lines.
- Avoid all skin contact with fuel. Fuel is a skin irritant and may even cause skin changes.

Transporting and storage

- Store and transport the machine and fuel so that there is no risk of any leakage or fumes coming into contact with sparks or naked flames, for example, from electrical machinery, electric motors, electrical relays/switches or boilers.
- When storing and transporting fuel always use approved containers intended for this purpose.
- When storing the machine for long periods the fuel tank must be emptied. Contact your local gas station to find out where to dispose of excess fuel.

WARNING! Take care when handling fuel. Bear in mind the risk of fire, explosion and inhaling fumes.

General working instructions

IMPORTANT!

This section describes the basic safety precautions for working with trimmers. If you encounter a situation where you are uncertain how to proceed you should ask an expert. Contact your servicing dealer. Avoid all usage which you consider to be beyond your capability. You must understand the difference between forestry clearing, grass clearing and grass trimming before use.

Basic safety rules



1. Look around you:
 - To ensure that people, animals or other things cannot affect your control of the machine.
 - To ensure that people, animals, etc., do not come into contact with the cutting attachment or loose objects that are thrown out by the cutting attachment.
 - **CAUTION!** Do not use the machine unless you are able to call for help in the event of an accident.
2. Do not use the machine in bad weather, such as dense fog, heavy rain, strong wind, intense cold, etc. Working in bad weather is tiring and often brings added risks, such as icy ground, unpredictable felling direction, etc.

3. Make sure you can move and stand safely. Check the area around you for possible obstacles (roots, rocks, branches, ditches, etc.) in case you have to move suddenly. Take great care when working on sloping ground.



4. Switch off the engine before moving to another area.
5. Never put the machine down with the engine running.

Basic working techniques

- Always slow the engine to idle speed after each working operation. Long periods at full throttle without any load on the engine can lead to serious engine damage.

WARNING! Sometimes branches or grass get caught between the guard and cutting attachment. Always stop the engine before cleaning.

Grass trimming using a trimmer head

Trimming



- Hold the trimmer head just above the ground at an angle. It is the end of the trimmer line that does the work. Let the trimmer line work at its own pace. Never press the trimmer line into the area to be cut.



- The trimmer line can easily remove grass and weeds up against walls, fences, trees and borders, however it can also damage sensitive bark on trees and bushes, and damage fence posts.
- Reduce the risk of damaging plants by shortening the trimmer line to 4-4 1/2 inches (10-12 cm) and reducing the engine speed.
- When trimming you should use less than full throttle so that the trimmer line lasts longer and to reduce the wear on the trimmer head.

SAFETY INSTRUCTIONS

Clearing



- The clearing technique removes all unwanted vegetation. Keep the trimmer head just above the ground and tilt it. Let the end of the trimmer line strike the ground around trees, posts, statues and the like. **CAUTION!** This technique increases the wear on the trimmer line.

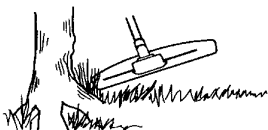

- The trimmer line wears quicker and must be fed forward more often when working against stones, brick, concrete, metal fences, etc., than when coming into contact with trees and wooden fences.

Cutting



- The trimmer is ideal for cutting grass that is difficult to reach using a normal lawn mower. Keep the trimmer line parallel to the ground when cutting. Avoid pressing the trimmer head against the ground as this can ruin the lawn and damage the tool.

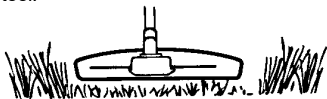

- Do not allow the trimmer head to constantly come into contact with the ground during normal cutting. Constant contact of this type can cause damage and wear to the trimmer head.

Sweeping



- The fan effect of the rotating line can be used for quick and easy clearing up. Hold the trimmer line parallel to and above the area to be swept and move the tool to and fro.

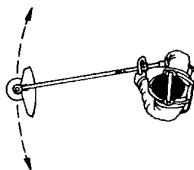

- When cutting and sweeping you should use full throttle to obtain the best results.

WARNING! Neither the operator of the machine nor anyone else may attempt to remove the cut material while the engine is running or the trimmer line is rotating, as this can result in serious injury. Stop the engine and trimmer head before you remove material that has wound around the drive shaft as otherwise there is a risk of injury. The bevel gear can get hot during use and may remain so for a while afterwards. You could get burned if you touch it.

WARNING! Watch out for thrown objects. Always wear eye protection. Never lean over the cutting attachment guard. Stones, rubbish, etc. can be thrown up into the eyes causing blindness or serious injury. Keep unauthorized persons at a distance. Children, animals, onlookers and helpers should be kept outside the safety zone of 50 feet (15 meters). Stop the machine immediately if anyone approaches.

KNOW YOUR TRIMMER

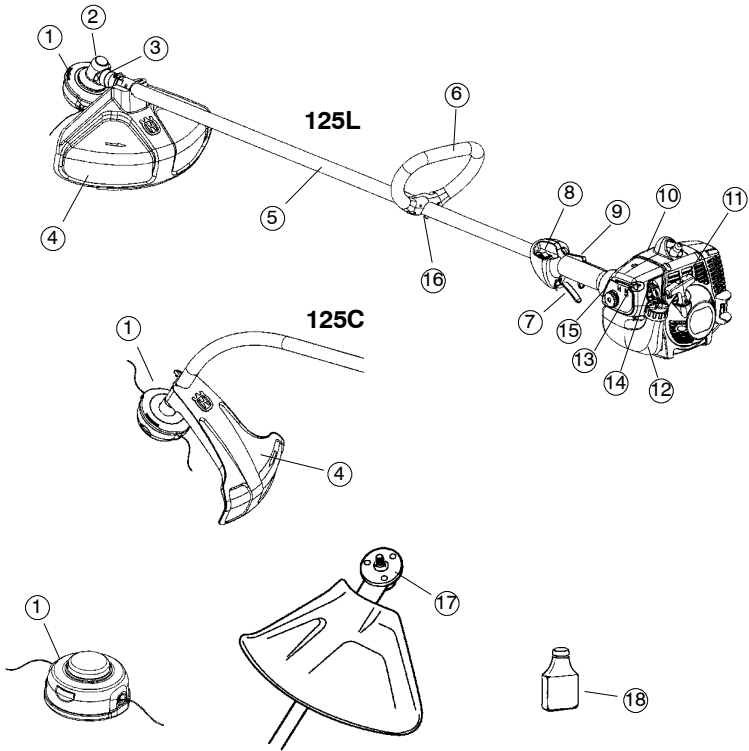

KNOW YOUR TRIMMER

- | | |
|-----------------------------|-----------------------------|
| 1. Trimmer head | 11. Starter handle |
| 2. Grease filler cap | 12. Fuel tank |
| 3. Bevel gear | 13. Choke control |
| 4. Cutting attachment guard | 14. Air purge |
| 5. Shaft | 15. Air filter cover |
| 6. Loop handle | 16. Handle adjustment |
| 7. Throttle control | 17. Drive disc |
| 8. Stop switch | 18. 2-stroke engine oil |
| 9. Throttle lock | 19. Operator's manual (EPA) |
| 10. Cylinder cover | |

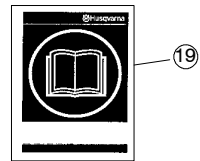

ASSEMBLY

Make sure unit is assembled correctly as shown in this manual.

Fitting the loop handle

- Position the handle on the shaft. Note that the handle must be mounted between the two arrows on the shaft.

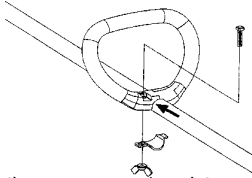

- Fit the screw, securing plate and wing nut as shown in the diagram.
- Tighten the wing nut.

Fitting the trimmer guard and trimmer head (Model 125L)



- Fit the correct trimmer guard (A) for use with the trimmer head. Hook the trimmer guard/combination guard onto the fitting on the shaft and secure with the bolt (D).

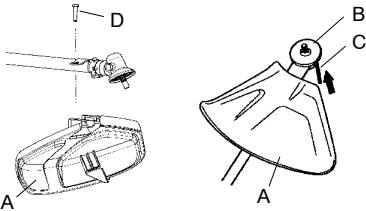

- Fit the drive disc (B) on the output shaft.
- Turn the shaft until one of the holes in the drive disc aligns with the corresponding hole in the gear housing.
- Insert hex wrench (C) in the hole to lock the shaft.
- Screw on the trimmer head (H) in the opposite direction to the direction of rotation.

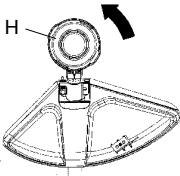

- To dismantle, follow the instructions in the reverse order.

Fitting the trimmer guard and trimmer head (Model 125C)



- Fit the correct trimmer guard (A) for use with the trimmer head. Hook the trimmer guard/combination guard onto the fitting on the shaft and secure with the wing nut (B).

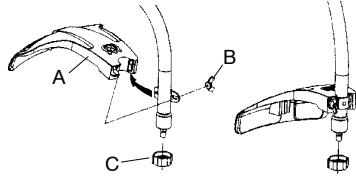

- Fit the dust cup (C) on the shaft. The nut must be completely covered by the dust cup.
- Hold the dust cup with a wrench to prevent the shaft from rotating.
- Screw the trimmer head (D) onto the shaft.

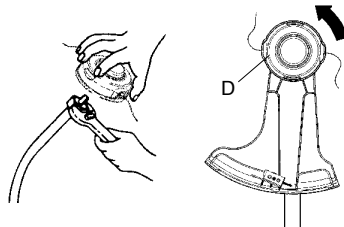

- To dismantle, follow the instructions in the reverse order.

FUEL HANDLING

Fuel

CAUTION! The machine is equipped with a two-stroke engine and must always be run using a mixture of gasoline and two-stroke engine oil. It is important to accurately measure the amount of oil to be mixed to ensure that the correct mixture is obtained. When mixing small amounts of fuel, even small inaccuracies can drastically affect the ratio of the mixture.

WARNING! Always ensure there is adequate ventilation when handling fuel.

Gasoline



CAUTION! Always use high quality unleaded gasoline.

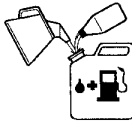

- This engine is certified to operate on unleaded gasoline.
- The lowest recommended octane rating is 87. If you run the engine on lower octane rating than 87, "knocking" can occur. This leads to an increased engine temperature, which can result in a serious engine breakdown.
- When working at continuous high revs a higher octane rating is recommended.

Two-stroke oil

- For great results and performance use HUSQVARNA two-stroke oil, which is specially formulated for our two-stroke engines. Mixture 1:50 (2%).
- To maximize the life of your trimmer, you may choose to use a high quality synthetic oil formulated for two-stroke engines. Mixture 1:50 (2%).
- Never use two-stroke oil intended for water-cooled outboard engines, sometimes referred to as outboard oil.
- Never use oil intended for four-stroke engines.

Gasoline	Two-stroke oil
	2% (1:50)
U.S. gallon	U.S. fl. oz.
1	2 1/2
2 1/2	6 1/2
5	12 7/8

Mixing

- Always mix the gasoline and oil in a clean container intended for fuel.

- Always start by filling half the amount of the gasoline to be used. Then add the entire amount of oil. Mix (shake) the fuel mixture. Add the remaining amount of gasoline.
- Mix (shake) the fuel mixture thoroughly before filling the machine's fuel tank.

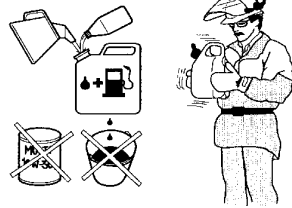

- Do not mix more than one month's supply of fuel at a time.
- If the machine is not used for some time, the fuel tank should be emptied and cleaned.

WARNING! The catalytic converter muffler gets very hot during and after use. This also applies during idling. Be aware of the fire hazard, especially when working near flammable substances and/or vapors.

Fueling



WARNING! Taking the following precautions, will lessen the risk of fire:
Do not smoke or place hot objects near fuel.
Always shut off the engine before refueling.
Always stop the engine and let it cool for a few minutes before refueling.
When refueling, open the fuel cap slowly so that any excess pressure is released gently.
Tighten the fuel cap carefully after refueling.
Always move the machine away from the refueling area before starting.

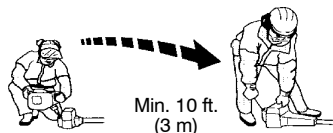

STARTING AND STOPPING

- Clean the area around the fuel cap. Contamination in the tank can cause operating problems.
- Ensure that the fuel is well mixed by shaking the container before filling the tank.

Check before starting



- Inspect the unit before each use. Replace damaged parts. Check for fuel leaks. Make sure all fasteners are in place and secure. Make sure the cutting attachment is properly installed and securely fastened. Use only flexible, non-metallic line recommended by the manufacturer. Never use, for example, wire or wire rope, which can break off and become a dangerous projectile.
- Check that the trimmer head and trimmer guard are not damaged or cracked. Replace the trimmer head or trimmer guard if they have been exposed to impact or are cracked.

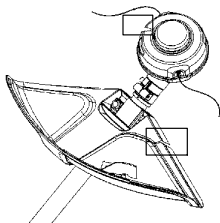

- Never use the machine without a guard nor with a defective guard.

Starting and stopping



WARNING! The complete clutch, clutch cover, and shaft must be fitted before the machine is started, otherwise parts could come loose and cause personal injury. Always move the machine away from the refueling area before starting. Place the machine on a flat surface. Ensure the cutting attachment cannot come into contact with any object. Make sure no unauthorized persons are in the working area, otherwise there is a risk of serious personal injury. The safety distance is 50 feet (15 meters).

Cold engine

Air purge: Press the air purge diaphragm 6 - 10 times until fuel begins to fill the diaphragm. The diaphragm need not be completely filled.

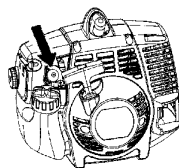

Choke: Move the blue engine choke lever over to the closed position.

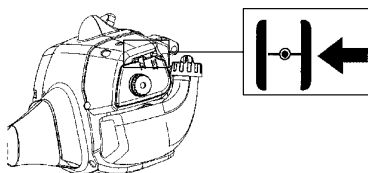

Starting

Hold the body of the machine on the ground using your left hand (**CAUTION!** Not with your foot!).

Grip the starter handle. Slowly pull out the cord with your right hand until you feel some resistance (the starter pawls grip); then quickly and powerfully pull the cord.

Never wrap the starter cord around your hand.

Repeat pulling the cord until the engine attempts to start. Squeeze throttle trigger to release the choke and pull starter rope until engine runs.

NOTE: If engine dies, return blue engine choke lever to the closed position and repeat starting steps.

CAUTION! Do not pull the starter cord all the way out and do not let go of the starter handle when the cord is fully extended. This can damage the machine.

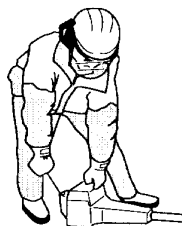

STARTING AND STOPPING

Warm engine

With a warm engine, squeeze and hold the throttle trigger. Pull starter rope sharply while squeezing throttle trigger until engine runs.

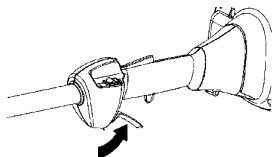

Stopping

Stop the engine by pushing and holding the stop switch in the STOP position until the engine stops.

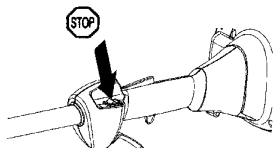

WARNING! When the engine is started with the choke in the closed position the cutting attachment will start to rotate immediately.

MAINTENANCE

The owner is responsible for the performance of all required maintenance as defined in the operator's manual.

Carburetor

Your Husqvarna product has been designed and manufactured to specifications that reduce harmful emissions. After the engine has used 8-10 tanks of fuel, the engine will be run-in. To ensure that it continues to run at peak performance and to minimize harmful exhaust emissions after the run-in period, ask your servicing dealer to adjust your carburetor.

WARNING! The complete clutch, clutch cover, and shaft must be fitted before the machine is started, otherwise parts could come loose and cause personal injury.

Function



- The carburetor governs the engine's speed via the throttle control. Air and fuel are mixed in the carburetor.
- The T-screw regulates the throttle setting at idle speed. If the T-screw is turned clockwise this gives a higher idle speed; turning it counterclockwise gives a lower idle speed.

Basic setting

- The basic carburetor settings are adjusted during testing at the factory. Fine adjustment should be carried out by a skilled technician.

CAUTION! If the cutting attachment rotates when the engine is idling the idle adjustment screw T should be turned counterclockwise until the cutting attachment stops.

Rec. idle speed:

See "Technical data" section.

Recommended max. speed:

See "Technical data" section.

WARNING! If the idle speed cannot be adjusted so that the cutting attachment stops, contact your dealer/service workshop. Do not use the machine until it has been correctly adjusted or repaired.

Fine adjustment of the idle speed-T

Adjust the idle speed using the idle adjustment screw-T if it is necessary to readjust. First, turn the idle adjustment screw-T clockwise until the cutting attachment starts to rotate. Then, turn the screw counterclockwise until the cutting attachment stops.

The idle speed is correctly adjusted when the engine will run smoothly in every position. The idle speed should also be well below the speed at which the cutting attachment starts to rotate.

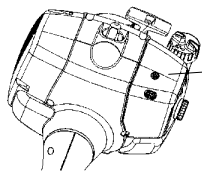

Idle Speed Screw-T

WARNING! If the idle speed cannot be adjusted so that the cutting attachment stops, contact your servicing dealer. Do not use the machine until it has been correctly adjusted or repaired.

Unit/Maintenance Safety

Disconnect the spark plug before performing maintenance, except carburetor adjustments.

Muffler



CAUTION! Muffler is fitted with a catalytic converter designed to reduce harmful exhaust gases.

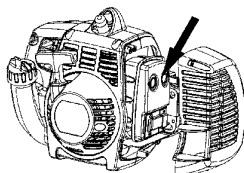

The muffler is designed to reduce the noise level and to direct the exhaust gases away from the operator. The exhaust gases are hot and can contain sparks, which may cause fire if directed against dry and combustible material.

Mufflers are equipped with a special spark arrester mesh. The mesh should be checked and, if necessary, cleaned by a servicing dealer. **If the mesh is damaged, it should be replaced.** If the mesh is frequently blocked, this can be a sign that the performance of the catalytic converter is impaired. Contact your servicing dealer to inspect the muffler. A blocked mesh will cause the machine to overheat and result in damage to the cylinder and piston.

MAINTENANCE

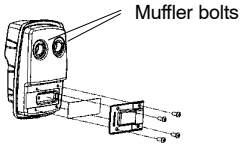

CAUTION! Never use a machine that has a faulty or loose muffler. Ensure the muffler bolts are tight.



WARNING! Mufflers fitted with catalytic converters get very hot during use and remain so for some time after stopping. This also applies at idle speed. Contact can result in burns to the skin. Remember the risk of fire!



WARNING! The inside of the muffler contain chemicals that may be carcinogenic. Avoid contact with these elements in the event of a damaged muffler.



WARNING! Bear in mind that: Engine exhaust fumes contain carbon monoxide, which can cause carbon monoxide poisoning. For this reason you should not start or run the machine indoors, or anywhere that is poorly ventilated. The exhaust fumes from the engine are hot and may contain sparks which can start a fire. Never start the machine indoors or near combustible material!

Spark plug



The spark plug condition is influenced by:

- Incorrect carburetor adjustment.
- An incorrect fuel mixture (too much or incorrect type of oil).
- A dirty air filter.

These factors cause deposits on the spark plug electrodes, which may result in operating problems and starting difficulties.

If the machine is low on power, difficult to start or runs poorly at idle speed: always check the spark plug first before taking any further action. If the spark plug is dirty, clean it and check that the electrode gap is 0.024" (0.6 mm). The spark plug should be replaced after about a month in operation or earlier if necessary.

CAUTION! Always use the recommended spark plug type! Use of the wrong spark plug can damage the piston/cylinder.

0.024" (0.6 mm)

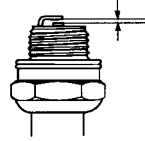

Air filter



The air filter must be regularly cleaned to remove dust and dirt in order to avoid:

- Carburetor malfunctions
- Starting problems
- Loss of engine power
- Unnecessary wear to engine parts
- Excessive fuel consumption

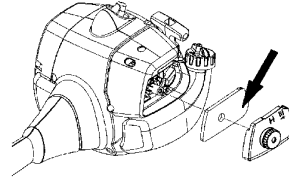

Clean the filter every 25 hours, or more regularly if conditions are exceptionally dusty.

Cleaning the air filter

Remove the air filter cover and take out the filter. Wash it clean in warm, soapy water. Rinse thoroughly. Ensure that the filter is dry before refitting it.

An air filter that has been in use for a long time cannot be cleaned completely. The filter must therefore be replaced with a new one at regular intervals. **A damaged air filter must always be replaced.**

Bevel gear (125L)



The bevel gear is filled with the right quantity of grease at the factory. However, before using the machine you should check that the bevel gear is filled three-quarters full with grease. Use HUSQVARNA special grease.

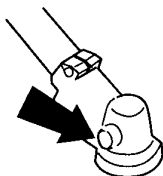

The grease in the bevel gear does not normally need to be changed except if repairs are carried out.

Maintenance schedule

Below you will find some general maintenance instructions.

Daily maintenance

- Check throttle trigger and throttle trigger lockout function.
- Check that the stop switch works correctly.
- Check that there are no fuel leaks from the engine, tank or fuel lines.
- Check that the cutter does not rotate when the engine is idling.
- Clean the outside of the machine.
- Check that the harness is not damaged.
- Check that the blade guard is not damaged or cracked.
- Replace the blade guard if it is exposed to impact or is cracked.
- A non-balanced trimmer head induces heavy vibrations that may damage the machine.
- Check that nuts and screws are tight.
- Check that the screws that hold the bevel gear are tight.
- Check that the trimmer head is tight.

Weekly maintenance

- Check the starter and starter cord.
- Clean the carburetor area.
- Clean the outside of the spark plug. Remove it and check the electrode gap. Adjust the gap to 0.024" (0.6 mm), or replace the spark plug. Use resistor spark plug Champion RCJ-6Y or equivalent.
- Clean the cooling fins on the cylinder and check that the air intake near the starter is not blocked.
- Check that the bevel gear is filled with grease up to 3/4 full. Use special grease.
- Clean the air filter.

Monthly maintenance

- Clean the fuel tank.
- Clean the outside of the carburetor and the space around it.
- Clean the fan and the area around it.
- Check fuel lines for cracks or other damage. Change if necessary.
- Change the fuel filter in fuel tank.
- Check the clutch, clutch springs and the clutch drum for wear. Replace if necessary.
- Check electrical wires and connections.
- Replace the spark plug. Use resistor spark plug Champion RCJ-6Y or equivalent.
- Change the air filter.

Trimmer Head Line Loading Instructions



1

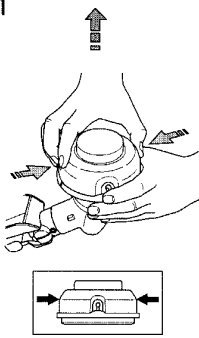

2

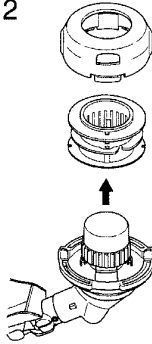

3

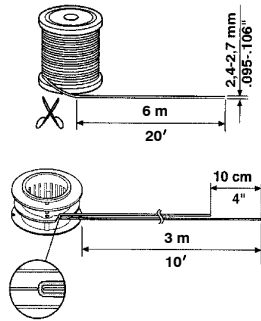

4

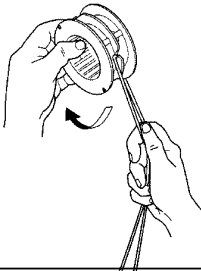

5

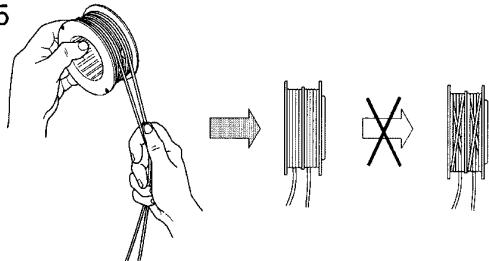

6

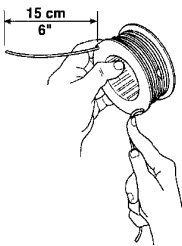

7

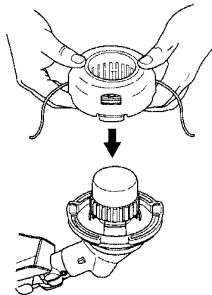

8

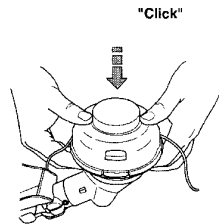

9

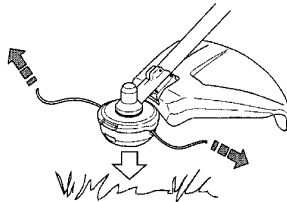

TECHNICAL DATA

Technical data

	125C	125L
Engine		
Cylinder volume, cu.in./cm ³	1.7/28	1.7/28
Cylinder bore, inch/mm	1.4/35	1.4/35
Stroke, inch/mm	1.130/28.7	1.130/28.7
Idle speed, rpm	2,800-3,200	2,800-3,200
Recommended max. speed, rpm	10,000	11,000
Speed of output shaft, rpm	8,000	8,000
Max. engine output, acc. to ISO 8893, hp/kW	1.1/0.8	1.1/0.8
Catalytic converter muffler	Yes	Yes
Speed-regulated ignition system	No	No
Ignition system		
Manufacturer/type of ignition system	Walbro/CD	Walbro/CD
Spark plug	Champion RCJ-6Y	Champion RCJ-6Y
Electrode gap, inch/mm	0.024/0.6	0.024/0.6
Fuel and lubrication system		
Manufacturer/type of carburetor	Zama	Zama
Fuel tank capacity, US pint/liter	0.85/0.4	0.85/0.4
Weight		
Weight without fuel, cutting attachment and guard, lbs/kg	10/4.4	11/4.8
Sound levels (see note 1)		
Equivalent sound pressure level at the user's ear, measured according to ANSI B175.3-1997, dB(A), min/max:	94/97	94/97
Vibration levels		
Vibration levels at handles, measured according to ANSI B175.3-1997, m/s ²		
At idle, left/right handles:	3/5	3/5
At max. speed, left/right handles:	9/8	9/8
Note 1: Equivalent noise pressure level is calculated as the time-weighted energy total for noise pressure levels under various working conditions with the following time distribution: 1/2 idle and 1/2 max. speed.		
NOTE! Noise pressure at the user's ear and vibration on the handles are measured with all the machine's approved cutting equipment fitted. The table indicates the highest and lowest values.		

Model 125C (3/8 RH arbor shaft thread)		
Approved accessories	Type	Cutting attachment guard, part. no.
Trimmer head	T25	537 33 83-03

Model 125L (M10 LH arbor shaft thread)		
Approved accessories	Type	Cutting attachment guard, part. no.
Trimmer head	T25	537 33 83-02
Plastic blades	Tricut 300 mm	531 00 38-24
J-Handle kit (to equip unit for brush blade)		503 78 17-01
*Brush blade		537 14 95-01

*For safety reasons, use ONLY when the trimmer has been fitted with the J-handle kit!

WARRANTY STATEMENT

SECTION 1: LIMITED WARRANTY
Husqvarna Forest & Garden Company
("Husqvarna") warrants Husqvarna product to the original purchaser to be free from defects in material and workmanship from the date of purchase for the "Warranty Period" of the products as set forth below:

Lifetime Warranty: Trimmer shafts, ignition coils and modules.

2 Year NON-COMMERCIAL Warranty:
Trimmers for non-commercial, non-professional, non-institutional or non-income producing use, except as herein stated. Emission control system components necessary to comply with CARB-TIER II and EPA regulations.

1 Year Warranty: All trimmers used for commercial, institutional, professional, or income producing purposes or use.

SECTION 2: HUSQVARNA'S OBLIGATIONS UNDER THE WARRANTY

Husqvarna will repair or replace defective components without charge for parts or labor if a component fails because of a defect in material or workmanship during the warranty period.

SECTION 3: ITEMS NOT COVERED BY THIS WARRANTY

The following items are not covered by this warranty:

- (1) Normal customer maintenance items which become worn through normal regular use, including, but not limited to, filters, lubricants, rewind springs, spark plugs, and starter ropes.
- (2) Natural discoloration of material due to ultraviolet light.

SECTION 4: EXCEPTIONS AND LIMITATIONS

This warranty shall be inapplicable to defects resulting from the following:

- (1) Accident, abuse, misuse, negligence and neglect, including stale fuel, dirt, abrasives, moisture, rust, corrosion, or any adverse reaction due to incorrect storage or use habits.
- (2) Failure to operate or maintain the unit in accordance with the operator's manual or instruction sheet furnished by Husqvarna.
- (3) Alterations or modifications that change the intended use of the product or affects the product's performance, operation, safety, or durability, or causes the product to fail to comply with any applicable laws.
- (4) Additional damage to parts or components due to continued use occurring after any of the above.

REPAIR OR REPLACEMENT AS PROVIDED UNDER THIS WARRANTY IS THE EXCLUSIVE REMEDY OF THE PURCHASER. HUSQVARNA SHALL NOT BE LIABLE FOR ANY INCIDENTAL OR CONSEQUENTIAL DAMAGES FOR BREACH OF ANY EXPRESS OR IMPLIED WARRANTY ON

THESE PRODUCTS EXCEPT TO THE EXTENT PROHIBITED BY APPLICABLE LAW. ANY IMPLIED WARRANTY OR MERCHANTABILITY OR FITNESS FOR A PARTICULAR PURPOSE ON THESE PRODUCTS IS LIMITED IN DURATION TO THE WARRANTY PERIOD AS DEFINED IN THE LIMITED WARRANTY STATEMENT. HUSQVARNA RESERVES THE RIGHT TO CHANGE OR IMPROVE THE DESIGN OF THE PRODUCT WITHOUT NOTICE, AND DOES NOT ASSUME OBLIGATION TO UPDATE PREVIOUSLY MANUFACTURED PRODUCTS.

Some states do not allow the exclusion of incidental or consequential damages, or limitations on how long an implied warranty lasts, so the above limitations or exclusions may not apply to you. This warranty gives you specific legal rights, and you may also have other rights which vary from state to state.

SECTION 5: CUSTOMER RESPONSIBILITIES

The product must exhibit reasonable care, maintenance, operation, storage and general upkeep as written in the maintenance section of the operator's manual. Should an operational problem or failure occur, the product should not be used, but delivered as is to an authorized Husqvarna dealer for evaluation. Proof of purchase, as explained in Section 6, rests solely with the customer.

SECTION 6: PROCEDURE TO OBTAIN WARRANTY CONSIDERATION

It is the Owner's and Dealer's responsibility to make certain that the Warranty Registration Card is properly filled out and mailed to Husqvarna Forest & Garden Company. This card should be mailed within ten (10) days from the date of purchase in order to confirm the warranty and to facilitate post-sale service. Proof of purchase must be presented to the authorized Husqvarna dealer in order to obtain warranty service. This proof must include date purchased, model number, serial number, and complete name and address of the selling dealer. To obtain the benefit of this warranty, the product believed to be defective must be delivered to an authorized Husqvarna dealer in a timely manner, no later than thirty (30) days from date of the operational problem or failure. The product must be delivered at the owner's expense. Pick-up and delivery charges are not covered by this warranty. An authorized Husqvarna dealer can be normally located through the "Yellow Pages" of the local telephone directory or by calling 1-800-HUSKY62 for a dealer in your area.

 **Husqvarna**

7349 Statesville Road
CHARLOTTE, NC 28269

U.S. EPA / CALIFORNIA / ENVIRONMENT CANADA EMISSION CONTROL WARRANTY STATEMENT

YOUR WARRANTY RIGHTS AND OBLIGATIONS:

The U.S. Environmental Protection Agency, California Air Resources Board, Environment Canada and HUSQVARNA are pleased to explain the emissions control system warranty on your year 2005 and later small off-road engine. In California, all small off-road engines must be designed, built, and equipped to meet the State's stringent anti-smog standards. HUSQVARNA must warrant the emission control system on your small off-road engine for the periods of time listed below provided there has been no abuse, neglect, or improper maintenance of your small off-road engine. Your emission control system includes parts such as the carburetor and the ignition system. Where a warrantable condition exists, HUSQVARNA will repair your small off-road engine at no cost to you. Expenses covered under warranty include diagnosis, parts and labor.

MANUFACTURER'S WARRANTY COVERAGE:

If any emissions related part on your engine (as listed under Emissions Control Warranty Parts List) is defective or a defect in the materials or workmanship of the engine causes the failure of such an emission related part, the part will be repaired or replaced by HUSQVARNA.

OWNER'S WARRANTY RESPONSIBILITIES:

As the small off-road engine owner, you are responsible for the performance of the required maintenance listed in your operator's manual. HUSQVARNA recommends that you retain all receipts covering maintenance on your small off-road engine, but HUSQVARNA cannot deny warranty solely for the lack of receipts or for your failure to ensure the performance of all scheduled maintenance. As the small off-road engine owner, you should be aware that HUSQVARNA may deny you warranty coverage if your small off-road engine or a part of it has failed due to abuse, neglect, improper maintenance, unapproved modifications, or the use of parts not made or approved by the original equipment manufacturer. You are responsible for presenting your small off-road engine to a HUSQVARNA authorized repair center as soon as a problem exists. Warranty repairs should be completed in a reasonable amount of time, not to exceed 30 days. If you have any questions regarding your warranty rights and responsibilities, you should contact your nearest authorized service center or call HUSQVARNA at 1-800-487-5963.

WARRANTY COMMENCEMENT DATE:

The warranty period begins on the date the small off-road engine is purchased.

LENGTH OF COVERAGE:

This warranty shall be for a period of two years from the initial date of purchase.

WHAT IS COVERED: REPAIR OR REPLACEMENT OF PARTS.

Repair or replacement of any warranted part will be performed at no charge to the owner at an approved HUSQVARNA servicing center. If you have any questions regarding your warranty rights and responsibilities, you should contact your nearest authorized service center or call HUSQVARNA at 1-800-487-5963.

WARRANTY PERIOD:

Any warranted part which is not scheduled for replacement as required maintenance, or which is scheduled only for regular inspection to the effect of "repair or replace as necessary" shall be warranted for 2 years. Any warranted part which is scheduled for replacement as required maintenance shall be warranted for the period of time up to the first scheduled replacement point for that part.

DIAGNOSIS:

The owner shall not be charged for diagnostic labor which leads to the determination that a warranted part is defective if the diagnostic work is performed at an approved HUSQVARNA servicing center.

CONSEQUENTIAL DAMAGES:

HUSQVARNA may be liable for damages to other engine components caused by the failure of a warranted part still under warranty.

WHAT IS NOT COVERED:

All failures caused by abuse, neglect, or improper maintenance are not covered.

ADD-ON OR MODIFIED PARTS:

The use of add-on or modified parts can be grounds for disallowing a warranty claim. HUSQVARNA is not liable to cover failures of warranted parts caused by the use of add-on or modified parts.

HOW TO FILE A CLAIM:

If you have any questions regarding your warranty rights and responsibilities, you should contact your nearest authorized service center or call HUSQVARNA at 1-800-487-5963.

WHERE TO GET WARRANTY SERVICE:

Warranty services or repairs shall be provided at all HUSQVARNA service centers. Call 1-800-487-5963.

U.S. EPA / CALIFORNIA / ENVIRONMENT CANADA EMISSION CONTROL WARRANTY STATEMENT

MAINTENANCE, REPLACEMENT AND REPAIR OF EMISSION RE- LATED PARTS:

Any HUSQVARNA approved replacement part used in the performance of any warranty maintenance or repair on emission related parts will be provided without charge to the owner if the part is under warranty.

EMISSION CONTROL WARRANTY PARTS LIST:

Carburetor, Ignition System: Spark Plug (covered up to maintenance schedule), Ignition Module.

MAINTENANCE STATEMENT:

The owner is responsible for the performance of all required maintenance as defined in the operator's manual.

This engine is certified to be emissions compliant for the following use:

- Moderate (50 hours)
- Intermediate (125 hours)
- Extended (300 hours)



7349 Statesville Road
CHARLOTTE, NC 28269

For customer assistance call:

1-800-448-7543

or contact us at our website:

www.usa.husqvarna.com

Free Manuals Download Website

<http://myh66.com>

<http://usermanuals.us>

<http://www.somanuals.com>

<http://www.4manuals.cc>

<http://www.manual-lib.com>

<http://www.404manual.com>

<http://www.luxmanual.com>

<http://aubethermostatmanual.com>

Golf course search by state

<http://golfingnear.com>

Email search by domain

<http://emailbydomain.com>

Auto manuals search

<http://auto.somanuals.com>

TV manuals search

<http://tv.somanuals.com>