

ida ReRouter

Installation & Operator's Guide

Doc. no 60276 Revision 00

WARNING:

This equipment generates, uses, and can radiate radio frequency energy and if not installed and used in accordance with the instruction manual, may cause interference to radio communications. It has been tested and found to comply with the limits for a Class A computing device pursuant to Subpart B of Part 15 of FCC Rules, which are designed to provide reasonable protection against such interference when operated in a commercial environment. Operation of this equipment in a residential area is likely to cause interference in which case the user at his own expense will be required to take whatever measures may be required to correct the interference.

EMC directive:

This product observes the rules and regulations of the EMC directive. If so required, a declaration of conformity in local language stipulating the applied rules and regulations can be obtained.

Trademarks:

Company and product names mentioned in this datasheet are trademarks or registered trademarks of their respective owners. i-data international a-s cannot be held responsible for any technical or typographical errors and reserves the right to make changes to products and documentation without prior notification.

Document No.: D60276-00

© Copyright i-data international a-s 1997

MAIN OFFICE:

i-data international a-s

Vadstrupvej 35-43
DK-2880 Bagsvaerd
Denmark

Telephone: +45 44 36 60 00
Telefax: +45 44 36 61 11

E-mail: [i-data @ i-data.com](mailto:i-data@i-data.com)

WWW: <http://www.i-data.com>

i-data Denmark

Vadstrupvej 35
DK-2880 Bagsvaerd
Denmark

Telephone: +45 44 44 77 50
Telefax: +45 44 44 85 50

i-data Sweden

Datavägen 21
S-43600 Askim
Sweden

Telephone: + 00 46 31 680710
Telefax: + 00 46 31 682670

i-data UK Ltd.

Unit 3, Cartel Business Centre
Stroudley Road
Basingstoke, Hants RG24 8FW
United Kingdom

Telephone: + 00 44 1 256 460033
Telefax: + 00 44 1 256 460066

i-data France

Parc de Haute Technologie
2, rue Alexis de ocqueville
92183 Antony Cedex
France

Telephone: + 00 33 1 46114340
Telefax: + 00 33 1 46114341

i-data, Inc.

250-V Executive Drive
Edgewood
New York 11717
U.S.A.

Telephone: (516) 243-6600
Telefax: (516) 243-6500

i-data Australia Pty. Ltd.

14, Gipps Street
Collingwood, Victoria 3066
Australia

Telephone: +00 61 3 4195877
Telefax: +00 61 3 4195610

Preface

January 1997

This manual covers the installation and configuration of the *ida ReRouter*.

The *ida ReRouter* is a transaction program designed to take Host IPDS print using the LU 6.2 protocol and convert it to print using a bi-directional TCP/IP protocol. The program operates under OS/2 2.0 or higher. For a broader description of the *ida ReRouter*, see chapter 1: "Introduction".

The user must have basic knowledge of Communications Manager, SNA, OS/2 and TCP/IP related environments.

Prerequisite Manuals

"IBM Transmission Control Protocol / Internet Protocol Version 2 for OS/2, Installation and Administration, SC31-6075."

"Communications Manager/2 V1", Configuration Guide
Order no. SC31-61-71-00

Related Manuals

For operation of the *ida ReRouter* on a remote device, you are also to consult the documentation for that particular remote device.

Token Ring	Ethernet
<i>ida 913-03 Token Ring</i> LAN Brick Installation Guide Doc. no. D11068/D61068	<i>ida 913-04 Ethernet</i> LAN Brick Installation Guide Doc. no. D11069/D61069
<i>i-data 7913-03 IPDS</i> Token Ring LAN Attachment Installation Guide Doc. no. D11072/D61062	<i>i-data 7913-04 IPDS</i> Ethernet LAN Attachment Installation Guide Doc. no. D11071/D61071
<i>ida PS x3</i> Installation and Operator's Guide Doc. no. D10325/D60325	<i>ida PS x4</i> Installation and Operator's Guide Doc. no. D10326/D60326

For details on host configuration, refer to these manuals:
ida PSS MVS, Product Installation Guide, doc. no. D6052
ida PSS VM, Product Installation Guide, doc. no. D6055

Table of Contents

1. Introduction	7
1.1 What is the <i>ida ReRouter</i> ?	7
1.2 Product Features	9
2. Items Supplied with <i>ida ReRouter</i>	10
3. Product Requirements	11
3.1 Host System Requirements	11
3.2 Personal Computer Requirements	11
4. Installation and Setup of <i>ida ReRouter</i>	12
4.1 Installation of <i>ida ReRouter</i>	12
4.2 Setup of <i>ida ReRouter</i>	14
4.2.1 Defining a new route	18
4.2.2 Additional routes	21
4.2.3 Changing a route	21
4.2.4 Deleting a route	21
4.3 Keep Alive Function	22
4.3.1 Support for KeepAlive to OS/2	22
4.3.2 TCP/IP KeepAlive configuration on OS/2	23
5. Configuration of S/370 Networks	24
5.1 Configuration Examples for MVS and VM	24
5.1.1 PSF/MVS printer definition and startup procedure	24
5.1.2 PSF/VM PDM definition	26
5.1.3 PSS/MVS printer definition and startup procedure	27
5.1.4 PSS/VM PDM definition	28
5.1.5 PSS printer profile using SNA and TCP/IP attachment	30
5.1.6 Host VTAM definition	31
6. Configuration of AS/400 Networks	33
6.1 Creating APPC device description	33
6.2 Creating Printer Device Description	34
6.3 Updating APPN Remote Location List	35
6.4 Sample Controller Definition	37
7. Workstation Configuration	38
7.1 Communications Manager/2 for S/370-390 and AS/400	38
7.1.1 Changing configuration file	39
7.1.2 S/370 Network Configuration Worksheet	47
7.1.3 AS/400 Network Configuration Worksheet	49
7.1.4 Explanation to Configuration Worksheets	53
7.2 LAPS	57
7.3 TCP/IP	57

8. Testing Connection to Remote Device	59
8.1 PING Function	59
8.2 Log Files	61
9. Problem Determination	62
9.1 Error Syntax	62
9.2 Trace	68
10. List of Abbreviations	69
Appendix A: Keyword Definitions	70
Appendix B: Fill-In Configuration Worksheet	73
Appendix C: i-data Products	77

1. Introduction

This chapter provides a brief introductory description of the *ida ReRouter*. Chapter 4 describes the installation and setup in details.

1.1 What is the *ida ReRouter*?

The *ida ReRouter* is a transaction program which is able to take Host print using the LU 6.2 protocol and pass it to a bi-directional TCP/IP (Transmission Control Protocol / Internet Protocol) protocol on any one of the supported products stated in section 2.2. "Product Features".

The configuration in the following illustrates the routing of Host data using the *ida ReRouter*. See the explanation to the configuration below the figure.

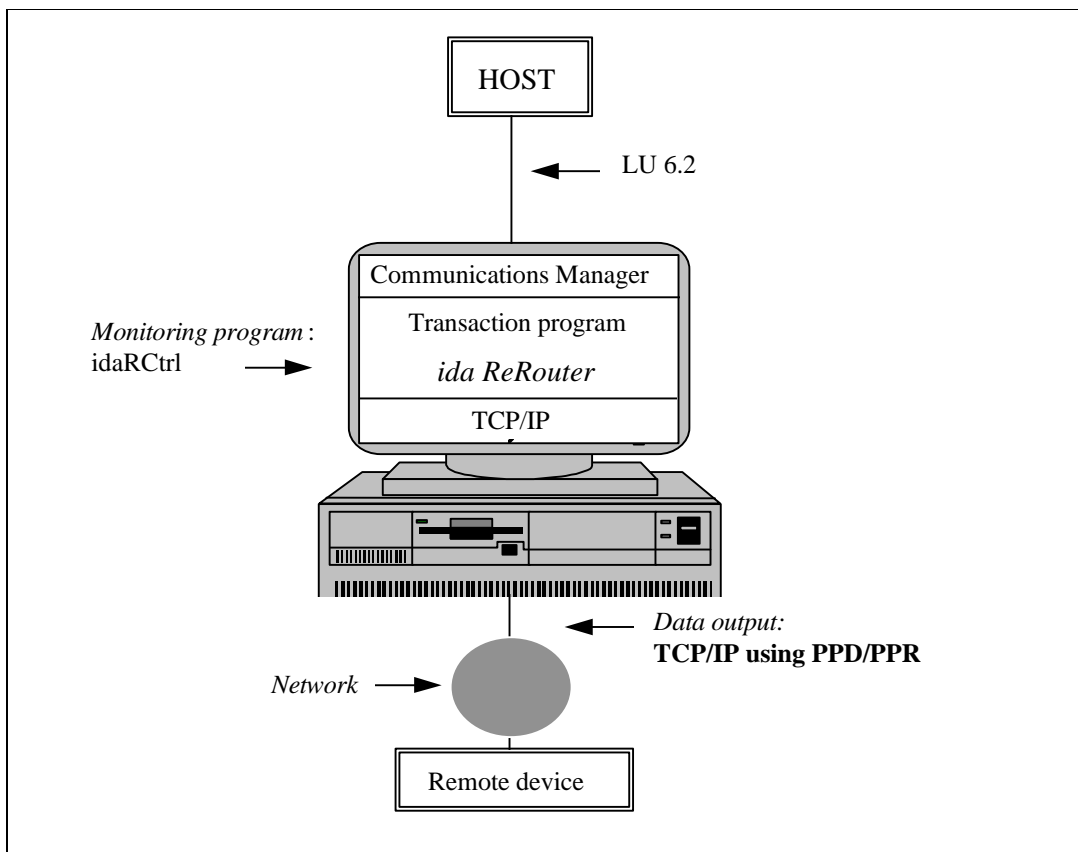

Fig. 1.1: Printing host data using *ida ReRouter*

When the host IPDS print (LU 6.2 data) is received by Communications Manager/2, it is sent via the defined transaction program profile to the *ida ReRouter*.

From the *ida ReRouter*, printer data will be passed transparently through the TCP/IP protocol and repacked into the format of a bi-directional TCP/IP protocol called "PPR/PPD" (*Page Printer RemotePage Printer Daemon*).

In the following is illustrated how the *ida ReRouter* could be applied. See *Fig. 1.2: "ida ReRouter in Token Ring Environment"* and *Fig. 1.3: "ida ReRouter in Ethernet Environment"*.

ida ReRouter in a Token Ring environment:

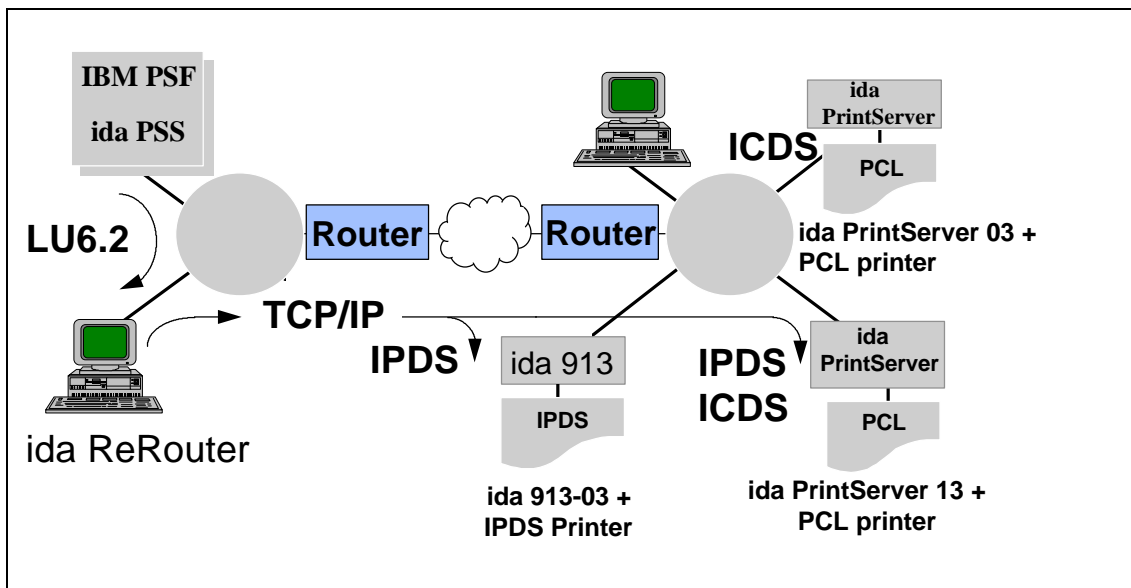

Fig. 1.2: ida ReRouter in Token Ring environment

ida ReRouter in an Ethernet environment:

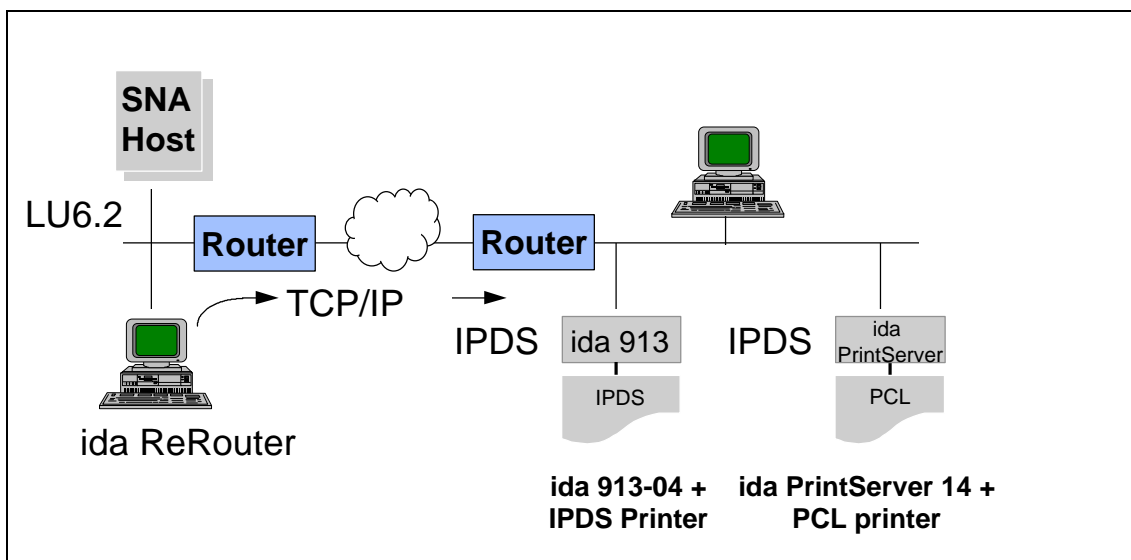

Fig. 1.3: ida ReRouter in Ethernet environment

ida ReRouter

The *ida ReRouter* consists of two main programs:

- **idaRoute** (LU 6.2 to TCP/IP ReRouter for OS/2)
The function of the *idaRoute* is to act as link between the Host (SNA environment) and the TCP/IP protocol. In this way the Host will assume that communication with an LU 6.2 device has been established. Based on the defined LU Alias (which *must* be the equivalent of the one defined in Communications Manager/2), the *idaRoute* sends print data and printer information transparently through the TCP/IP network.
- **idaRCtrl**
Control program for *idaRoute* with two functions:
 - setting up the routes
 - showing the status of the defined routes (active/inactive)

Status of the defined route names will appear from the status field in the *idaRoute* main screen. (See the *idaRoute* main screen on page 15).

1.2 Product Features

The *ida ReRouter* provides the following features:

- The *ida ReRouter* transaction program performs direct host print from e.g. S/370-390 or AS/400 to the following products:

<ul style="list-style-type: none">- ida PrintServer 13- ida PrintServer 14- ida RPPC with TCP/IP for <i>Sinix</i>	With connections to PCL 4/5 printers.
<ul style="list-style-type: none">- ida 913-03 Token Ring LAN Brick- ida 913-04 Ethernet LAN Brick- i-data 7913-03 Token Ring LAN Attachment- i-data 7913-04 Ethernet LAN Attachment	With connections to IPDS Laser / Matrix printers for Coax or Twinax environments.
- **Host applications:**
The *ida ReRouter* supports a number of host applications. For details see section 3.1 "Host System Requirements".
- Supports LAN attached TCP/IP products
- Supports up to 32 sessions

2. Items Supplied with *ida ReRouter*

The following items are supplied with the *ida ReRouter*.

-  • 3.5" diskette containing among others a setup file and an informative file - readme.txt.
..... and other files used for setting up and configuring the *ida ReRouter*.

- Product documentation:
-  ✓ “Plug and play” documentation :
ida ReRouter
Quick Guide:
D10276

-  ✓ Electronic documentation (for more advanced use):
ida ReRouter
Installation and Operator's Guide
D60276

3. Product Requirements

3.1 Host System Requirements

- **Mainframe**
 - PSF/VM 2.1 or higher
 - PSF/MVS 2.1 or higher
 - PSF/VSE 2.1 or higher
- **AS/400**
 - OS/400, version 2.2 or higher
 - PSF/400 for OS/400, version 3.1 or higher

3.2 Personal Computer Requirements

Hardware:

- LAN attached OS/2 workstation

Software:

- OS/2 2.0 or higher
- Communications Manager ES, version 1.0 or higher
or
Communications Manager/2, version 1.0 or higher
- TCP/IP 2.0 or higher for OS/2 (Base Kit) with CSD UN64092
- LAPS (LAN Adapter Protocol Support), with CSD WRU7045 or higher.
(must have TCP/IP support)

To verify the CSD level, you enter the command SYSLEVEL at an OS/2 command prompt. Press ENTER to scroll through the display until you see the entry for "TCP/IP BASE FOR OS/2 AND 2.1" showing the current CSD level.

4. Installation and Setup of *ida ReRouter*

This chapter describes the installation and configuration of the *ida ReRouter*.

4.1 Installation of *ida ReRouter*

1. Insert the *ida ReRouter* installation diskette into drive A.
2. Type: **A: setup**
3. Now the following screen will appear:

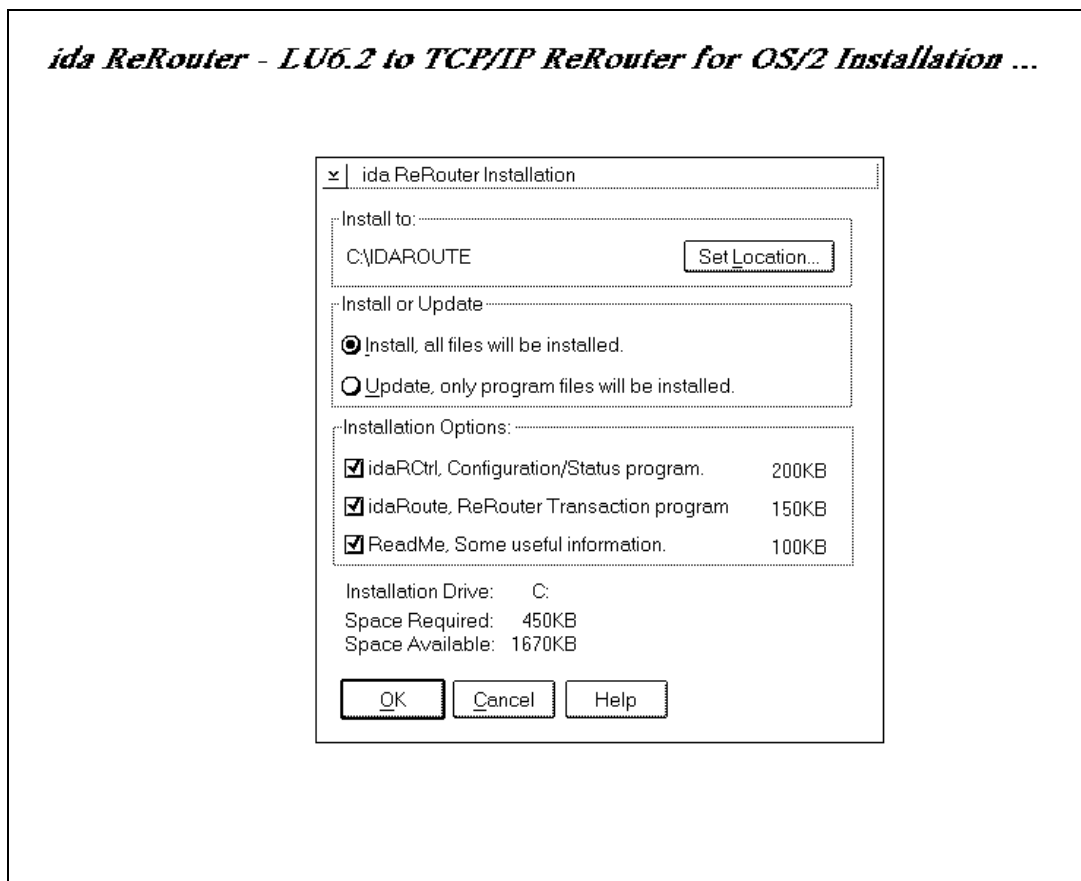

4. Set the location of the program to the disk and directory of choice
5. Select the field "**Install**" if all files are to be installed (This will create folders, icons, programs, etc).

(If the *ida ReRouter* is to be upgraded, select "Update" for only the program files to be installed.)

6. Select/De-select the installation options according to needs and requirements.

When the installation entries have been made, information as to program location and space required/available will appear at the bottom of the screen.

7. Click on "**OK**" to confirm the installation and see this screen:

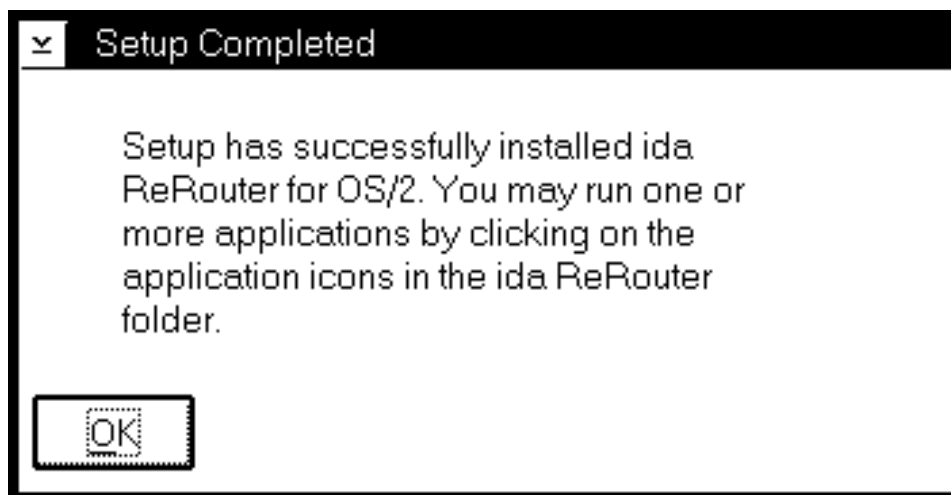

Now the folder "idaRoute" will be created and you may proceed with the setup of the *ida ReRouter*. See section 4.2: "Setup of *ida ReRouter*".

4.2 Setup of *ida ReRouter*

After having completed the installation, the OS/2 desktop will create a folder called "*ida ReRouter*". This folder contains two objects:

- the configuration program
- a ReadMe file

1. Click on the "idaReRouter" folder.

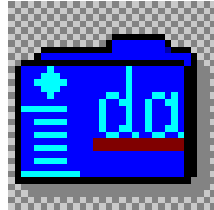

ida ReRouter

2. Click on the idaRCtrl icon.



idaRCtrl

The following screen will now appear:

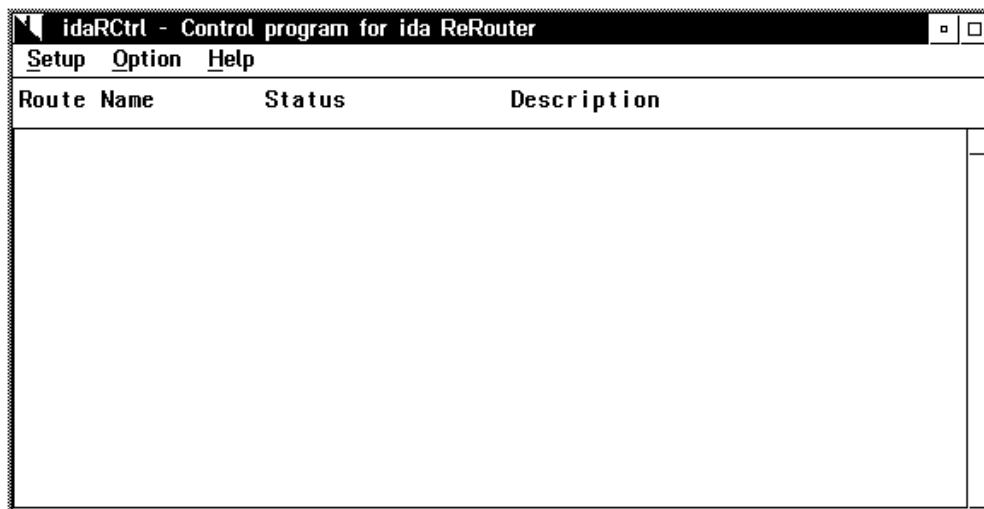

Route name

This is the user defined Alias for a particular route.

Status

The status panel provides information on the status of each Route session to the remote printer.

The status messages are:

INACTIVE
ACTIVATING
ACTIVE
DEACTIVATING
INTERVENTION REQUIRED

Together with the above status messages, there will be a complete LOG of all events in the LOG file associated with each Route. See section 8.2: "Log Files" for additional information

Description

This menu gives a brief description of the defined route.

To setup and operate with routes in the *ida ReRouter*, click on "**Setup**", and the following screen will appear.

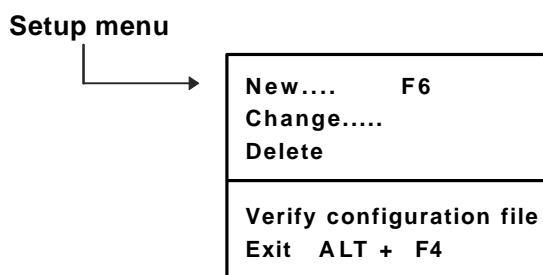

New

The defining of new routes is described in details in section 4.2.1: "Defining a new route". To add more routes, see section 4.2.2: "Additional routes".

Change

Changing an existing route is described in section 4.2.3: "Changing a route".

Delete

Deleting a route is described in section 4.2.4: "Deleting a route".

Verify

Verifying the settings is only necessary to use when the idaRoute.ini file has been modified manually without using the idaRCtrl.

In case of an error situation, a verification log is created containing all necessary information.

3. If you click on the sub-menu "**Options**", you will be provided with the following options:
 - DeActivate Route
 - Refresh
 - View Log

Option
menu



DeActivate Route

NOTE: This entry field should be used only with great care.

The request for deactivating a route derives from the OS/2 system. The remote printer device /queue will be stopped on the Host system and active jobs will be interrupted.

Refresh

This entry field will refresh the system and include the latest changes. Automatic refresh interval of 30 seconds.

View Log

This field is used for viewing an ASCII log file.

4. For help click the sub menu "**Help**". This contains the following entry fields:
- Help index
 - General help
 - Using help

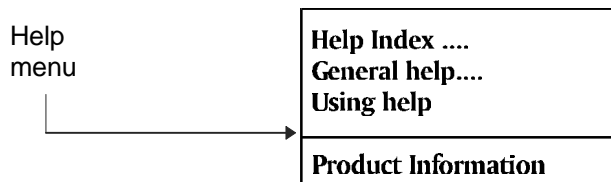

Product Information

The field "Product Information" provides information on the latest firmware no. This information is needed when contacting your point of purchase in case of an error situation.

4.2.1 Defining a new route

1. To setup the *ida ReRouter*, click on "**Setup**" in the setup dialog screen (or select: "ALT_S"). See the screen on page 16.
2. Click on "**New**" to define a new route. The following screen will appear:

Define a new route →

Route information setup

Route Name:

Description:

LU-Alias:

IP-Address [remote] :

Port No. [remote] :

Connect TimeOut [sec.] :

Option:

Trace Class:

3. Enter **Route name** (mandatory)
Route name is the user defined Alias for a particular route.
Range: Alphanumerical string (A-Z, a-z, 0-9), no white spaces.
Max. 15 characters
Default: None
4. Enter **Description**
Short description of the defined route.
Range: String with ASCII characters
Max. 30 characters
Default. None
5. Enter **LU Alias** (case sensitive)
Logical unit used for the LU 6.2 connection.
The LU Alias must be limited to 8 characters.

NOTE: LU Alias must match the LU Alias defined in Communications Manager

If the LU Alias is not defined, the idaRoute will terminate and write to the log file.

6. Enter **IP Address** (in Decimal Dot notation)

NOTE: Must match the device (e.g. *ida 913-03 / ida 913 04*) being communicated with

Range: 0.0.0.0 - 255.255.255.255.

Default: None

7. Select **Port No.**

NOTE: This is default **5001** for all IPDS applications

Range: Decimal value 0-9999

Default: 5001 *)

*): Remote devices supporting more than one output port may use port no. 5002. For details you are referred to the manual for the remote device being connected to.

8. Enter **Connect Timeout**

This entry field will specify the time the idaRoute will wait after having initiated a connection till the idaRoute receives a response from the remote TCP/IP attached device.

Range: 0-9999 seconds

Default: **30** seconds.

9. The field **Trace Class** is used for debugging purposes only.
For additional information, see chapter 9: "Problem Determination"

10. Click on "**OK**" to verify the configuration.

When the all the setup entries have been made and verified, the *ida ReRouter* will create a configuration file (idaRoute.ini file). See the sample configuration file below.

```
. *****  
,  
, *                               *  
, *           idaRoute.ini         *  
, * Configuration file for the i-data LU 6.2 to TCP/IP ReRouter for OS/2 2.x *  
, *                               *  
, *****  
,  
,  
,  
DEFINE_ROUTE  
  ROUTE_NAME PSF-AS400  
  DESCRIPTION PSF-AS400 to ida 913-03  
  LUALIAS RER1  
  IPADDRESS 192.0.0.19  
  PORTNO 5001  
  CONTIMEOUT 30  
  TRACE 0  
END  
;  
DEFINE_ROUTE  
  ROUTE_NAME PSF-S390  
  DESCRIPTION PSF/VM-MVS to ida 913-03  
  LUALIAS SNCEP0  
  IPADDRESS 192.0.0.20  
  PORTNO 5001  
  CONTIMEOUT 30  
  TRACE 0  
END  
;  
DEFINE_ROUTE  
  ROUTE_NAME PSF-VM2  
  DESCRIPTION PSF-VM to ida PrintServer13  
  LUALIAS SNCEP1  
  IPADDRESS 192.1.8.1  
  PORTNO 5001  
  CONTIMEOUT 30  
  TRACE 0
```

NOTE. If setup is changed manually in the idaRoute.ini file, there will be *no* validation of the changes made. Validation must be made in the configuration program.

4.2.2 Additional routes

More routes may be added by clicking on "Setup" and then "New". Follow the setup procedures in the steps 3-10 above.

NOTE: No two *route names* and *LU Aliases* may be identical.

For each route defined, the idaRoute will be loaded implying that it will be running in multiple instances. The OS/2 system puts a limit on the defined routes. However, 32 routes are able to run simultaneously.

4.2.3 Changing a route

1. To change a route you either double click on the route to be changed or click on "Setup" and then on "Change".
2. Make the necessary / required changes and click on " **OK**".

4.2.4 Deleting a route

1. Select the route to be deleted and click on "OK".
2. If you need to delete a route, click on "Setup" and then on "Delete".
3. Confirm the deleting of the route.

NOTE: The route must be de-activated before it can be deleted.

4.3 Keep Alive Function

The KEEPALIVE feature is a monitor function to check the connection between the transaction program (i.e. the *ida ReRouter* program) and the printer. The monitoring of the connection is done at defined intervals.

4.3.1 Support for KeepAlive to OS/2

The TCP/IP components for OS/2 offer network attachment for printers. However, these TCP/IP components do not always detect connection failures if a point-to-point session between the OS/2 machine and the device has failed (e.g. in connection with a printer being abruptly powered off). This may result in serious problems if the printers comprise IPDS printers in sessions with PSF/2 or PSF/6000.

Now, support for the TCP KEEPALIVE facility has been added to the TCP/IP components for OS/2 to detect all communication failures. The PSF/6000 or PSF/2 direct TCP to send a KEEPALIVE transmission on a TCP connection remaining inactive for an extended period. If the KEEPALIVE transmission is not acknowledged, the TCP assumes that the connection partner has been lost and subsequently reports a failure to the PSF/6000 or PSF/2.

The frequency of these transmissions depends upon the configuration of the TCP/IP in the OS/2 environments. On OS/2, the default values are two hours or more. Both platforms, however, allow the frequency of KEEPALIVE transmissions to be adjusted. These values apply to all TCP applications that request KEEPALIVE transmissions.

In the following, you are provided with instructions for using the KEEPALIVE support facility added to the TCP/IP components for OS/2.

4.3.2 TCP/IP KeepAlive configuration on OS/2

- OS/2 2.0 with APAR IR28716 fix must be installed.
- TCP/IP 2.0 with CSD UN64092 or later must be installed.
- The TCP/IP "inetcfg" command can be used to configure the "KEEPALIVE" parameter.

```
inetcfg KEEPALIVE=nnn
```

where nnn is the number of minutes a TCP connection must remain inactive before TCP generates a KEEPALIVE transmission for an application that requests them.
The default is 120 minutes.

The inetcfg command must be run each time the OS/2 system is started. Adding the inetcfg command to \tcip\bin\tcpstart.cmd is a convenient way to automate this step.

For example, adding

```
inetcfg KEEPALIVE=4
```

to \tcip\bin\tcpstart.cmd causes TCP to send a KEEPALIVE transmission if a TCP connection has been inactive for 4 minutes and the application requested KEEPALIVE transmissions, as OS/2 now does. OS/2 recommends this TCP configuration setting for customers who use TCP/IP-attached printers and the device.

If the KEEPALIVE transmission is not acknowledged, the TCP will attempt to re-connect up to 9 times. The interval between these attempts is fixed but short.

5. Configuration of S/370 Networks

This chapter will provide you with configuration instructions for the S/370-390 networks with PSF.

5.1 Configuration Examples for MVS and VM

5.1.1 PSF/MVS printer definition and startup procedure

```
/★ From the system PARMLIB  
PRT08,CLASS=A,SEP,NOMARK,DRAIN,MODE=FSS,FSS=WRITER08,  
PRMODE=(LINE,PAGE),UCS=0
```

Example of PSF/MVS JES2 printer definition

NOTE: The SEP parameter must be used if PTF number = UY94833 for environment 102 is not installed.

```

//PSF      PROC
//IDAFSS1  EXEC PGM=APSPPIEP.REGION=4M
//JOBHDR   OUTPUT PAGEDEF=SEP300, / * JOB HEADER PAGEDEF * /
//         FORMDEF=SEP300, / * JOB HEADER FORMDEF * /
//         CHARS=GT15 / * JOB HEADER FONT * /
//JOBTLR   OUTPUT PAGEDEF=SEP300, / * JOB TRAILER PAGEDEF * /
//         FORMDEF=SEP301, / * JOB TRAILER FORMDEF * /
//         CHARS=GT15 / * JOB TRAILER FONT * /
//DSHDR    OUTPUT PAGEDEF=A06462, / * DS HEADER PAGEDEF * /
//         FORMDEF=A10110, / * JOB HEADER FORMDEF * /
//         CHARS=GT15 / * JOB HEADER FONT * /
//MSGDS    OUTPUT PAGEDEF=A06462, / * MESSAGE DATASET PAGEDEF * /
//         FORMDEF=A10110, / * MESSAGE DATASET FORMDEF * /
//         CHARS=GT15 / * MESSAGE DATASET FONT * /
//*****
//FONT01   DD DISP=SHR,DSN=IDA.FONTLIB
//PSEG01   DD DISP=SHR,DSN=IDA.PSEGLIB
//OLAY01   DD DISP=SHR,DSN=IDA.OVLYLIB
//PDEF01   DD DISP=SHR,DSN=IDA.PDEFLIB
//FDEF01   DD DISP=SHR,DSN=IDA.FDEPLIB
//*****
//PRT08    CNTL
//PRT08    PRINTDEV FONTDD=* .FONT01, /* FONTLIBRARY DD */
//         OBLYDD=* .OLAY01, /* OVERLAY LIBRARY DD */
//         PSEGDD=* .PSEG01, /* SEGMENT LIBRARY DD */
//         PDEFDD=* .PDEF01, /* PAGEDEF LIBRARY DD */
//         FDEFDD=* .FDEF01, /* FORMDEF LIBRARY DD */
//         JOBHDR=* .JOBHDR, /* JOB HEADERSEP.OUTPUT */
//         JOBTRLR=* .JOBTLR, /* JOBTRAILER SEP. OUTPUT */
//         DSHDR=* .DSHDR, /* DATASET HEADER SEPARATOR */
//         MESSAGE=* .MSGDS, /* MESSAGE DATA SET OUTPUT */
//         PAGEDEF=A4L8 /* DEVICE PAGEDEF DEFAULT */
//         FORMDEF=A4, /* DEVICE FORMDEF DEFAULT */
//         CHARS=(GT12, /* DEVICE */
//         GT12,GT12,GT12), /* DEFAULT FONT SET */
//         DATAK=UNBLOCK, /* ACCUMULATE DATASET MES, */
//         PIMSG=(YES,999), /* ACCUMULATE DATASET MES, */
//         TRACE=NO, /* CREATE INTERNAL TRACE */
//         FAILURE=WCONNECT, /* PSF ACTION ON PRT FAILURE */
//         TIMEOUT=REDRIVE, /* PSF ACTION ON TIMEOUT */
//         DISINTV=0, /* DISC.INTERVAL IN SECONDS */
//         APPLID=PSFAPP11, /* VTAM APPL.PGM MODE NAME. */
//         LOGMODE=IBM3820T, /* VTAM LOGON MODE TAB. ENT. */
//         MGMTMODE=OUTAVAIL, /*
//         LUNAME=IDSNCEP0 /* VTAM LOGICAL UNIT NAME */
//PRT08    ENDCNTL

```

Example of PSF&MVS startup procedure

NOTE: *OVLYDD, PSEGDD, PDEFDD and FDEFDD*

The Overlay, Segment, Pagedef. and Formdef. library statements should match the IPDS emulation selected on the device to be communicated with.

DISINTV

To avoid unnecessary stopping/starting of session, the DISINTV (Disconnect Interval Timer) should be set to 0.

5.1.2 PSF/VM PDM definition

```
*****  
LUNAME IDSNCEP0  
LOGMODE IBM3820T  
*****  
ALLQUERY YES  
APPLID PSFAPP11  
MANUAL  
CLASS A  
COMPMSG YES  
CONVERT 1  
DEST SNCEP0  
SHARPE YES  
DISINTV 0  
FAILURE WCONNECT  
FORM *  
HEADFEDF F1SGRP4 FDEF38PP  
HEADFEDF P1SGRP4 PDEF38PP  
ITRACE OFF  
MGMTMODE OUTAVAIL  
SIZE 256  
TAILFDEF F1SGRP4 FDEF38PP  
TAILPDEF P1SGRP4 PDEF38PP  
TIMEOUT REDRIVE
```

Example of PSF/VM PDM definitions

5.1.3 PSS/MVS printer definition and startup procedure

```
/* From the system PARMLIB
PRT410,CLASS=A,DRAIN,MODE=FSS,FSS=PSS4,
    PRMODE=(LINE, PAGE),UCS=0,WS=(W,R,Q/F)

PRT411,CLASS=A,DRAIN,MODE=FSS,FSS=PSS4,
    PRMODE=(LINE, PAGE),UCS=0,WS=(W,R,Q/F)
```

Example of PSS/MVS JES2 printer definition

```
//PSS4      PROC
//PSS4      EXEC PGM=IDAPSS4,TIME=1440,REGION=4M
//STEPLIB   DD DISP=SHR,DSN=USER.LINKLIB
//*-----
//SYSPROF   DD DISP=SHR,DSN=USER.PROCLIB(PROG4)
//SYSUDUMP  DD SYSOUT=E
//LOG1      DD SYSOUT=E
//LOG2      DD SYSOUT=E
//LOG3      DD SYSOUT=E
//*-----
//FONT300   DD DISP=SHR,DSN=IDA.FONTLIB
//*-----
//FONTTFM   DD DISP=SHR,DSN=IDA.FONTTFM
//*-----
//PDEF38PP  DD DISP=SHR,DSN=IDA.PDEFLIB
//*-----
//FDEF38PP  DD DISP=SHR,DSN=IDA.FDEFLIB
//*-----
//OVL38PP   DD DISP=SHR,DSN=IDA.OVERLIB
//*-----
//PSEG38PP  DD DISP=SHR,DSN=IDA.PSEGLIB
//*-----
```

Example of PSS/MVS startup procedure

5.1.4 PSS/VM PDM definition

```
USER IDAPSS PASSWORD 10M 16M ABDG 64 OFF OFF OFF
ACCOUNT 3000 UDV
OPTION ECMODE VCUNOSHR
SCR INA GRE NON STATA RED NON CPOUT YEL NON VMOUT BLU NON INRED WHI NON
IPL GCS PARM AUTOLOG
  CONSOLE 009 3215 T OPERATOR
  SPOOL 00C 2540 READER *
  SPOOL 00D 2540 PUNCH A
  SPOOL 00E 1403 A
* LINK TO GCS DISK
  LINK MAINT 595 595 RR
* LINK TO FONT300, PAGEDEF, FORMDEF, OVERLAY & PAGESEGS
  LINK MAINT 498 498 RR
* WORK DASD
MDISK 191 3380 191 20 VMPK25 MW
```

Example of PSS/VM PDM definitions

```
/* **** */
/*
/* IDA AFP EXEC Version 6 Release 01 - (C) Copyright I-data A/S 1994 */
/* Process parm and transfer them to IDA AFP virtual machine */
/*
/* Dependencies: LIST3820, LIST38PP */
/* PSEG3820, PSEG38PP, PSEG300 */
/* OVLY3820, OVLY38PP */
/* and normal files (line data files) */
/*
/* **** */

FSSUSER = 'PSS1' /* USERID OFF VIRTUAL MACHINE PRINTING */

/* filetypes used by the program for xxxx3820 types */

list3820 = 'LIST3820'
ovly3820 = 'OVLY38PP'
fdef3820 = 'FDEF38PP'
pdef3820 = 'PDEF38PP'
pseg3820 = 'PSEG38PP' /* point to normal pictures */
font3820 = 'FONT300B' /* point to normal fonts */

/* Default values */

ch0 = '' /* parm values */
ch1 = ''
ch2 = ''
ch3 = ''
copy = '0'
formdef = ''
pagedef = ''
overlay = ''
cc = 'NOCC'
trc = ''
duplex = ''
bin = ''
xoffset = '9999' /* 9999 will use profile offset */
yoffset = '9999'
orient = ''
prid = '' /* printer name */
class = ''
fcb = ''
prmode = ''
pimsg = '20'
picnt = '0'
datack = 'U'

/* Types that will get CC on if nothing is specified */

cctype.1 = 'LISTING'
cctype.2 = 'PLI'
cctype.3 = 'LIST3800'
cctype.4 = '3800'
cctype.5 = '1403'
```

Sample PSS EXEC (part)

5.1.5 PSS printer profile using SNA and TCP/IP attachment

```
KEY          KEY=01234567890123450123
DDNAME      DDNAME=PSS4.TEMP
VOLID       VOLID=MVSPK1
SMF         TYPE=234
*-----
* GLOBAL DEFAULT USED BY ALL PSS
*-----
FORM        FORM=LAND ,PAGEDEF=ALM8 ,FORMDEF=
CLASS       CLASS=F ,PAGEDEF=ASM ,FORMDEF=ASM ,XOFFSET=0 ,YOFFSET=0
*-----
DEFAULT     LOGMODE=RSCSPRT1 ,FDEFLIB=FDEF38PP ,
            PDEFLIB=PDEF38PP ,OVLYLIB=OVLY38PP ,
            FONTLIB=FONT300 ,COMPRESS ,
            RESOURCE= ,FONT=GT12 ,PAGEDEF=DEF ,
            PSEGLIB=PSEG38PP ,SCALE ,
            XSIZE=8 ,YSIZE=11 ,XOFFSET=0 ,YOFFSET=0
            HPDEF=HEAD ,TPDEF=HEAD ,
            HFDEF=HEAD ,TFDEF=HEAD
FSSNAME     PSS4                      - NAME IF PSS TO READ THIS
FSANAME     FSANAME=IDAFSA4
*-----
* LOCAL DEFINITIONS USED BY PSS4 (PROC NAME)
*-----
DEFAULT     LOGMODE=RSCSPRT1
APPLID      APPLID=IDAPSS4
*-----
* PSS PRINTER DEFINITION FOR USE WITH THE IDA REROUTER
*-----
PRINTER     PRTID=PRT410 ,LUNAME=IDNET023 ,
            LOGMODE=IBM3820T ,
            LOGDD=CONSOLE ,
            RETRY=10 ,
            BINM=2 ,
            XOFFSET=0 ,
            YOFFSET=0
            HPDEF=HEAD2 ,TPDEF=HEAD2 ,
            HFDEF=HEAD ,TFDEF=HEAD
*-----
```

5.1.6 Host VTAM definition

```
APPLPSF      VBUILD      TYPE=APPL
*
*
PSFAPP11    APPL          AUTH=ACQ , EAS=1 , SONSCIP=YES
PSFAPP12     APPL          AUTH=ACQ , EAS=1 , SONSCIP=YES
PSFAPP13     APPL          AUTH=ACQ , EAS=1 , SONSCIP=YES
```

Example of MVSSE VTAM application definition for PSF

```
NETID=DKIDTN01,          THIS NETWORK'S ID          X
SSCPNAME=DKIDTM02                X
HOSTPU=DKIDSTP02,                X
SSCPID=32,                        X
COLD,                             X
CONFIG=00,                        X
CSLALIMIT=0,                      X
HOSTSA=32,                        X
DLRTCB=32,                        X
LIST=99,                           X
NOPROMPT,                          X
SUPP=NOSUP,                        X
TNSTAT,CNSL,TIME=120,             X
NOTRACE,TYPE=VTAM,                X
CRPLBUF=(208,,15,,1,16),          X
IOBUF=(100,128,19, ,1,20)         X
LFBUF=(64,,0,,1,1),               X
SFBUF=(163,,0,,1,1),              X
WPBUF=(78,,0,,1,1)                X
```

Example of VTAM member taken from an MVS system

```
IBM3820T  MODEENT LOGMODE=IBM3820T,FMPROF=X'13',TSPROF=X'07'          X
PRIPROT=X'B0',SECPROT=X'B0',COMPROT=X'D0B1'                               X
RUSIZES=X'8787',                                                            X
SSNDPAC=X'00',SRCVPAC=X'10', PSNDPAC=X'10',                               X
PSERVIC=X'06020000000000000000000020000'
```

Example of VTAM LOGMODE

MODE TABLE:

	LOCAL 37XX SDLC	REMOTE 37XX SDLC/TR	LOCAL 3174 TR GATEWAY	REMOTE 3174 TR GATEWAY	LOCAL 3172 ETHERNE T GATEWAY	LOCAL 37XX TR ATTACHMENT
LOGMODE	IBM3820M	IBM3820R	IBM3820T	IBM3820R	IBM3820T	IBM3820T
FMPROF	X'13'	X'13'	X'13'	X'13'	X'13'	X'13'
TSPROF	X'07'	X'07'	X'07'	X'07'	X'07'	X'07'
PRIPROT	X'B0'	X'B0'	X'B0'	X'B0'	X'B0'	X'B0'
SECPROT	X'B0'	X'B0'	X'B0'	X'B0'	X'B0'	X'B0'
COMPROT	X'D0B1'	X'D0B1'	X'D0B1'	X'D0B1'	X'D0B1'	X'D0B1'
RUSIZES	X'B7B7'	X'8686'	X'8787'	X'8686'	X'8787'	X'8787'
PSNDPAC	X'03'	X'10'	X'10'	X'10'	X'10'	X'10'
SSNDPAC	X'00'	X'00'	X'00'	X'00'	X'00'	X'00'
SRCVPAC	X'03'	X'10'	X'10'	X'10'	X'10'	X'10'
PSERVIC	X'060200000000000000002000'					

NOTE:

RUSIZES field is less than the VTAM major node MAXDATA parameter.

If using 3174, RUSIZES **must** match token ring address configuration (F) value.

PSERVIC is same for all configurations.

Example of VTAM PARAMETERS

Chapter 7: Workstation Configuration provides **S/370** configuration worksheets for the remote devices - *ida 913-03 Token Ring* and *ida PrintServer 13*.

6. Configuration of AS/400 Networks

The object of this chapter is to provide you with guidelines for *manual* configuration of your AS/400 system connecting to an IPDS session. The examples assume that configuration is made for a Token Ring attached workstation.

6.1 Creating APPC device description

Type: CRTDEVAPPC

Prompts:	Parameter and values in parentheses
Device description:	DEVD(RER1APPC)
Remote location name:	RMTLOCNAME(RER1) This value must match the remote location name (RMTLOCNAME) parameter in the CRTDEVPRT (Create Device Description Printer) command description. This value must be unique within a network.
Remote network identifier	RMTNETID (DKIDTN01) Enter the name of the network in which your partner logical unit is located.
Attached controller:	CTL(IDATA1) This name matches the local Node name in the local Node characteristics panel of the Communications Manager SNA Network Definitions.
Mode	MODE(QSPWTR) QSPWTR is an IBM supplied mode.
APPN capable	APPN (*YES)
Single session	SNGSNN (*NO)
Text 'description'	TEXT('APPC device for RER1PRT')

6.2 Creating Printer Device Description

Type: CRTDEVPRT

Prompts:	Parameter and values in parentheses
Device description	DEVD(RER1PRT)
Device class	DEVCLS(*RMT)
Device model	MODEL(0)
Device type	Type (*IPDS)
Advanced function printing	AFP (*YES) The default for this parameter is *NO. However, for AFP printing this parameter must be *YES.
AFP attachment	AFPATTACH(*APPC)
Font identifier	FONT (011)
Form Feed	FORMFEED(*AUTOCUT)
Remote location name:	RMTLOCNAME(RER1) This name matches the AS/400 RMTLOCNAME parameter value in the CRTDEVAPPC command. In this example, the value is RER1.
	The value must be unique within the network.
Remote network identifier	RMTNETID (DKIDTN01) Enter the name of the network in which your partner LU is located.
Mode	MODE(QSPWTR) QSPWTR is an IBM supplied mode
TEXT 'description'	TEXT ('PRT DEVICE FOR RER1')

6.3 Updating APPN Remote Location List

(SNA connections only)

The APPN location lists, which are only used for APPN configurations (i.e. when APPN /*YES) is specified in the controller description, define special characteristics of remote locations.

The CRTFGL (Create Configuration List) command is used to define a list of remote locations for APPN.

1. If you do not have a remote location list, type: **CRTCFGL** or, if you have a remote location list, type: **CHGCFGL** (change configuration list)
2. Press F4 to get prompts.
3. Type **APPNRMT** for the "Configuration list type" field and press the ENTER key twice.

Remote Location Name (RER1)

Specifies the name that must match the following:

- * RMTLOCNAME in the printer device description

This value must be unique within a network.

Remote Network Identifier (DKIDTN01)

Specifies the name that must match the following:

- * RMTNETID in the controller description
- * RMTNETID in the printer device description
- * PC's network name in Communications Manager SNA Base Profile

Local Location Name (S4450327)

The local location name is the name defined in the network attributes. The value for Local Location Name can be obtained by using the DSPNETA value. This value must match the following:

- * LCLLOCNAME in the printer device description
- * PC's Partner LU name

Remote Control Point Name

Specifies the name that must match the following:

- * CTL in the APPC device controller
- * Local Node Name in Communications Manager

Control Point Network Identifier

Specify *NETATR
Specify loc: (*NO)
Single session: (*NO)
Number of conversations: 10
Local Control Point: (*NO)
Pre-established session: (*NO)

NOTE: Use the WRKCFGL (Work Configuration List) command to view these parameters and their assigned values.

6.4 Sample Controller Definition

Controller description.....	* IDATA1
Option.....	* BASIC
Category of controller.....	* APPC
Link type.....	* LAN
Online at IPL.....	* NO
Active switched line.....	TRNLINE
Character code.....	* EBCDIC
Maximum frame size.....	*LINKTYPE
Remote network identifier.....	DKIDTN01
Remote control point.....	IDATA1
Initial connection.....	* DIAL
Dial initiation.....	* LINKTYPE
Switched disconnect.....	*YES
Data link role.....	* NEG
LAN remote adapter address.....	40005A0000CE
Option.....	* BASIC
Category of controllers.....	* APPC
LAN DSAP.....	* 04
LAN SSAP.....	* 04
Text.....	* AUTOMATICALLY CREATED BY QLUS

Chapter 7: "Workstation Configuration" provides **AS/400** configuration worksheets for the remote devices - ida 913-03 Token Ring and ida PrintServer 13.

7. Workstation Configuration

- For SNA connection -

The PC configuration description of Communications Manager/2, LAPS and TCP/IP includes both the **AS/400** and the **S/370 (S/390)** network systems.

7.1 Communications Manager/2 for S/370-390 and AS/400

This section describes the configuration of Communications Manager/2 for the two network systems S/370 (S/390) and AS/400.

The configuration details is followed by configuration worksheets for the two network systems. See section 7.1.2: "S/370 Network Configuration Worksheet" and section 7.1.3: "AS/400 Network Configuration Worksheet".

An explanation to the worksheets can be seen in section 7.1.4: "Explanation to configuration Worksheets".

NOTE:

The *ida ReRouter* setup values and the Communications Manager/2 profiles **must** match the corresponding parameters of the Host network.

The configuration examples assume that the connections are based on Token Ring.

You start the configuration from the program "Communications Manager Setup" in the Communications Manager/2 folder.

In the following, the screen to be configured will appear in a frame. Underneath you will find the instructions to follow. The numbers in the brackets, (e.g (5)) refer to the corresponding number in the Configuration Worksheet for Communications Manager/2. See the sections 7.1.2 (S/370) and 7.1.3 (AS/400).

7.1.1 Changing configuration file

Communications Manager Setup

1. Select "**Setup**" to create or modify a configuration
2. Enter the name of the configuration file you wish to modify in "**Configuration**"
3. Select "**OK**".

Communications Manager Configuration Def.

1. Select "**Token Ring or other LAN types**"
2. Select "**APPC APIs**" in the field "Features or Applications"
3. Select "**Configure**"

Configuring Data Link Control (DLC) profiles

Communications Manager Profile List Sheet

1. Select "**DLC-Token Ring or other LAN types**"
2. Select "**Configure**"

Token Ring or Other LAN Types DLC Adapter Parameters

1. Select "**Adapter**", see worksheet (2)
2. Set "**Maximum link stations**" to: see worksheet (3)
3. Set "**Maximum i-field size**" to: see worksheet (4)
4. Set "**C&SCM LAN ID**" to: see worksheet (5)

The remaining fields can be set to default value.

5. Select "**OK**"

Configuring SNA local node characteristics

Communications Manager Profile List Sheet

1. Select "**SNA local node characteristics**"
2. Select "**Configure**"

Local Node Characteristics

1. Set "**Network ID**" to, see worksheet (6)
2. Set "**Local node name**" to the number of your workstation (from the host)
3. Set "**Node type**"
If set to "End node - to network node server", then also define "Your network node server address" (hex)
4. Set "**Local node ID**" (the value for Local node ID should be supplied to you by your local network support manager)
NOTE: Do not change the value X'05D' for the left-most field of the local node ID.
5. Select "**Options**"
6. Set "**Local node alias name**".
7. Select: "**Activate Attach Manager at Startup**".
8. Click on "**OK**"

Configuring SNA connection

Communications Manager Profile List Sheet

1. Select "**SNA connections**"
2. Select "**Configure**"

Connection List

The connection may already have been defined. If so, check that the connection matches the description below. (If the connection is to be changed, select "Change" instead of "Create.")

For S/370 host connection:

1. Select **"To host"** under partner type
2. Select **"Create"**

For AS/400 host connection:

1. Select **"To peer node"**
2. Select **"Create"**

Adapter List

1. Select the relevant adapter under **" Adapter type "**
2. Select **"Adapter number"**, see worksheet (2)
3. Select **"Continue"**

Connection to a Host /Network node /Peer Node

Three types of connections are available:

1. Network node connection (normally AS/400):

- 1a. Select **"Activate at Startup"**.
- 1b. Set **"LAN Destination address"**, see worksheet (16)
- 1c. Specify **"Address format"**. This parameter will depend on the physical method of connection.
- 1d. Select: **"Use this network node as your preferred server"**.

2. Host connection (normally S/370-390):

- 2a. Select "Activate at startup"
- 2b. Select "Local PU Name"
- 2c. Select "APPN Support" (if needed)
- 2d. Set "Node ID", see worksheet (8)
- 2e. Set "LAN destination address" to: see worksheet (16)
- 2 f. Specify "Address format" as required
- 2g. Fill in "Partner network ID" see worksheet (11)
- 2h. Fill in "Partner node name" see worksheet (11)

3. Peer node connection (normally AS/400):

- 3a. Select "Activate at startup"
 - 3b. Set "LAN destination address" to see worksheet (16)
 - 3c. Specify "Address format"
 - 3d. Set "Remote SAP"
 - 3e. Fill in the "Partner network ID", see worksheet (11)
 - 3f. Fill in the "Partner node name", see worksheet (11)
4. Select "OK"

Connections List

1. Select "Close"

Configuring SNA features

Communications Manager Profile List Sheet

1. Select "SNA Features"
2. Select "Configure"

Creating a local LU

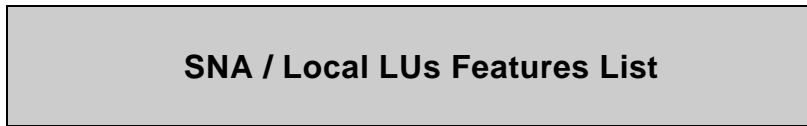

1. Select "**Local LUs**"
2. Select "**Create**"

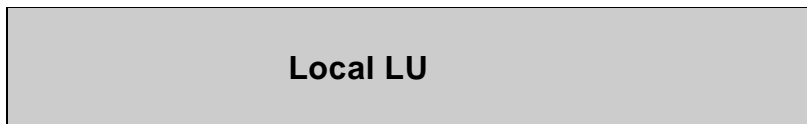

1. Set "**LU name**" to: see worksheet (14)
2. Set "**Alias**" to: see worksheet (15)
The LU Alias must be the same as defined in the *ida ReRouter*.
3. If *dependent* LUs are being used select LU NAU address (16).
4. Select "**OK**"



Optional
parameter -
CM dependent

1. Select "**Partner LUs**"
2. Select "**Create**"
3. Set "**Fully Qualified LU**" to: see worksheet (11)
4. Set "**Partner LU Alias**" (user defined)
5. Select "**OK**"

NOTE: With **Communications Manager/2**, version 1.11 or higher, special setup definitions have to be made to make a VTAM LU 6.2 session work.

1. The partner LU must be defined. Fill in the Network ID and Partner Node Name in accordance with the VTAM definitions (consult your VTAM programmer if needed).
2. In the Partner LU configuration screen, you must tick the field "Conversation Security verification" or else the VTAM session will not become operational.

**Mode Definition
(AS/400 only)**

1. Select "**Modes**", see worksheet (19)
2. Select "**Create**"
3. Enter the value "**QSPWTR**"
4. Select "OK"

Creating a transaction program definition

SNA Features List / Transaction Program Def.

1. Select "**Transaction program definitions**"
2. Select "**Create**"

Transaction Program Definition

For IPDS connection to PSF/370-390 and PSF/400:

1. Set "**Transaction program (TP) name**" to: **\$DPF**
(See worksheet (9))
2. Set "**OS/2 program path and file name**"
(*ida ReRouter* program) to: see worksheet (10)
3. Select "**Continue**"

For ICDS connection to ida PSS:

1. Set "**Transaction program (TP) name**" to:IDAROUTE
2. Set "**OS/2 program path and file name**" to:
see worksheet (10)
3. Set program parameter strings to "**IDAROUTE**".
4. Select "**Continue**".

Note: The TP name used must match the TP name used in the PSS printer profile (i.e. in this case it is IDAROUTE).

For details, see the section "Related Manuals" for documentation reference to host configuration

Additional TP Parameters

1. Select "**Background**" from the "Presentation type" list.
2. Select "**Non-queued Attach Manager started**" from the "Operation type" list.
3. Select "**OK**".

SNA Features List

1. Select "**Close**"

Communications Manager Profile List Sheet

1. Select "**Close**"

Communications Manager Configuration Def.

1. Select "**Close**"

Your configuration file is automatically verified.

You may now be presented with a pop-up window with the following message: "Do you wish to dynamically update your SNA resources". Select "**YES**".

Select "**Close**" to exit from Communications Manager Setup.

NOTE:

At this point it is recommended that the Communications Manager is stopped and restarted before proceeding with the operation of the *ida ReRouter* program.

7.1.2 S/370 Network Configuration Worksheet

On the following pages you will find sample configuration worksheets for two remote devices connected to the *ida ReRouter*, the *ida 913-03 Token Ring* and the *ida PS 13*, using the dependent LUs.

First device: ida 913-03 Token Ring

WORKSTATION:		Comm. Manager/2	LAPS	PSF	VTAM	NCP	IDA REROUTER	KEYWORDS
1	Configuration filename	TOKENR						
Token Ring DLC Profile								
2	Adapter number	0						
3	Max. link stations	10						
4	Max.RU size	1024			1024	1024		
5	C&SM LAN ID	IDATA1						
Local Node Characteristics								
6	Network name	DKIDTN01			DKIDTN01	DKIDTN01		
7	Local node name	IDATA1						
8	Node ID	05D 00000			05D 00000	05D 00000		
SNA Features: Transaction Program Def.								
9	TP name	\$DPF (for IPDS) IDAROUTE (for ICDS)						
10	Program path / name	C:\IDAROUTE\IDAROUTE.EXE						
Partner LU								
11	Full PLU name	DKIDTN01.PSFAPP11		PSFAPP11	PSFAPP11	PSFAPP11		
Local LU								
12	Local LU name	IDSNCEP0		IDSNCEP0	IDSNCEP0	IDSNCEP0	IDSNCEP0	
13	Local LU alias	SNCEP0						
14	Local LU address	4			4	4	4	
Connections								
15	Destination address	40005A0001C1					40005A0001C1	
16	LAN adapter address		40005A0000D5		40005A0000D5	40005A0000D5		
17	IP Address							
18	Port number							

Second device: ida PS 13

WORK-STATION:		Comm. Manager/2	LAPS	PSF	VTAM	NCP	IDA REROUTER	KEYWORDS
1	Configuration filename	TOKENR						
Token Ring DLC Profile								
2	Adapter number	0						
3	Max. link stations	10						
4	Max.RU size	1024			1024			
5	C&SM LAN ID	IDATA1						
Local Node Characteristics								
6	Network name	DKIDTN01			DKIDTN01			
7	Local node name	IDATA1						
8	Node ID	05D 00000			05D 00000			
SNA Features:								
Transaction Program Def.								
9	TP name	\$DPF (for IPDS) IDAROUTE (for ICDS)						
10	Program path / name	C:\IDAROUTE\IDAROUTE.EXE						
Partner LU								
11	Full PLU name ¹	DKIDTN01.PSFAPP12		PSFAPP12	DKIDTN01	PSFAPP12		
Local LU								
12	Local LU name	IDSNCEP1		IDSNCEP1	IDSNCEP1	IDSNCEP1	IDSNCEP1	
13	Local LU alias	SNCEP1						
14	Local LU address	5			5		5	
Connections								
15	Destination address	40005A0001C1					40005A0001C1	
16	LAN adapter address		40005A0000D5		40005A0000D5			
17	IP Address							
18	Port number							

¹ This profile description is also valid for "Partner Network ID" and "Partner Node Name".

7.1.3 AS/400 Network Configuration Worksheet

This section provides details on the configuration worksheets for two remote devices connected to the *ida ReRouter*: the *ida 913-03 Token Ring* and the *ida PS 13*.

First device: ida 913-03 Token Ring - Part 1.

WORKSTATION:		Comm. Manager/2	LAPS	TR LINE	APPCController
1	Configuration filename	TOKENR			
Token Ring DCL Profile					
2	Adapter number	0			0
3	Max. link stations	2			
4	Max.RU size	1024		1024	*CALC
5	C&SM LAN ID	IDATA1			
Local Node Characteristics					
6	Network name (ID)	DKIDTN01			DKIDTN01
7	Local node name	IDATA1			IDATA1
8	Local Node ID	05D 00000			05D 00000
Transaction Program Def.					
9	TP name	\$DPF			
10	Program path / name	C:\IDAROUTE\IDAROUTE.EXE			
Partner LU					
11	Full PLU name				
⇨	Partner network ID	DKIDTN01.			DKIDTN01.
⇨	Partner node name	S4450327			S4450327
Local LU					
12	Local LU name	RER1			
13	Local LU alias	MYALIAS			
14	Local LU address				
Connections					
15	Destination address	40000B100002		40000B100002	
16	LAN Adapter addr.		40005A0000D5		
17	IP Address				
18	Port No. .				
Mode Profile					
19	Mode name	QSPWTR			

First device: ida 913-03 Token Ring - Part 2.

WORKSTATION:		APPCDev	Printer Dev.	Configuration List	IDA REROUTER
1	Configuration filename				
Token Ring DCL Profile					
2	Adapter number				
3	Max. link stations				
4	Max.RU size	1024			
5	C&SM LAN ID				
Local Node Characteristics					
6	Network name (ID)	DKIDT01	DKIDT01	DKIDT01	
7	Local node name				
8	Local Node ID				
Transaction Program Def.					
9	TP name				
10	Program path / name				
Partner LU					
11	Full PLU name				
⇨	Partner network ID	DKIDTN01.	DKIDTN01.	DKIDTN01.	
⇨	Partner node name	S4450327	S4450327	S4450327	
Local LU					
12	Local LU name	RER1	RER1	RER1	
13	Local LU alias				MYALIAS
14	Local LU address				
Connections					
15	Destination address				
16	LAN Adapter addr.				
17	IP Address				192.0.5.9
18	Port No.				5001
Mode Profile					
19	Mode name	QSPWTR	QSPWTR		

Second device: ida PS 13 - Part 1.

WORK-STATION:		Comm.Manager/2	LAPS	TR LINE	APPController
1	Configuration filename	TOKENR			
Token Ring DCL Profile					
2	Adapter number	0			0
3	Max. link stations	2			
4	Max.RU size	1024		1024	1024
5	C&SM LAN ID	IDATA1			
Local Node Characteristics					
6	Network name (ID)	DKIDTn01			DKIDTn01
7	Local node name	IDATA1			IDATA1
8	Local Node ID	05D00000			05D00000
Transaction Program Def.					
9	TP name	\$DPF			
10	Program path / name	C:\IDAROUTE\IDARROUTE.EXE			
Partner LU					
11	Full PLU name	DKIDTN01 S4450327			DKIDTN01S4450327
Local LU					
12	Local LU name	RER2			
13	Local LU alias	RER2			
14	Local LU address				
Connections					
15	Destination address	40000B100002		40000B100002	
16	LAN Adapter addr.		40005A0000D5		
17	IP Address				
18	Port No. .				
Mode Profile					
19	Mode name	QSPWTR			

Second device: ida PS 13 - Part 2.

WORKSTATION		APPCDev	Printer Dev.	Config. List	IDA REROUTER
1	Configuration filename				
Token Ring DCL Profile					
2	Adapter number				
3	Max. link stations				
4	Max.RU size	1024			
5	C&SM LAN ID				
Local Node Characteristics					
6	Network name (ID)	DKIDTN01	DKIDTN01	DKIDTN01	
7	Local node name				
8	Local Node ID				
Transaction Program Def.					
9	TP name				
10	Program path / name				
Partner LU Profile					
11	Full PLU name	DKIDTN01.S4450327	DKIDTN01.S4450327	DKIDTN01.S4450327	
12	Partner network ID				
13	Partner node name				
Local APPC LU Profile					
12	Local LU name	RER2	RER2	RER2	
13	Local LU alias				MYALIAS
14	Local LU address				
Connections					
15	Destination address				
16	LAN Adapter addr.				
17	IP Address				192.0.5.10
18	Port No.				5001
Mode Profile					
19	Mode name	QSPWTR	QSPWTR		

7.1.4 Explanation to Configuration Worksheets

This chapter gives a description of each of the Communication Manager/2 profiles for S/370 - S/390 and AS/400 stated in the configuration worksheet (see the sections 7.1.2 for S/370 and section 7.1.3 for AS/400).

The numbers below refer to the profile numbers in the worksheet.

1. Configuration file name

This is the workstation's configuration filename to apply when installing and configuring Communications Manager/2.

2. Adapter number

This is a 1 byte digit indicating the adapter card number to be used.

3. Max. link stations

This value in Communications Manager specifies the maximum number of concurrent SNA links supported by the T/R adapter. Must not exceed the value called max. no. of SNA links specified in the LAN Adapter and Protocol Support (LAPS), IEEE 802.2 protocol.

4. Max. RU size

Specifies the maximum request/response unit (RU) size supported by the T/R adapter. This number must be the same or larger than:

- the NCP PU MAXDATA parameter specified in **S/370 - S/390**
and
- **AS/400** Token Ring Line description
- **AS/400** APPC Controller description

5. C&SM LAN ID

Specifies the identifier to be used by Communication & System Manager for Network Management functions.

6. Network name

This is the name of the network to which the workstation is connected. Must match:

- | | |
|-----------------------|-----------------------|
| S/370 - S/390: | VTAM NETID parameter. |
| AS/400: | RMTNETID parameter |

7. Local node name

The local node name is used in error logs and in Network Management alert messages to identify this workstation within the host system network. Co-ordinate this assignment with your network administrator.

8. Node ID

This identifier is used by the host to link with this workstation when attached to a T/R network. It must be unique within a switched node network. Co-ordinate this assignment with your network administrator.

S/370 - S/390:

Must match the host VTAM IDNUM configuration parameter. Set the Node ID parameter to zero (0) for an establishment controller (e.g. 3174). Co-ordinate this assignment with the network administrator.

AS/400:

This value will be used by AS/400 when automatically creating the APPC controller description for the PC.

9. TP name

The transaction program name (must be in capital letters).

10. Transaction program path / file name

Specifies the full path name, file name and file extension of the *C:\<path>\<filename>* program.

11. Full PLU name

Specifies the real network name of the Partner LU. The name has two parts:

1. Network ID
2. Partner LU (PLU) as specified within the network

S/370 - S/390:

Network ID is the VTAM NETID.

Partner LU Name is the application's (e.g. PSF) APPL ID in VTAM.

Remember also to tick the field "Conversation Security verification".

AS/400:

The *Network ID* can be obtained from the AS/400 RMTNETID parameter in

- AS/400 APPC controller description

The *Partner LU* is obtained from the AS/400 LCLLOCNAME parameter in:

- AS/400 APPC device description
- AS/400 APPC printer device description

12. Local LU name

Specifies the real name of the logical unit (LU) as known in the system. Must match the name in:

S/370 - S/390:

NCP/VTAM LU name.

AS/400:

AS/400 APPC device description
AS/400 printer device description

13. Local LU alias

Identifies the LU alias to be used when activated by the S/370 - S/390 or AS/400 system. This parameter must match the LU Alias in the *ida ReRouter* program.

14. Local LU address

Specifies the network addressable unit (NAU) for this logical unit (LU). It must match the NCP/VTAM LOCADDR. A value of X'00' specifies an independent LU and values between 2 and 255 (X'01' and X'FF') specify dependent LUs.

The support of independent LUs requires the following level of network hardware and software:

- ACF/VTAM level 3.3 ACF/NCP 4.2 or later
- Token Ring 37XX - ACF/VTAM 3.3, ACF/NCP 4.2 or later
- Establishment Controller (3174) Token Ring gateway
ACF/VTAM 3.3 microcode C1.0 or later

15. **LAN Destination address**

Specifies the destination address for a LAN adapter. The destination address is the address of the partner's LAN adapter.

16. **LAN adapter address**

This parameter is for S/370 - S/390 only!

Used by the VTAM (or an establishment controller, e.g. 3174) to communicate with the workstation.

17. **IP Address**

The IP address is the defined address of the remote device being communicated with.

Must be stated in decimal dotted notation:
0.0.0.1 - 255.255.255.254.

18. **Port No.**

Specifies (in decimal value) the actual port of the remote device being connected with. Port no. is 5001 and 5002 for all IPDS applications.

19. **Mode Name**

This parameter is for AS/400 only

This item must match the AS/400 mode parameter in

- AS/400 APPC device description
- AS/400 APPC printer device description

7.2 LAPS

When installing TCP/IP, a LAPS (LAN Adapter Protocol Support) protocol must be added for the TPC/IP in question.

First select network adapter and then add the protocol for the TCP/IP as illustrated in the screen below. The selected protocol will then appear in the field "Current Configuration".

Press "OK" to confirm the configuration.

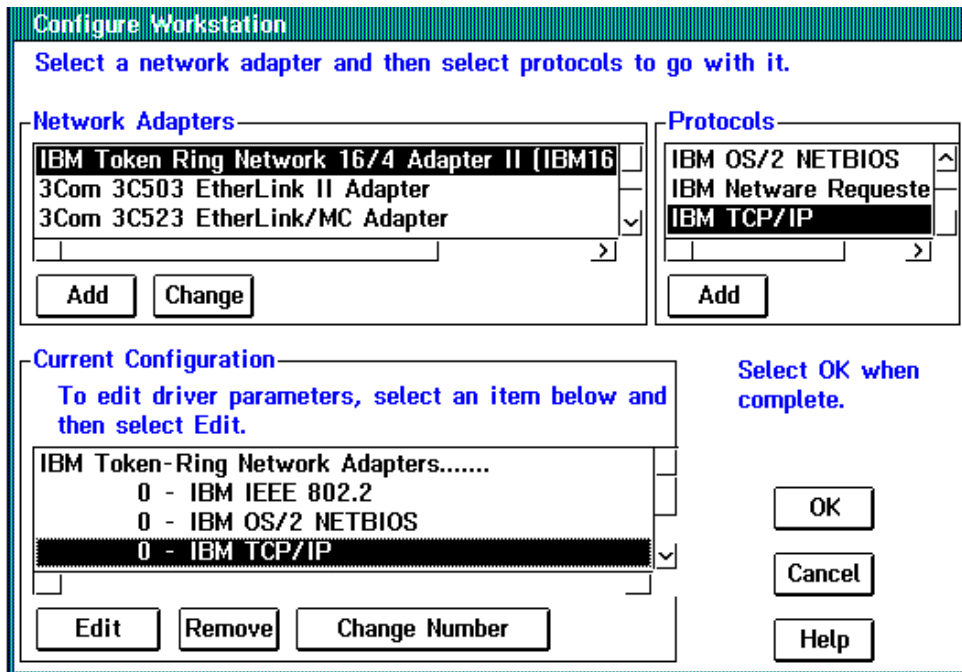

7.3 TCP/IP

The TCP/IP (Transmission Control Protocol / Internet Protocol) is used to transfer print data. The print data is encapsulated within the TCP/IP during network transmission and is passed transparently to the remote device.

When configuring the TCP/IP there are two parameters to define:

- network
- routing this, however, is only in case of multiple IP network connection

Network

Tick the field "Enable LAN Adapter 0" and define the IP address for the PC and subnet mask.

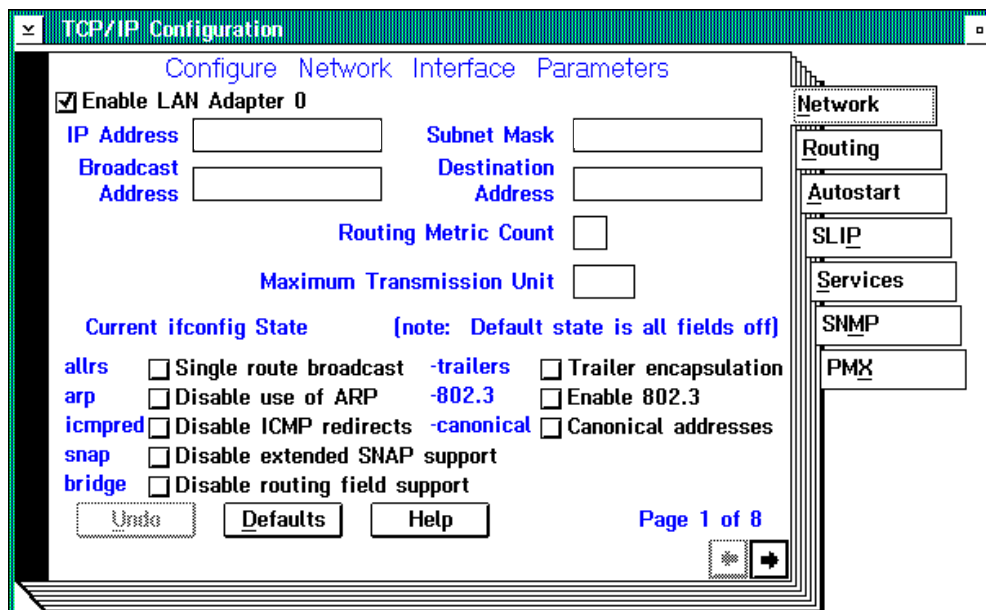

Routing

NOTE:

Routing is only defined if connection is made to multiple IP network.

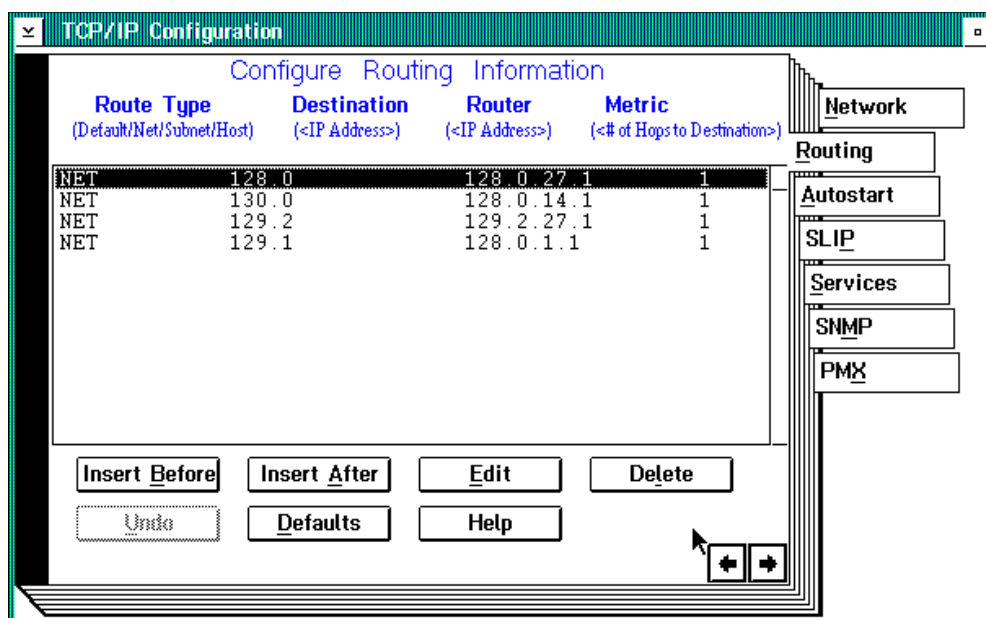

When configuration of the TCP/IP protocol is completed, you must confirm the configuration. Press ALT+ F4 or make a double click in the top left corner of the actual screen.

Then select "SAVE" to save the TCP/IP configuration.

8. Testing Connection to Remote Device

When the *ida ReRouter* has been installed and is ready for operation you are recommended to test the connection to the remote device being communicated with. For a list of remote printer devices being supported with the *ida ReRouter*, see chapter 1: "Introduction".

The remote devices to be operated with the *ida ReRouter* support the Internet Control Message Protocol (ICMP) PING function

8.1 PING Function

The PING function is used for testing the connection to the remote device. The PING function sends an echo request to the network host. The function is useful for:

- Determining the status of the network and various host connections.
- Tracking and isolating hardware and software problems.
- Testing, measuring and managing networks.

Before testing, make sure that the remote device is plugged in and attached correctly to the LAN.

1. Activate the TCP/IP protocol
2. "PING" the unit from the workstation. This verifies both physical LAN and IP network connectivity.
3. On the command line, enter the PING command and the IP address or host name of the unit.

E.g.

PING 192.0.5.7

PING function succeeded:

If the PING is OK, you receive a system response like this:

```
PING 192.0.5.7: 56 data bytes
64 bytes from 192.0.5.7: icmp_seq=0.
time=0. ms
64 bytes from 192.0.5.7: icmp_seq=1.
time=0. ms
64 bytes from 192.0.5.7: icmp_seq=2.
time=0. ms
64 bytes from 192.0.5.7: icmp_seq=3.
time=0. ms
64 bytes from 192.0.5.7: icmp_seq=4.
time=0. ms
```

```
----- 192.0.5.7 PING Statistics -----
```

4. Press CTRL-BREAK to end the PING process and receive the following message:

```
5 packets transmitted, 5 packets received, 0% packet loss
round-trip (ms)  min/avg/max 0 / 0 / 0.
```

PING function failed:

If the PING function failed to provide the expected system response, you should check the remote device as follows:

1. Make sure that power light on the remote device is ON and that the LAN light is ON (solid, not blinking). This means that the unit is connected to the LAN.
2. Press the TEST key on the remote printer device. A test page is generated on the printer.

NOTE: When you press the TEST key, you make a disconnection between the printer and the *ida ReRouter*. To restart, you simply send another job to this device.

If you need further instructions on how to PING the remote device, you are referred to the relevant TCP/IP documentation for the host you are using.

8.2 Log Files

In the following chapter 9: "Problem Determination", all the log files for the idaRoute program are described together with a suggested action to correct the error situation. All log messages sent to the log file will be time stamped.

A brief overview of the log files can be seen by activating the pull-down window "View Log" (see section 4.2, step 3 for details).

NOTE:

The status field will always be changed when new sessions are activated.

9. Problem Determination

The idaRoute program logs all errors. All entries in the log file are time stamped. Apart from the error messages indicated in the following, a number of status messages are also logged.

The errors produced will use the following syntax:

9.1 Error Syntax

Code: ROUTYYYYX

			→ Message identifier
/	/		E: Error
			I: Information
/	/		W: Warning
		—	→ Message number
—————			→ Program name

Description	A short diagnosis of the error situation
Action	The action you will have to take to remedy the error situation.
Note	Further information (if any) on the actual error situation

The following notation will apply in the error message code as a variable sequence or character:

[...]

ROUT0035E: Cannot open configuration file [...]

Description: The system is not properly configured. The configuration file "idaRoute.ini" is not created in the idaRoute directory.

Action: Use the idaRCtrl program to make the proper setup.

Note: -

ROUT0052E: Configuration error for entry [...]

Description: A configuration error has been found - [...] identifies the wrong keyword.

Action: Correct the entry, using the idaRCtrl.

Note: -

ROUT0104E: No reply generated from remote device [...]

Description: The printer application (e.g. HOST-PSF or idaPSS) has requested an ACK. However, the remote device has not answered before a timeout has occurred.

Action: Check the connection to the remote device, reset the device and try once more.

Note: -

ROUT0105E: APPC communication error

Description: A communication error has occurred. An invalid or unsupported status return code is sent from APPC API.

Action: The transaction program is terminated. To re-start the communication, operate/re-start the printer. If the problem persists, contact your system administrator..

Note: -

ROUT0106E: APPC allocation error [...]

Description: The transaction program has discovered an allocation error.

Action: The TP (transaction program) is not configured in the setup for the Communications Manager/2. Enter CM/2 and correct the TP.

or

- no allocation is pending in the program. The program has been started manually.

Note: -

ROUT0110E: Invalid APPC opcode [...]

Description: The transaction program has discovered an APPC syntax error.
Action: Try once more. If problem persists, contact your system administrator.
Note: -

ROUT0111E: APPC error: opcode [...] **Primary rc:**
Secondary rc:

Description: A situation with a communication failure has occurred.
Action: Check the configuration to the Host and the Communications Manager/2.
Try once more, if problem persists then contact your system administrator.
Note: -

ROUT0600E: Invalid IP Address value [...]

Description: The IP address in the idaRoute.ini file is invalid.
Action: Re-define the configuration value.
Note: -

ROUT0601E: Invalid Port No Value [...]

Description: The Port number defined in the idaRoute.ini file is invalid.
Action: Re-define the configuration value.
Note: -

ROUT0602E: Invalid connect timeout value [...]

Description: The value defined for the time out period is invalid.
Action: Re-define the configuration value.
Note: -

ROUT0603E: TCP/IP socket error [...]

Description: A situation with a communication failure has occurred.
Action: Check the remote device to see if it is ready and active.
"Ping" the remote device (for details.see chapter 8:"Testing the Remote Device").
Retry.
Note: -

ROUT0604E: TCP/IP communication error [...]

Description: A situation with a communication failure has occurred.
Action: Check the remote device to see if it is ready and active.
"Ping" the remote device
(for details.see chapter 8:"Testing the Remote Device").
Retry.
Note: -

ROUT0605E: No connection established to remote device

Description: An attempt to make a connection to the remote device has failed.
Action: Check the remote device to see if it is ready and active.
"Ping" the remote device
(for details.see chapter 8:"Testing the Remote Device").
Retry.
Note: -

ROUT0606W: Remote device already connected to another server

Description: The remote device is "owned" by another server.
Action: Deactivate the other server or use a different server.
Note:

ROUT0608I: idaRoute vers. [...] started

Description: Self-explanatory information.
Action: -
Note: -

ROUT0609I: idaRoute ended

Description: Self-explanatory information.
Action: -
Note: -

ROUT0610I: idaRCtrl deactivation request

Description: The transaction program is requested to deactivate. The request comes from the OS/2 user (idaRCtrl GUI).
Action: -
Note: **The printer / queue will be stopped on the Host system and active jobs will be interrupted.**

ROUT0611I: Trace enabled [...]

Description: Program trace is enabled.

Action:

Note: Trace information is written to the <LUALIAS>.trc file. (see section 9.2: "Trace" for further information).

ROUT0612W: SWIDDEF file error [...]

Description: The swiddef is either invalid or non-existing.

Action: Re-install or update the *ida ReRouter*.
If problem persists then contact your point of purchase.

Note: -

ROUT0613I: Printer is not ready (IRQ on remote printer)

Description: An IRQ message has been discovered in the remote printer.

Action: Check the remote printer to establish the IRQ situation (paper jam, paper out, off-line?).

Note: -

ROUT0614I: Printer is ready (IRQ solved)

Description: Information only.

Action: -

Note: -

ROUT0615E: TCP/IP printer protocol error

Description: A protocol error has occurred between the *ida ReRouter* and the remote device.

Action: Check the remote device and retry.

Note: -

ROUT0616I: Connection established to [...] port [...]

Description: A connection has been established to the IP address [...], port no. [...].

Action: -

Note: Information only.

ROUT0618I: Remote device (printer) is not ready

Description: An attempt to make a connection has failed.
Action: Check the remote device and retry.
Note: Make sure that a test page can be ejected from the remote device.

ROUT0619E: Cannot reach the specified destination

Description: Connection to the remote device cannot be established.
Action: Check the IP address
Check that the remote device is turned on
Ping the remote device
Note: -

ROUT0700E: Internal software error [...]

Description: An internal software error has occurred.
Action: Retry and if the problem persists contact your point of purchase.
Note: -

ROUT0800E: Semaphore handling error [...]

Description: An OS/2 system call has failed.
Action: Re-start the *ida ReRouter*, re-start the OS/2.
If problem persist, contact your system administrator.
Note: -

ROUT0801E: Named Pipe handling error [...]

Description: An OS/2 system call has failed.
Action: Re-start the *ida ReRouter*, re-start the OS/2.
If problem persist, contact your system administrator.
Note: -

ROUT0802E: Timer handling error [...]

Description: An OS/2 system call has failed.
Action: Re-start the *ida ReRouter*, re-start the OS/2.
If problem persist, contact your system administrator.
Note: -

ROUT0803E: Thread handling error [...]

Description: An OS/2 system call has failed.
Action: Re-start the *ida ReRouter*, re-start the OS/2.
If problem persists, contact your system administrator.
Note: -

9.2 Trace

The Trace entry in the setup screen (see chapter 4: "Installation and Setup of *ida ReRouter*") provides a debugging facility.

This facility can be enabled either by setting "TRACE" to a value within the defined range (see below) in the setup screen or set via the configuration file (*idaRoute.ini*). When TRACE has been enabled, an <LUALIAS>.trc will be generated to the directory of the *idaRoute* program.

Range: '0' (Off)
'???? 0010 1' (Dataflow, trace file wrapped [128kB])
'???? 0010 0' (Dataflow, trace file not wrapped)

Default: '0' (OFF)

NOTE: The trace file is basically for internal i-data use only.

10. List of Abbreviations

APPC	Advanced Program to Program Communication
IP	Internet Protocol
LU	Logical Unit
PING	Packet InterNet Group
PM	Presentation Manager
PPD/PPR	PPD (Page Printer Daemon) and PPR (Page Printer Remote) are bi-directional print protocols for AFP printing in a TCP/IP environment
TCP/IP	Transmission Control Protocol/Internet Protocol
LAPS	LAN Adapter Protocol Support

Appendix A: Keyword Definitions

The configuration file - *idaRoute.ini* - created upon completion of the setup dialog (see section 4.2: Setup of *ida ReRouter*) consists of multiple route definitions. Each route definition is a set of keywords defining the actual setting of the route. The configuration file is not used for normal configuration and operation. For this you use the setup dialog screen.

The valid keywords are described in details below and the syntax for the keyword settings is as follows:

Syntax:

```
KEYWORD <SPACE> VALUE <CRLF>
```

NOTE: Keywords are case sensitive and must be stated in upper case.

Comments must be placed on a line above and below the settings line.

KEYWORD:	"DEFINE_ROUTE"
DESCRIPTION:	Starts the definition of an LU 6.2 to TCP/IP route
RANGE:	-
DEFAULT:	-
KEYWORD:	"END"
DESCRIPTION:	Ends the route definition
RANGE:	-
DEFAULT:	-

KEYWORD: "ROUTE_NAME"

DESCRIPTION: User defined Alias for a particular route.

RANGE: Alphanumerical string (A-Z, a-z and 0-9)
No white spaces
Max. 15 characters

DEFAULT: None

KEYWORD: "DESCRIPTION"

DESCRIPTION: A short description of the defined route

RANGE: Alphanumerical string (A-Z, a-z and 0-9). All characters before the value <CRLF> are used as the string (spaces included)-
Max. 30 characters

DEFAULT: None

KEYWORD: "LUALIAS"

DESCRIPTION: Name of the logical unit used for LU 6.2 connection. The LU Alias should match the LU Alias defined in the Communications Manager (ES or /2) setup.
The LU Alias is case sensitive and must be stated in upper case.

RANGE: Alphanumerical string (A-Z, a-z and 0-9). No white spaces.
Max. 8 characters

DEFAULT: None

KEYWORD:	"IPADDRESS"	<i>Together IPADDRESS and PORTNO specify the actual remote application to reach</i>
DESCRIPTION:	The Internet Protocol address for the TCP/IP device.	
RANGE:	Decimal dotted notation 0.0.0.0. - 255.255.255.255	
DEFAULT:	None	
KEYWORD:	"PORTNO"	
DESCRIPTION:	Specifies the actual port number of the remote printer device (printer daemon)	
RANGE:	Decimal value 0-9999	
DEFAULT:	5001	
KEYWORD:	"CONTIMEOUT"	
DESCRIPTION:	Specifies the time the idaRoute (the .ini file) will wait from the time of connection till response is received.	
RANGE:	Decimal values in seconds 0-9999.	
DEFAULT:	30	
KEYWORD:	"TRACE"	
DESCRIPTION:	Enables/disables the trace functionality in the idaRoute program	
RANGE:	'0' (Off) '???? 0010 1' (Dataflow, trace file wrapped [128kB]) '???? 0010 0' (Dataflow, trace file not wrapped)	
DEFAULT:	'0' (Off)	

Appendix B: Fill-In Configuration Worksheet

In the following pages, you will find blank configuration worksheets for the networks S/370 and AS/400.

With these you can make your own system configuration worksheets.

Fill-In Configuration Worksheet for S/370 Networks

Remote Device: _____

WORK-STATION:		Comm. Manager/2	LAPS	PSF	VTAM	NCP	IDA REROUTER
1	Configuration filename						
Token Ring DLC Profile							
2	Adapter number						
3	Max. link stations						
4	Max.RU size						
5	C&SM LAN ID						
Local Node Characteristics							
6	Network name				NETID		
7	Local node name						
8	Node ID						
SNA Features:							
Transaction Program Def.							
9	TP name						
10	Program path / name						
Partner LU							
11	Full PLU name ²						
Local LU							
12	Local LU name			LUNAME	LUNAME	LUNAME	
13	Local LU alias						
14	Local LU address						
Connections							
15	Destination address						
16	LAN adapter address						
17	IP Address						
18	Port number						

² This profile description is also valid for "Partner Network ID" and "Partner Node Name".

Fill-In Configuration Worksheet for AS/400 - Part 1.

Remote Device: _____

WORK-STATION:		TR LINE	APPCCont
Comm. Manager/2 LAPS			
1	Configuration filename		
Token Ring DCL Profile			
2	Adapter number		ADPTADR
3	Max. link stations		
4	Max.RU size	MAXFRAME	MAXFRAME
5	C&SM LAN ID		
Local Node Characteristics			
6	Network name (ID)		RMTNETID
7	Local node name		RMTCPNAME
8	Local Node ID		EXCHID
Transaction Program Def.			
9	TP name		
10	Program path / name		
Partner LU			
11	Full PLU name ³		RMTNETID
Local LU			
12	Local LU name		
13	Local LU alias		
14	Local LU address		LOCADDR
Connections			
15	Destination address	ADPTADR	
16	LAN Adapter addr.		
17	IP Address		
18	Port No. .		
Mode Profile			
19	Mode name		

³ This profile description is also valid for "Partner Network ID" and "Partner Node Name".

Fill-In Configuration Worksheet for AS/400 - Part 2.

COMMUNICATIONS MANAGER /2 PROFILE		APPCDev	Printer Dev.	Config. List	IDA REROUTE	REMOTE DEVICE
1	Configuration filename					
Token Ring DCL Profile						
2	Adapter number					
3	Max. link stations					
4	Max.RU size					
5	C&SM LAN ID					
Local Node Characteristics						
6	Network name (ID)	RMTNETID	RMTNETID	RMTNETID		
7	Local node name					
8	Local Node ID					
Transaction Program Def.						
9	TP name					
10	Program path / name					
Partner LU						
11	Full PLU name	RMTNETID	RMTNETID	LCLLOCNAME		
Local LU						
12	Local LU name	RMTLOCNAME	RMTLOCNAME			
13	Local LU alias					
14	Local LU address					
Connections						
15	Destination address					
16	LAN Adapter addr.					
17	IP Address					
18	Port No.					
Mode Profile						
19	Mode name	MODE	MODE			

Appendix C: i-data Products

Mainframe environment

	AFP	IPDS Laser	IPDS Matrix	Non-IPDS Laser	Non-IPDS Matrix
Hardware	<u>ida 270x</u> - Optra - 4039 - MIO - SIO <u>ida PDS</u> - 270 C/RS - LCD <u>ida 270 C/RS</u> <u>ida RPP</u> <u>ida LS 100</u> <u>ida 820 Font Pack</u> - MVS - VM	<u>ida PDS</u> - Optra - 4039 - MIO <u>ida PDS</u> - 270 C/RS - TR LCD - LCD	ida 234-11 MT 691 ida 234-11 MT 800	<u>ida 270x</u> - Optra - 4039 - MIO - SIO - G - Canon III - Canon 4 - Canon Plus <u>ida Flex</u> <u>ida LS 270</u> <u>ida 270 C/RS</u>	ida 224-1C - IBM 4072 - IBM 4226 - IBM 238x/9x - OKI 395 - OKI 520 -Epson SQ 2550 -ida 234-1 MT691 - ida 234-1MT800 <u>ida LS 170</u> <u>ida UNI</u> - 224-1C - 224-1CB <u>ida 270 C/RS</u>
Software	<u>ida PSS</u> - MVS - VM - VDE <u>ida RPPC</u> - OS/2 - Windows - WIN NT x86 - HP-UX - UNIX - Netware <u>ida ReRouter</u> <u>ida 820 Font Pack</u> - MVS - VM	- IBM PSF/2 -ida MakeITDS - MVS/VM/VSE - WIN - DOS <u>ida ReRouter</u>	IBM PSF/2 <u>ida ReRouter</u>		
Connectivity Platform	<u>ida PS</u> - x3 Conv. - x4 Conv. - x3 MIO - x4 MIO - x3 IOP - x4 IOP <u>ida TR</u> ida FLEX TR	<u>ida PS</u> - 13 Conv. - 14 Conv. - 13 MIO - 14 MIO - 13 IOP - 14 IOP <u>ida 913 LAN Brick</u>	<u>ida 913 LAN Brick</u>	<u>ida PS</u> - x3 Conv. - x4 Conv. - x3 MIO - x4 MIO - x3 IOP - x4 IOP <u>ida TR</u> ida FLEX TR	<u>ida PS</u> - x3 Conv. - x4 Conv. - x3 MIO - x4 MIO - x3 IOP - x4 IOP ida TR ida FLEX TR

Midrange environment

	AFP	IPDS Laser	IPDS Matrix	Non-IPDS Laser	Non-IPDS Matrix
Hardware	<u>ida 812-1x</u> - Optra - 4029 - 4039 - MIO - SIO - 250 C/RS	<u>ida PDS</u> - Optra - 4039 - MIO <u>ida PDS</u> - 250 C/RS - TR LCD - LCD	ida 234-12 MT 691 ida 234-12 MT 800	<u>ida 812-1x</u> - Optra - 4029 - 4039 - MIO - SIO - G - Canon III - Canon 4 - Canon Plus <u>ida Flex</u> <u>ida 250 C/RS</u> <u>ida LS 250</u>	ida 224-1T - IBM 4072 - IBM 4226 - IBM 238x/9x - OKI 395 - OKI 520 -Epson SQ 2550 -ida 234-1 MT 691 - ida 234-1 MT800 <u>ida LS 150</u> <u>ida UNI</u> - 224-2T - 224-2TB <u>ida 3x-400</u>
Software		- IBM PSF/2 - ida MakeITDS - AS/400 - WIN - DOS	IBM PSF/2	ida Forms Designer 400 +	
	<u>ida ReRouter</u>	<u>ida ReRouter</u>	<u>ida ReRouter</u>		
Connectivity Platform	<u>ida PS</u> - x3 Conv. - x4 Conv. - x3 MIO - x4 MIO - x3 IOP - x4 IOP <u>ida TR</u> <u>ida FLEX TR</u>	<u>ida PS</u> - 13 Conv. - 14 Conv. - 13 MIO - 14 MIO - 13 IOP - 14 IOP <u>ida 913 LAN</u> <u>Brick</u>	<u>ida 913 LAN</u> <u>Brick</u>	<u>ida PS</u> - x3 Conv. - x4 Conv. - x3 MIO - x4 MIO - x3 IOP - x4 IOP <u>ida TR</u> <u>ida FLEX TR</u>	<u>ida PS</u> - x3 Conv. - x4 Conv. - x3 MIO - x4 MIO - x3 IOP - x4 IOP <u>ida TR</u> <u>ida FLEX TR</u>

Reader's Comments

This manual is part of a library that serves as a reference source for programmers and operators of i-data equipment. This form may be used to communicate your view about this publication. Your interest is appreciated.

Comments may be written in your own language, use of English is not required.

Please send this form to:

Documentation

i-data international a-s
Vadstrupvej 35-43
DK-2880 Bagsvaerd
Denmark

or use our E-mail address at the Internet:

i-data @ i-data.com

Free Manuals Download Website

<http://myh66.com>

<http://usermanuals.us>

<http://www.somanuals.com>

<http://www.4manuals.cc>

<http://www.manual-lib.com>

<http://www.404manual.com>

<http://www.luxmanual.com>

<http://aubethermostatmanual.com>

Golf course search by state

<http://golfingnear.com>

Email search by domain

<http://emailbydomain.com>

Auto manuals search

<http://auto.somanuals.com>

TV manuals search

<http://tv.somanuals.com>