

Portable MP3-CD Player

User manual

EXP3320, EXP3321,
EXP3322, EXP3360,
EXP3361, EXP3362,
EXP3364, EXP3365

PHILIPS CONSUMER ELECTRONICS NORTH AMERICA

Knoxville, Tennessee 37914-1810, U.S.A.

Meet Philips at the Internet
<http://www.philips.com>



Need help? Call us!

Philips representatives are ready to help you
with any questions about your new product.

**CALL US BEFORE YOU CONSIDER
RETURNING THE PRODUCT!**

1-800-531-0039

or visit us on the web at www.philips.com



EXP3360, EXP3361, EXP3362,
EXP3363, EXP3364, EXP3365



PHILIPS

Download from www.Somanuals.com. All Manuals Search And Download.

LC/bk WK407 Issue 1

Printed in China

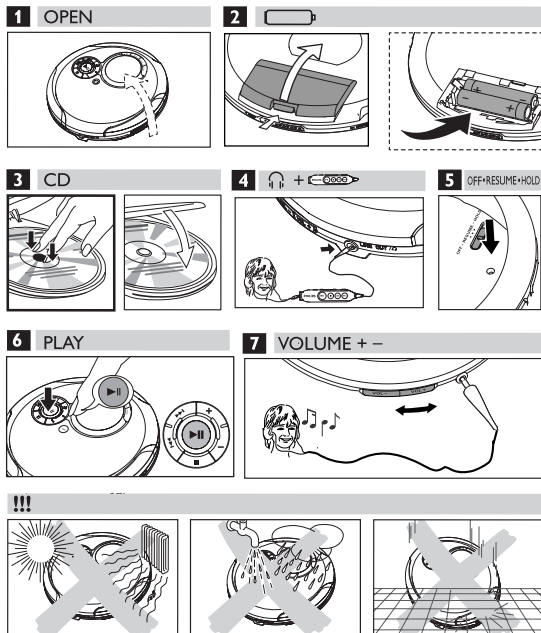
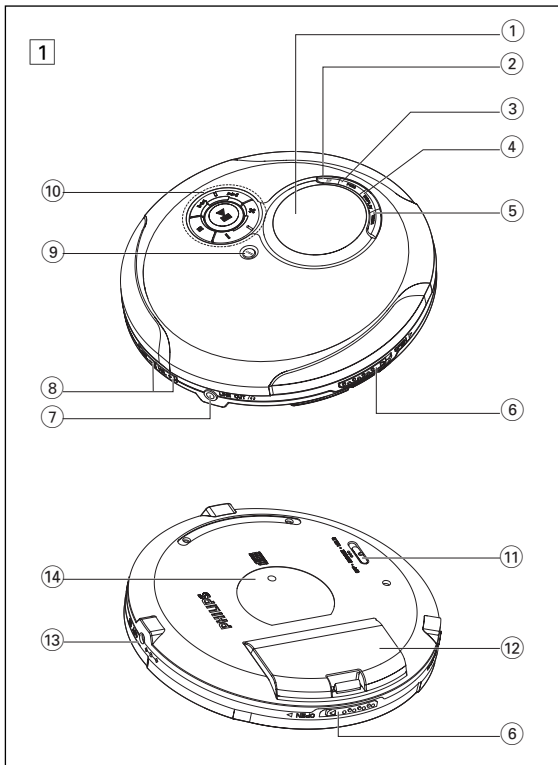

IMPORTANT SAFETY INSTRUCTIONS

1. **Read these instructions.**
2. **Keep these instructions.**
3. **Heed all warnings.**
4. **Follow all instructions.**
5. **Do not use this apparatus near water.**
6. **Clean only with a dry cloth.**
7. **Do not block any of the ventilation openings. Install in accordance with the manufacturers instructions.**
8. **Do not install near any heat sources** such as radiators, heat registers, stoves, or other apparatus (including amplifiers) that produce heat.
9. **Only use attachments/accessories** specified by the manufacturer.
10.  **Use only with a cart**, stand, tripod, bracket, or table specified by the manufacturer or sold with the apparatus. When a cart is used, use caution when moving the cart/apparatus combination to avoid injury from tip-over.
11. **Refer all servicing** to qualified service personnel. Servicing is required when the apparatus has been damaged in any way, such as if the power-supply cord or plug is damaged, liquid has been spilled or objects have fallen into the apparatus, or when the apparatus has been exposed to rain or moisture, does not operate normally, or has been dropped.
12. **Battery usage CAUTION** – To prevent battery leakage which may result in bodily injury, property damage, or damage to the unit:
 - Install **ALL** batteries correctly, + and - as marked on the unit.
 - Do not mix batteries (**OLD** and **NEW** or **CARBON** and **ALKALINE**, etc.).
 - Remove batteries when the unit is not used for a long time.
13. **Apparatus shall not be exposed to dripping or splashing.**
14. **Do not place any sources of danger on the apparatus.** (e.g. liquid filled objects, lighted candles).
15. This product may contain lead and mercury. Disposal of these material may be regulated due to environment considerations. **For disposal or recycling information, please contact your local authorities or the Electronic Industries Alliance : www.eiaa.org.**

EL 6475-E005: 04/01

Return your Product Registration Card today to get the very most from your purchase.

Registering your model with PHILIPS makes you eligible for all of the valuable benefits listed below, so don't miss out. Complete and return your Product Registration Card at once to ensure:

*Proof of Purchase

Returning the enclosed card guarantees that your date of purchase will be on file, so no additional paperwork will be required from you to obtain warranty service.

*Product Safety Notification

By registering your product, you'll receive notification - directly from the manufacturer - in the rare case of a product recall or safety defect.

*Additional Benefits of Product Ownership

Registering your product guarantees that you'll receive all of the privileges to which you're entitled, including special money-saving offers.

Know these **safety** symbols



 This "bolt of lightning" indicates uninsulated material within your unit may cause an electrical shock. For the safety of everyone in your household, please do not remove product covering.

 The "exclamation point" calls attention to features for which you should read the enclosed literature closely to prevent operating and maintenance problems.

For Customer Use

Enter below the Serial No. which is located on the rear of the cabinet. Retain this information for future reference.

Model No. _____

Serial No. _____

WARNING: To reduce the risk of fire or electric shock, this apparatus should not be exposed to rain or moisture, and objects filled with liquids, such as vases, should not be placed on this apparatus.

CAUTION: To prevent electric shock, match wide blade of plug to wide slot, fully insert.

ATTENTION: Pour éviter les choc électriques, introduire la lame la plus large de la fiche dans la borne correspondante de la prise et pousser jusqu'au fond.

Canada

English

This digital apparatus does not exceed the Class B limits for radio noise emissions from digital apparatus as set out in the Radio Interference Regulations of the Canadian Department of Communications.

Français

Cet appareil numérique n'émet pas de bruits radioélectriques dépassant les limites applicables aux appareils numériques de Classe B prescrites dans le Règlement sur le Brouillage Radioélectrique édicté par le Ministère des Communications du Canada.

CAUTION
Use of controls or adjustments or performance of procedures other than herein may result in hazardous radiation exposure or other unsafe operation.

PHILIPS LIMITED WARRANTY

One (1) Year Free Product Exchange

PHILIPS CONSUMER ELECTRONICS warrants this product against defect in material or workmanship, subject to any conditions set forth as follows:

PROOF OF PURCHASE:

You must have proof of the date of purchase to exchange the product. A sales receipt or other document showing the product, the date that you purchased the product, as well as the authorized retailer included, is considered such proof.

COVERAGE:

Warranty coverage begins the day you buy your product. For a period of one (1) year from the date of purchase, if the product is determined to be defective, Philips will exchange the defective product with a new or renewed product, at its option, at no charge. The replacement product is covered only for the warranty period of the original product. When the warranty on the original product expires, the warranty on all replaced products also expires. When it is necessary for you to ship the product to Philips for exchange, you will pay the shipping cost for shipment to Philips. Philips will pay the shipping costs when returning a product to you.

Note: The exchange model supplied will be the most comparable one in Philips current inventory. Shipping of your product to Philips implies intent to follow the specified requirements of the warranty and exchange program. Product received by Philips cannot be returned. Replacement product can only be sent if all warranty requirements are met. Failure to follow all requirements can result in delay of exchange process.

EXCLUDED FROM WARRANTY COVERAGE

Your warranty does not cover:

- Shipping charges to return defective product.
- Labor charges for installation or setup of the product, adjustment of customer controls on the product, and installation or repair of antenna systems outside of the product.
- Product repair and/or part replacement because of improper installation, connections to improper voltage supply, abuse, neglect, misuse, accident, unauthorized repair or other cause not within the control of Philips.
- Damage occurring to product during shipping when improperly packaged or cost associated with packaging.
- A product that requires modification or adaptation to enable it to operate in any country other than the country for which it was designed, manufactured, approved and/or authorized, or repair of products damaged by these modifications.
- A product used for commercial or institutional purposes (including but not limited to rental purposes).
- Products lost in shipment and no signature verification of receipt can be provided.
- Products sold AS IS or RENEWED.

WHERE WARRANTY EXCHANGE IS AVAILABLE:

Exchange is available in all countries where Philips officially distributes the product. In countries where Philips does not distribute the product, the local Philips organization will attempt to exchange the product, although there may be a delay if the appropriate product is not readily available, or special customs processes are implied.

FOR EXCHANGE IN THE U.S.A., PUERTO RICO, OR U.S. VIRGIN ISLANDS...

Contact Philips Customer Care Center at:
1-800-531-0039

FOR EXCHANGE IN CANADA...

1-800-661-6162 (French Speaking)
1-800-531-0039 (English or Spanish Speaking)

REPLACEMENT AS PROVIDED UNDER THIS WARRANTY IS THE EXCLUSIVE REMEDY OF THE CONSUMER. PHILIPS SHALL NOT BE LIABLE FOR ANY INCIDENTAL OR CONSEQUENTIAL DAMAGES FOR BREACH OF ANY EXPRESS OR IMPLIED WARRANTY ON THIS PRODUCT. EXCEPT TO THE EXTENT PROHIBITED BY APPLICABLE LAW, ANY IMPLIED WARRANTY OF MERCHANTABILITY OR FITNESS FOR A PARTICULAR PURPOSE ON THIS PRODUCT IS LIMITED IN DURATION TO THE DURATION OF THIS WARRANTY.

Some states do not allow the exclusions or limitation of incidental or consequential damages, or allow limitations on how long an implied warranty lasts, so the above limitations or exclusions may not apply to you. In addition, if you enter into a service contract agreement with the PHILIPS partnership within ninety (90) days of the date of sale, the limitation on how long an implied warranty lasts does not apply.

This warranty gives you specific legal rights. You may have other rights which vary from state/province to state/province.

Philips, P.O. Box 520890, Miami, FL 33152 (402) 536-4171

EL6587E001 / 01-04

Supplied Accessories:

- 1 x headphones HE225/HE270
- 1 x EXPANIUM CD-ROM (free musicmatch jukebox software)
- 1 x AA battery door
- 1 x AC-adapter AY3162 (not for all versions,)

CONTROLS (see figure 1)

- ①display
- ② **ESP** selects between the battery powersave mode and **Electronic Skip Protection (ESP)**. ESP prevents playback interruptions caused by shocks.
- ③ **PROG** programs tracks and reviews the program.
- ④ **DISPLAY**MP3/WMA- CD only: selects the track/album information.
- ⑤ **MODE** selects playback options (e.g. **SHUFFLE, REPEAT**).
- ⑥ **OPEN ►**opens the CD lid.
- ⑦ **LINE OUT/**3.5mm headphone jack;
jack to connect the player to another audio input of an additional appliance;
remote control jack (not on all versions).
- ⑧ **VOL -/+**,adjusts the volume.
- ⑨ **DBB**switches the bass enhancement on/off. When pressed for more than 2 seconds, the button switches audible feedback (beep) on/off.

- ⑩ **►II**switches the player on, starts playback and pauses playback.
- /+**MP3/WMA- CD only: selects the next/previous album or skips forward/backward tracks.
- ◀◀ /▶▶**skips and searches tracks backward/forward.
-stops playback/clears programmed tracks/ switches off the set.
- ⑪ **OFF**switches RESUME and HOLD off.
- RESUME**saves the last position played.
- HOLD**locks all buttons (on the set only)
- ⑫AA battery door
- ⑬ **4.5V DC**jack for external power supply.
- ⑭typeplate

Remote Control AY 3785 (not for all versions, see figure 2)



- ① **🔊** 3.5 mm headphone jack.
- ② **►II** switches the set on, starts playback and pauses playback
- ③ **■** stops playback/clears programmed tracks/ switches off the set
- ④ **◀◀ /▶▶** skips and searches forward/backward tracks
- ⑤ **HOLD** locks all button (on the remote control only)
- ⑥ **Volume -/+** adjusts the volume

This set complies with the radio interference requirements of the European Union.

REMOTE CONTROL AY3785

Connecting the remote control (not for all versions)

Use the AY 3785 cord remote control. The buttons on the remote control have the same functions as the corresponding buttons on the set.

- 1 Check your set is switched off.
- 2 Firmly connect the remote control to LINE OUT  on the set.
- 3 Firmly connect the headphones to the plug on the remote control.
- 4 On the remote control, press  to switch on the set and start playback.
- 5 Adjust the volume on the player and your remote control.



Helpful Hints:

- Check that the **HOLD** switch on the remote is adjusted to the **OFF** position if you wish to operate the player using the remote control.

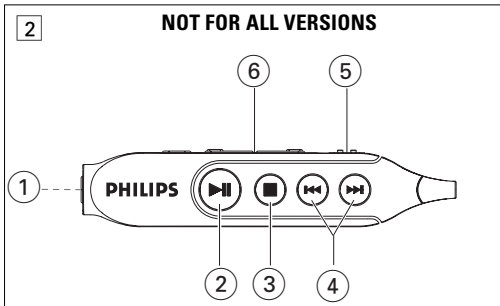

BATTERIES

(supplied or optionally available)

You can use 2 battery sizes with this set:

- alkaline batteries type **AAA (LR03, UM4)** or **AA (LR6, UM3)**.



Helpful Hints:

- Use **AA** batteries to enjoy longer playback time.
- Old and new or different types of batteries should not be combined.
- Remove batteries if they are empty or if the player is not going to be used for a long time.

Inserting AAA (LR03, UM4) or AY 3363 batteries

- 1 Open the battery compartment.
- 2 Insert **AAA** batteries as shown onto the back of the AAA battery door.
- 3 Fit the **AAA** battery-loaded door onto the battery compartment.

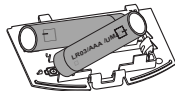



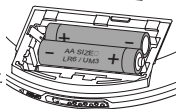

Inserting AA (LR6, UM3) batteries

- 1 Open the battery compartment.
- 2 Insert **AA** batteries as shown into the battery compartment.
- 3 Close the battery compartment with the AA marked door.



Battery indication

The battery level is shown in the display screen as follows:

-  Battery full
-  Battery two-thirds full
-  Battery one-third full
-  Battery dead or empty. When the batteries are dead,  flashes, **Pls replace batteries** is displayed and you will hear beep sounds.

Power Supply

Average playing time of batteries under normal conditions

Battery type

	Audio CD	<i>Power Save</i> MP3-CD/WMA-CD
Alkaline AA	10 hours	20 hours
Alkaline AAA	5 hours	10 hours
Rechargeable	4 hours	6 hours

ECO-PLUS NiMH battery

ECO-PLUS NiMH battery information (for versions supplied with the rechargeable ECO-PLUS NiMH battery AY 3363)

Recharging works only on players supplied with the rechargeable ECO-PLUS NiMH battery AY 3363.

Recharging the ECO-PLUS NiMH battery on board

- 1 Insert the rechargeable ECO-PLUS NiMH battery AY3363.
- 2 Connect the power adapter to the 4.5V DC jack of the player and then to the wall outlet.
→  is pulsing and **CHARGING** is displayed.
- Recharging stops after a maximum of 7 hours, or when you start playback.
- 3 When the battery is fully recharged, **Batt. full** appears in the display.

Helpful Hints:

- During recharging, batteries may get warm.
- When the batteries get too warm, recharging will be interrupted for approximately 30 minutes.
- For proper recharging on board, make sure contacts are clean.
- Only use AY 3363 ECO-PLUS NiMH batteries.

Power Supply / General Information

Handling instructions

- Recharging charged/half-charged batteries will shorten their service life. We therefore recommend that you run out of the rechargeable ECO-PLUS NiMH batteries before recharging them.
- To avoid short-circuiting, keep the batteries from any metallic object.
- If the battery runs out soon after recharging, either its contacts are dirty or its service life has come to an end.

Power adapter (supplied or optionally available)

Only use AY3162 adapter (4.5V/450mA DC, positive pole to the center pin). Any other product may damage the player.

- 1 Make sure local voltage corresponds to the power adapter's voltage.
- 2 Connect the power adapter to the 4.5V DC socket of the player and to the wall socket.



Helpful Hints:

- Always disconnect the adapter when you are not using it.

Batteries contain chemical substances, so they should be disposed of properly.

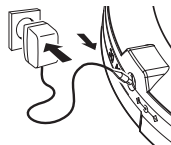

- **Apparatus shall not be exposed to dripping or splashing.**
- **Do not place any sources of danger on the apparatus (e.g. liquid filled objects, lighted candles)**

GENERAL INFORMATION

CD player and CD handling

- Do not touch the lens (A) of the CD player.
- Do not expose the unit, batteries or CDs to humidity, rain, sand or excessive heat (caused by heating equipment or direct sunlight).
- You can clean the CD player with soft, slightly dampened, lint-free cloth. Do not use any cleaning agent as it may have a corrosive effect.
- To clean the CD, wipe it in a straight line from the center toward the edge using soft, lint-free cloth. The cleaning agent may damage the disc! Never write on a CD or attach a sticker to it.
- The lens may cloud over when the unit is moved suddenly from cold to warm surroundings. In that case, playing a CD is not possible. Leave the CD player in a warm environment until the moisture has evaporated.
- Active mobile phones in the vicinity of the CD player may cause malfunctions.
- Avoid dropping the unit as this may cause damage.



ENVIRONMENTAL INFORMATION

- All redundant packing material has been omitted. We have done our utmost to make the packaging easily separable into two mono materials: cardboard (box) and polyethylene (bags, protective foam sheet).
- Your set consists of materials which can be recycled if disassembled by a specialized company. Please observe the local regulations regarding the disposal of packing materials, dead batteries and old equipment.

ABOUT MP3 / WMA

The music compression technology MP3 (MPEG1 Audio Layer 3) and WMA (Windows Media Audio) significantly reduce the digital data of an audio CD while maintaining CD quality sound.

- **Getting MP3/WMA files:** you can either download legal music files from the internet to your computer hard disc, or create such files by converting audio CD files in your computer through appropriate encoder software. (128kbps bit rate or higher is recommended for MP3 files and 96 kbps bit rate for WMA files.)
- **Creating a MP3/WMA CD:** burn the music files from your computer hard disc on a CDR or CDRW using your CD burner. You can use the by-packed EXPANIUM CD-ROM (free **MusicMatch Jukebox** software) to create your own MP3 CD. For more information, please visit **www.musicmatch.com**.



Helpful Hints:

- Make sure that the file names of the MP3 files end with **.mp3** and WMA files end with **.wma**
- Total number of music files and albums: around 350 (with a typical file name length of 20 characters)
- The length of file names affects the number of tracks for playback. With shorter file names, more files can be burned on a disc.

Windows Media Audio® is a registered trademark of Microsoft Corporation.
Musicmatch Inc.® is a registered trademark of Microsoft Corporation

All trademarks are owned by their respective owners.

HEADPHONE / IN-CAR USE

HEADPHONE HE225/HE270

- Connect the supplied headphones to the LINE OUT /  socket of the player.

Helpful Hints:

- LINE OUT/ can also be used to connect this set with your HiFi system. To adjust the sound and volume, use the controls on the connected audio equipment and the CD player.

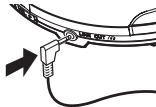

IMPORTANT!

Hearing safety: Do not play your headphones at a high volume. Hearing experts advise that continuous use at a high volume can permanently damage your hearing.

Traffic safety: Do not use headphones while driving a vehicle. It may create hazard and it is illegal in many countries.

IN-CAR USE (connections supplied or optionally available)

Put the set on a horizontal, vibration-free and stable surface. Make sure it is in a safe place, where the set is neither a danger nor an obstacle to the driver and passengers.

PLAYING A CD

This CD player can play all kinds of **Audio Discs** (including CD-Recordables and CD-Rewritables) and **MP3/WMA CDs**. Do not try to play a CD-ROM, CDI, VCD, DVD or computer CDs.

- Push the **OPEN**  slider to open the player.
- Insert an audio CD or a MP3/WMA CD, printed side up, by pressing the CD onto the hub.
- Close the player by pressing the lid down.
- Press **▶||** to switch the player on and start playback.
→ For an audio CD: the current track number, **CDA-Track** and elapsed playing time are displayed.
For an MP/WMA CD: the filename scrolls, current album/track number and elapsed playing time are displayed.

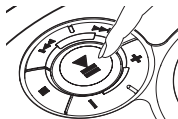
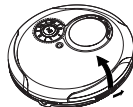

Helpful Hints:

- Track type is indicated by the cursor  at WMA, MP3 and CD respectively.

To pause playback

- Press **▶||**.
→ The elapsed playing time flashes.
- Press **▶||** again to continue playback.



PLAYING A CD, VOLUME AND SOUND

To stop playback

- Press **■**.
→ For an audio CD, the total number of tracks and the total playing time are displayed. For a MP/WMA-CD, the total numbers of tracks and albums are displayed respectively.
- Press **■** again to switch off the player.
- To remove the CD, hold it by its edge and press the hub gently while lifting the CD.



✓ Helpful Hints:

- If there is no activity, the set will automatically switch off after 90 seconds.

Volume adjustment

- Adjust the volume by using **VOL +/-** on the CD player or the slider on your headphone.

Bass adjustment

There are three DBB (Dynamic Bass Boost) options:

- Off: no bass enhancement
 - **DBB 1** : moderate bass enhancement
 - **DBB 2** : strong bass enhancement
- Press **DBB** once or more to select your option.
→ **DBB 1 2** appears if DBB activated.



Track and album information (for MP3/WMA CDs)

During playback, toggle **DISPLAY** to view information about your tracks/albums.

- Press **DISPLAY** once or more to see the following:
 - **Album** : the album's folder name,
 - **Artist** : the artist's name (if ID3 tag available)
 - **Title** : the track title (if ID3 tag available), track type and elapsed playing time.
 - **File name** : the track's file name.
- The selected information is shown, along with the current album/track number and elapsed time.

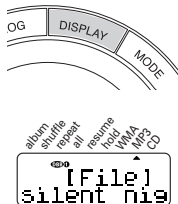

✓ Helpful Hints:

- For audio CDs, (Audio-Track) will be shown when you press **DISPLAY**.
- The ID3 tag is part of a MP3 file. It contains various track information, such as the track's title or the artist's name. Try to get complete ID3 tag information with your encoder software when burning a MP3/WMA-CD.

The set complies with the FCC-Rules, Part 15 and with 21 CFR 1040.10. Operation is subject to the following two conditions:

- 1. This device may not cause harmful interference, and**
- 2. This device must accept any interference received, including interference that may cause undesired operation.**

SELECTING A TRACK AND SEARCHING

Selecting and searching on all discs

Selecting a track during playback

- Briefly press **◀◀** or **▶▶** once or several times to skip to the beginning of the current, previous or subsequent track.
→ Playback starts with the selected track.

Searching for a passage during playback

- 1 Press and hold **◀◀** or **▶▶** to find a particular passage in a backward or forward direction.
→ Searching starts while playback continues at low volume. After 2 seconds the search speeds up.
- 2 Release the button when you reach the desired passage.
→ Playback continues from this position.

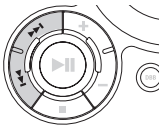

Selecting albums and tracks on MP3/WMA CDs

Selecting an album during playback

- Briefly press **-** or **+** once or several times to skip to the first track of the current, previous or subsequent album.
→ The first track of the selected album plays.

Selecting a track during playback

- 1 Keep **-** or **+** pressed to skip quickly to previous or subsequent MP tracks.
→ Skipping starts and speeds up after 5 seconds.
- 2 Release the button at desired track.
→ Playback continues with the selected track.



Helpful Hints:

- When a program is playing, use of the **-** or **+** keys are void.

PROGRAMMING TRACKS

You can store up to 50 tracks to play in a program. When playing a MP3/WMA-CD, you can select the 50 tracks from different albums. A single track may be stored more than once in the program.

- 1 Stop playback.
→ The total numbers of albums/tracks are displayed (for MP3/WMA CDs only). The total number of tracks and the total playing time are displayed (for an audio CD).
- 2 Select a track by pressing **◀◀** / **▶▶** or **-** / **+** (**-** or **+** for MP3/WMA CDs only).
- 3 Press **PROG** to store the track.
→ **Added to Program** appears briefly. **prog** appears. The track number programmed, as well as P plus the total number of stored tracks, are displayed.
- 4 Select and store all desired tracks in this way.
- 5 Press **▶▶** to start playback of your selected tracks.
→ **prog** is displayed and playback starts.

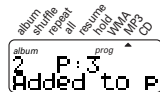
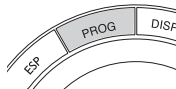

To review the program

- 1 Press **■** to stop the playback.
- 2 Press and hold **PROG** for more than 2 seconds.
→ The display lists all the stored tracks in sequence, and **program review**.



Helpful Hints:

- **select track** appears if you press **PROG** and there is no track selected.
- **program full** appears if you try to store more than 50 tracks.

PROGRAMMING TRACKS, RESUME

To clear the program

- Press **■** :
 - Once, if in the stop position
 - Twice, during playback.
- **Program cleared** is displayed and **Prog** disappears.

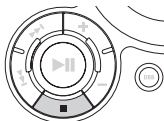

✓ Helpful Hints:

– The program will also be cleared if the power supply is interrupted, or if the player lid is opened, or if the set switches off automatically.

Resume

You can store the last position played. When restarting, playback will continue from where you have stopped (RESUME). Use the OFF-RESUME-HOLD slider for these functions.

RESUME - continuing from where you have stopped

- 1 Switch the slider to **RESUME** during playback to activate **RESUME**.
 - ▲ appears at **resume**.
 - 2 Press **STOP ■** whenever you want to stop playback.
 - 3 Press **▶||** whenever you want to resume playback.
 - playback continues from where you have stopped.
- To deactivate RESUME, switch the slider to **OFF**.
 - ▲ disappears from **resume**.

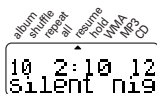

SELECTING DIFFERENT PLAYING POSSIBILITIES – MODE

Your selected play mode is indicated by one or more ▲ cursors.

- 1 Press **MODE** once or more during playback to activate one of the following.
 - **shuffle** : All tracks of the disc play in random order once.
 - **shuffle repeat all** : All tracks of the disc play in random order repeatedly.
 - **repeat** : The current track plays repeatedly.
 - **repeat all** : All tracks of the disc play repeatedly.
 - **album shuffle** (for MP3/WMA CDs only): All tracks of the current album play in random order once.
 - **album shuffle repeat all** (for MP3/WMA CDs only) : All tracks of the current album play in random order repeatedly.
 - **album repeat all** (for MP3/WMA CDs only) : All tracks of the current album play repeatedly.
- Playback starts in the selected mode after 2 seconds.

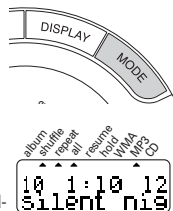

- 2 To return to normal playback, press **MODE** repeatedly until the mode cursors disappear.

ESP, POWER SAVE MODE

With a conventional portable CD player, you might have experienced that music stopped (e.g. when you were jogging). The **Electronic Skip Protection** prevents playback interruption caused by light vibrations and shocks. Continuous playback is ensured. However, ESP does not prevent playback interruptions during vigorous running. **It also does not protect the unit against any damage caused by dropping!**

The power save mode helps to extend battery service life for longer playback.

- Press **ESP** once or twice during playback.
→ ESP appears when shock protection is activated
- To deactivate the shock protection and enter the power save mode, press **ESP**.
→ ESP disappears and **Powersaving** appears.

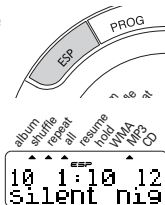

200 SEC MAGIC ELECTRONIC SKIP PROTECTION !

Average playing times when ESP skip protection activated :

Seconds	track type
200	WMA (64kbps)
100	MP3 (128kbps)
45	Audio CD

HOLD, BEEP

HOLD- locking all buttons

This player offers a double lock function to prevent buttons from being accidentally pressed and activated. You can choose to lock all buttons on either your set, remote control or even both! Simply adjust the respective **HOLD** slider to **HOLD** on or off position as desired. For example:

- Switch the **OFF•RESUME•HOLD** slider to **HOLD** to activate HOLD on the set.
→ **▲** appears at **hold**. All buttons are locked and **Hold** is shown when you press any button on the set. If the set is switched off, Hold appears only when **▶||** is pressed.
- To deactivate HOLD, switch the slider to **OFF**.
→ All the buttons are unlocked.



Helpful Hints:

- If you deactivate **HOLD** by switching the slider on the set to **RESUME**, you will be activating the **RESUME** function.
- If you have activated the **HOLD** command on the remote control, no **Hold** indication appears.

Beep

A beep confirms that you have pressed a button or that the batteries are empty.

- Press **DBB** for more than 2 seconds to toggle between either beep on or off.
→ **Beep** appears if beep activated.
→ **No Beep** if beep deactivated.

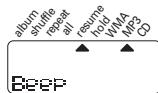

Helpful Hints:

- *Beep is on as the default setting.*

TROUBLESHOOTING

WARNING: Under no circumstances should you try to repair the set yourself as this will invalidate the warranty. If a fault occurs, first check the points listed before taking the unit for repair. If you are unable to solve a problem by following these hints, consult your dealer or service center.

The CD player has no power, or playback does not start

- Check that your batteries are not empty, that they are inserted correctly, that the contact pins are clean.
- Your adapter connection may be loose. Connect it securely.
- For in-car use, check that the car ignition is on. Also check the player's batteries.

The indication **Pls insert CD** or **No audio file is displayed**

- Check that the CD is clean and correctly inserted (label-side upward).
- If your lens have steamed up, wait a few minutes until the lens clear up.
- CD-RW (CD-R) was not recorded properly. Use FINALIZE on your CD-recorder.

The indication **Hold is on** and/or there is no reaction to controls

- If HOLD is activated, then deactivate it.
- Electrostatic discharge. Disconnect power or remove batteries for a few seconds.

Music files do not play

- Check that the file names of MP3/WMA files end with .mp3 or .wma.

TROUBLESHOOTING

Some directories missing on MP3/WMA CDs

- Check that the total number of files and albums on your MP3/WMA CDs does not exceed 350.
- Only albums with MP3/WMA files are shown.

The CD skips tracks

- The CD is damaged or dirty. Replace or clean the CD.
- Resume, shuffle or program is active. Switch off whichever is on.

Music skips or popping sounds when you play a MP3/WMA track

- Play the music file in your computer. If the problem remains, encode the audio track again and make a new CD.

No sound or bad sound quality

- Playback on pause. Press ►||.
- Loose, wrong or dirty connections. Check and clean connections.
- Volume might not be appropriately adjusted. Adjust the volume.
- Strong magnetic fields. Check the player's position and connections. Also keep away from active mobile phones.

CAUTION

Use of controls or adjustments or performance of procedures other than herein may result in hazardous radiation exposure or other unsafe operation.

Free Manuals Download Website

<http://myh66.com>

<http://usermanuals.us>

<http://www.somanuals.com>

<http://www.4manuals.cc>

<http://www.manual-lib.com>

<http://www.404manual.com>

<http://www.luxmanual.com>

<http://aubethermostatmanual.com>

Golf course search by state

<http://golfingnear.com>

Email search by domain

<http://emailbydomain.com>

Auto manuals search

<http://auto.somanuals.com>

TV manuals search

<http://tv.somanuals.com>