

Leadership enterprise server with significantly lower cost of ownership in a highly available and expandable, rack-dense, 1U dual-socket server



Product Guide

March 2009

IBM System x3550 M2

Product Overview

Outstanding innovation in only 1U

Suggested Uses: All sectors requiring highly available, energy-efficient, rack-optimized solution for physical and virtual intensive commercial environments like eBusiness/eCommerce, collaboration, virtualization, database, and enterprise resource planning applications.

Your challenge is to do more with less—serve more Web pages, handle more secure connections, support more e-mail users. You need to reduce the costs of doing business and improve the service you deliver to your customers while lower your overall risk. The **dual-socket IBM® System x3550 M2** can reduce your costs with its new energy smart design. It can improve service with reduced operational complexity and increased management functionality. It will lower your IT risk with the resiliency that comes from no single point of failure. And like all IBM servers, the x3550 M2 offers you the trust that comes from the IBM global reach, service and support.

The x3550 M2 is not simply an upgrade to a previous server. It is one of our new generation of X-Architecture servers. It is a game-changing, completely redesigned rack server using significantly less power with unified systems management tools, leadership reliability, availability, serviceability features and broad systems flexibility housed in a compact 1U mechanical package.

The x3550 M2 features **Intel® Xeon® 5500 Series Processors** and either **8MB** or **4MB** of shared **cache**, to help provide you with the computing power you need to match your business needs and growth. This new line of Intel processors delivers unprecedented intelligent performance with features like adaptive performance for applications and environments, turbo boost and hyper-threading technology, and integrated power gates and automated power management.

The x3550M2 uses up to **16 DIMMs** with **128GB** of **registered 1333MHz DDR3** memory with **Chipkill™ ECC** (Error Checking and Correcting) protection—for high performance and reliability. For even higher levels of availability, the x3550M2 also offers online memory mirroring. **Up to 4** integrated high-speed **Gigabit Ethernet** controllers with **TOE** (TCP Offload Engine) and **Jumbo Frame** support are available, as are two high-performance adapter slots (**PCIe x16**). The x3550M2 offers an optional **embedded hypervisor** to manage your virtual workloads.

The x3550 M2 offers a choice of up to six high-performance hot-swap hard disk drives with an internal storage capacity of 1.8TB (**six 2.5-inch hot-swap Serial-Attached SCSI (SAS)** or **SATA HDDs**). Optional solid-state drives are also available to keep power low and improve resiliency and offer up to **300GB** of storage. The server supports a choice of four IBM ServeRAID® storage controllers which provide broad levels of **hardware-based RAID solutions**. The ultradense **1U** form factor allows businesses to increase their computing power and spread their workload without outgrowing their current data center. Up to **42** of these **1U** servers can be installed in a single 42U rack, for a total of up to **84** processors and **336** processor cores, offering tremendous deployment flexibility. Optional Advanced Connectivity Technology (**ACT**) interconnect cabling reduces cable clutter and cost and minimizes installation time when interconnecting many rack-mounted servers.

Standard in the x3550 M2 is the Integrated Management Module (IMM) that enables the user to manage and control the server easily—both locally and remotely. In conjunction with the IMM, the x3550 M2 comes with an **altitude sensor (altimeter)**, which **governs fan rotation** based on altitude to help lower your energy consumption. The IMM offers a high level of manageability that is designed to keep costs down and the system up—even when network usage increases. IBM's innovative pop-out/drop-down **light path diagnostics** panel enables quick servicing of the system if a problem develops. These advanced features help maximize network availability by increasing uptime, as do hot **simple-swap solid-state drives**; **hot-swap/redundant SAS** or **SATA HDDs**, redundant ultra-efficient **power supplies** and **fans**; **Active Memory™**; integrated **RAID**; **temperature-controlled fans** with **Calibrated Vectored Cooling™**; **IPMI 2.0** support, including **highly secure remote power control** and **Serial over LAN**; as well as **text-console redirect over LAN**.

Another improvement with the new generation of X-Architecture is the replacement of old BIOS

CONTENTS

Product Overview	1
Selling Features	2
Key Features	4
Key Options	12
x3550 M2 Images	14
x3550 M2 Specifications	15
The Bottom Line	17
Server Comparison	18
For More Information	19
Legal Information	19

with a new generation **Unified Extensible Firmware Interface (UEFI)**. UEFI provides a more intuitive user interface and understandable event logs and better management.

With the inclusion of unique IBM service and support features such as the IMM, light path diagnostics, **IBM Systems Director 6.1**, **IBM Systems Director Active Energy Manager**, **IBM ServerGuide™** and support for the optional Virtual Media Key for remote presence capability, the x3550 M2 is designed for superior uptime.

If you need highly manageable, dual-socket/multi-core computing power in a rack-dense package, the x3550 M2 is the ideal system.

Selling Features



Price/Performance

The x3550 M2 offers numerous features to boost performance and reduce costs:

- Up to **two 4-core** Xeon 5500 Series processors and **8MB** or 4MB of shared cache per processor, offer superior performance capable of tackling the toughest jobs. **64-bit extensions** provide the flexibility to run 32-bit and 64-bit applications concurrently. Xeon 5500 series processors offer up to 225% better performance than the previous-generation 5400 series processors and up to 900% better performance than the single-core processors of a few years ago that you may still be using.
- **Low-voltage processors** draw less energy and produce less waste heat than high-voltage processors, thus helping to reduce data center energy costs. Some **4-core** Xeon 5500 Series processors use only **60W**. This is less than half the wattage consumed by older 130W processors.
- Sixteen DIMMs of ultra-fast **registered 1333MHz DDR3 ECC** memory with **Chipkill¹** error protection (using x8 DIMMS) provides speed, high availability, and a memory capacity of up to **128GB**.
- Optional **32GB and 50GB solid-state drives (SSD)** use only **2W** of power per drive, vs. **9-10W** for 2.5-inch HDDs. This is as much as **80%** less power than a 2.5-inch HDD would use (with a corresponding reduction in heat output).
- The x3550 M2 is a leader in server resiliency. With hot-swap power supplies, fans, and storage, the x3550 M2 has **no single point of failure**.
- The altimeter works in conjunction with IMM to **govern fan rotation**, which can help **save money at lower altitudes** because the fans do not have to spin at high speed.
- Two **high-speed PCIe x16 adapters (Gen 2) slots** offer investment protection by supporting high-performance adapters, such as 10Gb Ethernet, Fibre Channel and InfiniBand™ cards, none of which will run in older 33MHz and 66MHz conventional PCI slots.
- Integrated **ServeRAID-BR10i** provides **RAID-0/1/10** support without consuming a valuable adapter slot. RAID-0/1/10 offers improved disk performance via data striping; RAID-1 offers disk mirroring for high availability, and RAID-10 combines the benefits of speed and availability. The x3550 M2 also supports full **RAID-0/1/10/1E/5/6** using the optional ServeRAID-MR10i card. It also offers higher performance, due to the **256MB battery-backed onboard cache**.
- Up to **six 2.5-inch hot-swap SAS** hard disk drives offer high-performance with high availability. The SAS controller provides full-duplex (**bi-directional 300MBps**) data transfers for SAS drives.
- The integrated **dual Gigabit Ethernet** controllers with **IPMI 2.0** support provide high-speed network communications. **Jumbo Frames** offer higher efficiency transfers for large data packets. Two more NICS can be supported on the planar with an additional Dual Port GbE daughter card.
- The TCP Offload Engine (**TOE**) feature offers higher performance for TCP/IP traffic, with less overhead on the system processor.
- A **high degree of device integration**—including SAS/SATA or SSD, multiple ServeRAID options, up to four Gigabit Ethernet ports, systems management and video controllers—lowers costs and frees up valuable adapter slots.

Flexibility

The x3550 M2 has the ability to grow with your application requirements, thanks to

- A choice of **quad-core** or dual-core processors with **1.86 to 2.93GHz** clock rates, up to **6.4 gigatransfers per second**, Turbo Boost and Hyper-threading technology, and **60W to 95W** maximum power draw.
- Up to **128GB** of high-speed fully-buffered DDR3 system memory.

¹ All models require Chipkill-enabled DIMMs (provided standard) for Chipkill protection.

-
- **Two available high-performance PCIe x16** adapter slots in all models. Optionally, if desired, the riser card containing one of the PCIe slots can be exchanged for a riser containing a **PCI-X/133** adapter slot.
 - Installing the **ServeRAID MR10i** option upgrades the basic **ServeRAID functionality** controller with **256MB** of low-cost, battery-backed cache to enable even higher-performance hardware RAID support, and allows the x3550 M2 to offer **six** RAID levels: **RAID-0, 1, 10, 1E, 5** and **6**. The optional **ServeRAID MR10M** controller supports up to **four** IBM System Storage™ **EXP3000** expansion units containing up to **48** SAS HDDs and **14.4TB** of external storage.
 - The **four USB 2.0** ports (two front, two rear) are up to **40X** faster² than older **USB 1.1** ports. This provides speedy access to external HDDs (non-arrayed), optical drives, tape drives, and other USB devices. Two ports are on the front of the unit and two are on the back.
 - A choice of up to **six 2.5-inch hot-swap SAS/SATA** HDDs or solid-state drives or eight 2.5-inch drives and one internal tape drive offer a variety of storage options. The SAS and SATA models provide a maximum of **1.8GB** of internal **hot-swap** storage.
 - Alternatively, iSCSI or Fibre Channel-attached storage can be attached using IBM **System Storage™** servers.
-

Manageability

Powerful systems management features simplify local and remote management of the x3550 M2:

- The x3550 M2 includes the **IMM** to monitor server availability, perform Predictive Failure Analysis, etc., and trigger IBM Systems Director alerts. The IMM enables service personnel to use sophisticated diagnostic tools, such as light path diagnostics, to resolve problems quickly.
 - Integrated industry-standard Unified Extensible Firmware Interface (**UEFI**) next-generation BIOS. New capabilities include:
 - Human readable event logs – no more beep codes
 - Complete setup solution by allowing adapter configuration function to be moved into UEFI
 - Complete out-of-band coverage by Advance Settings Utility to simplify remote setup
 - Integrated **Trusted Platform Module (TPM) 1.2** support.
 - Integrated **IPMI 2.0** support alerts IBM Systems Director to anomalous environmental factors, such as voltage and thermal conditions. It also supports **highly secure remote power control** using data encryption.
 - **IBM Systems Director Active Energy Manager™**, an IBM-exclusive, is designed to take advantage of new system power management features, by providing power monitoring and power capping features.
 - **Text Console Redirection** support allows the administrator to remotely view x3550 M2 text messages over Serial or LAN.
 - The completely redesigned **IBM Systems Director** is included for proactive systems management. IBM Systems Director comes with a portfolio of tools, including *Management Processor Assistant, Rack Manager, RAID Manager, Update Assistant* and *Software Distribution*. In addition, IBM Systems Director offers extended systems management tools for additional server management and increased availability. When a problem is encountered, IBM Systems Director can issue administrator alerts via e-mail, pager, and other methods.
 - An optional Virtual Media Key provides additional systems management capabilities, including *Web-based out-of-band control; virtual floppy and optical drive support; Windows “blue screen” error capture; LDAP and SSL support; and remote redirection of PCI video, text, keyboard and mouse*. And it does all this without consuming a valuable adapter slot.
-

Availability and Serviceability

The x3550 M2 provides many features to simplify serviceability and increase system uptime:

- x3550 M2 servers use **Chipkill** ECC memory protection³. Chipkill memory is up to **16X** better than standard ECC memory at correcting memory errors. This can help reduce downtime caused by memory errors.
- The x3550 M2 offers selectable **memory mirroring** for redundancy in the event of a non-correctable memory failure
- **Toolless cover removal** provides easy access to upgrades and serviceable parts. Similarly,

² Data transfer rates may be less than the maximum possible.

³ Chipkill protection is supported with x4 DDR-3 DIMMs, but not x8 DIMMs.

Leadership enterprise server with significantly lower cost of ownership in a highly available and expandable, rack-dense, 1U dual-socket server



the Virtual Media Key and the **ServeRAID-BR10i** controller can be installed and replaced without tools. This means less time (and therefore less money) spent servicing the x3550 M2. Similarly, **hot-swap/redundant HDDs, fans and power supplies**, as well as **online mirrored memory**, mean greater system uptime while these components are being serviced.

- New **toolless slides** ship with the server, together with a **Cable Management Arm (CMA)**, that allows the rack server to easily slide into place
- **IBM Thermal Diagnostics** allows the administrator to evaluate thermal data on the server without taking the hardware offline. This can provide greater server uptime.
- The **drop-down light path diagnostics panel** and individual light path LEDs quickly lead the technician to failed (or failing) components. This simplifies servicing, speeds up problem resolution and helps improve network availability.
- **Integrated RAID-1 disk mirroring** and **RAID-10 striped mirrored arrays** standard enable the server to keep operating in the event of a failure of any one drive.
- **IPMI 2.0** supports highly secure remote system power control using data encryption. This allows an administrator to restart a server without having to visit it in person, saving travel time and getting the server back up and running quickly and securely. It also adds new features to those provided by IPMI 1.5, including **VLAN** support, **Serial over LAN**, enhanced authentication and encryption algorithms (**RMCP+**, **SHA-1**, **AES**) and a **firmware firewall**.
- **Altitude- and temperature-controlled fans** adjust to compensate for changing thermal characteristics. At the lower speeds they draw less power and suffer less wear. Equally important in a crowded data center, temperature-controlled fans produce less ambient noise in the data center than if they were constantly running at full speed.
- The **three-year (parts and labor) limited onsite warranty⁴** helps afford you peace of mind and greater investment protection than a one-year warranty does.

Key Features

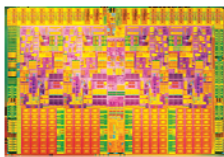

High-Performance Xeon 5500 Series Processors

The x3550 M2 supports up to two high-performance Intel Xeon processors, allowing you to upgrade to a second processor as your business needs require. The x3550 M2 offers a choice of processor clock rates, memory access speeds and energy efficiency, including:

- **95W quad-core** Xeon 5500 Series Processor advanced performance models **X5570**, **X5560**, or **X5550** at 2.93, 2.8, 2.66GHz respectively running **6.4GT** (gigatransfers/second) with **8MB** of L3 processor cache, **1333MHz** memory access, and Intel Turbo Boost technology.
- **80W quad-core** Xeon 5500 Series Processor standard performance models **E5540**, **E5530**, or **E5520** at 2.53, 2.4, 2.26GHz respectively running **5.8GT** with **8MB** of L3 processor cache, **1066MHz** memory access, and Intel Turbo Boost technology.
- **80W quad-core** Xeon 5500 Series Processor basic models **E5506** and **E5504** at 2.13 and 2.0GHz running **4.8GT** with **4MB** of L3 processor cache and **800MHz** memory access.
- **60W quad-core** Xeon 5500 Series Processor low-voltage models **5520**, **L5506** at 2.26, 2.13GHz respectively running **5.8GT** and **4.8GT** with **8MB** and **4MB** of L3 processor cache, **1066MHz** memory access, and Turbo Boost technology.
- **80W dual-core** Xeon 5500 Series Processor model **E5502** at 1.86GHz running **4.8GT** with **4MB** of L3 processor cache and **800MHz** memory access.

With the Xeon 5500 Series processors, Intel has diverged from its traditional Symmetric Multiprocessing (SMP) architecture to a Non-Uniform Memory Access (NUMA) architecture. The Xeon 5500 processors are connected through a serial coherency link called QuickPath Interconnect (QPI). QPI is capable of 6.4, 5.6 or 4.8 GT/s (gigatransfers per second), depending on the processor model.

Dual-core Xeon processors contain **two complete processor cores**; **quad-core** processors, similarly, contain **four** cores. Some processors contain one **unified** cache **shared** by all cores, while other processors have multiple **independent** caches (one per pair of cores). The shared cache is dynamically allocated between the cores as needed. The multiple cores appear to software as multiple physical processors. The dual-core processors offer considerably higher performance than a same-speed Xeon processor with a single core. Likewise, quad-core processors offer considerably higher performance than a same-speed Xeon processor with dual cores.

Turbo Boost Technology dynamically turns off unused processor cores and increases the clock speed of the cores in use, by up to two model frequencies. For example, with **three** cores active,

⁴ For terms and conditions or copies of the IBM Statement of Limited Warranty, call 800-772-2227 in the U.S. In Canada call 800-426-2255. Telephone support may be subject to additional charges. For warranties including onsite labor, a technician is sent after IBM attempts to resolve the problem remotely. International warranty service is available in any country in which this product is sold.

a **2.26GHz** processor can run the cores at **2.4GHz**. With only **one** or **two** cores active, the same processor can run those cores at **2.53GHz**. Similarly, a **2.93GHz** processor can run at **3.06GHz** or even **3.33GHz**. When the cores are needed again, they are dynamically turned back on and the processor frequency is adjusted accordingly.

Intel Extended Memory 64 Technology (EM64T) 64-bit extensions allow the Xeon processor to use large memory addressing when running with a 64-bit operating system. This in turn lets individual software processes directly access more than 4GB of RAM, which was the limit of 32-bit addressing. This can result in much higher performance for certain kinds of programs, such as database management and CAD. Additional registers and instructions (SSE3) can further boost performance for applications written to use them. Contact your software provider to determine their software support for EM64T.

Intelligent Power Capability powers individual processor elements on and off as needed, to reduce power draw.

Execute Disable Bit functionality can help prevent certain classes of malicious buffer overflow attacks when combined with a supporting operating system.

DDR-3 Registered Memory with Chipkill ECC Protection

The x3550 M2 ships with registered double data rate III (DDR-3) memory and provides Active Memory features, including advanced **Chipkill** memory protection (optionally), for **up to 16X** better error correction than standard ECC memory. In addition to offering better performance than DDR-2 or fully-buffered memory, DDR-3 memory also uses less energy. DDR-2 memory already offered up to 37% lower energy use than fully buffered memory. Now, a generation later, DDR-3 memory is even more efficient, using **22% less energy** than DDR-2 memory.

The x3550 M2 supports up to **128GB** of memory in **sixteen** DIMM slots. Redesign in the architecture of the Xeon 5500 series processors bring radical changes in the way memory works in these servers. For example, the Xeon 5500 series processor **integrates the memory controller inside the processor**, resulting in two memory controllers in a 2-socket system. Each memory controller has three memory channels. Depending on the type of memory, population of memory, and processor model, the memory may be clocked at **1333MHz**, **1066MHz** or **800MHz**.

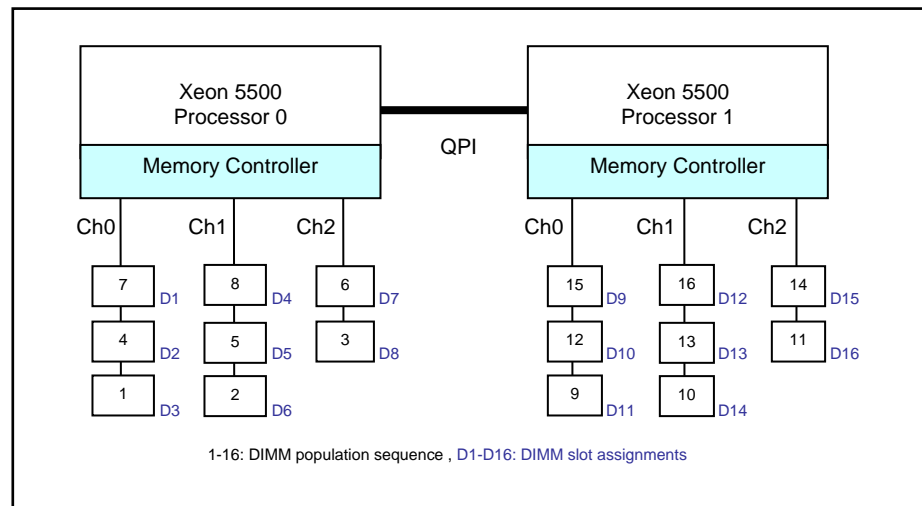

Note: If only one processor is installed, only the first eight DIMM slots can be used. Adding a second processor not only doubles the amount of memory available for use, but also doubles the number of memory controllers, thus doubling the system memory bandwidth. If you add a second processor, but no additional memory for the second processor, the second processor has to access the memory from the first processor "remotely," resulting in longer latencies and lower performance. The latency to access remote memory is almost **75% higher** than local memory access. So, the goal should be to always populate both processors with memory.

The **X55xx** models support up to 1333MHz memory clock speed, while the **E55xx**-and-up and **L55xx**-and-up models support up to 1066MHz clock speed, and the **E550x** models support 800MHz clock speed. Using 1333MHz memory (where supported) versus 1066MHz offers up to **9%** better performance, while 1066MHz memory produces up to **28%** better performance than 800MHz memory.

Xeon 5550 series processors access memory with almost **50% lower latency** than the previous generation 5400 series processors. That can result in faster processing of latency-sensitive workloads.

This new processor design comes with some trade-offs in memory capacity, performance, and cost: For example, **greater memory capacity** comes with **lower memory speed**. Alternatively, it is possible to achieve the **same memory capacity at lower cost** but at a **lower memory speed**.

Regardless of memory *speed*, the Xeon 5500 platform represents a significant improvement in memory *bandwidth* over the previous Xeon 5400 platform. At 1333MHz, the improvement is almost **500%** over the previous generation. This huge improvement is mainly due to the dual integrated memory controllers and faster DDR-3 1333MHz memory. Throughput at 800MHz is **25 gigabytes per second** (GBps); at 1066MHz it's **32GBps**; and at 1333MHz it's **35GBps**. This improvement translates into improved application performance and scalability.

Memory interleaving refers to how physical memory is interleaved across the physical DIMMs. A balanced system provides the best interleaving. A Xeon 5500 processor-based system is balanced when all memory channels on a socket have the same amount of memory.

A memory rank is simply a segment of memory that is addressed by a specific address bit. DIMMs typically have 1, 2 or 4 memory ranks, as indicated by their size designation.

- A typical memory DIMM description is **2GB 4Rx8 DIMM**
- The 4R designator is the rank count for this particular DIMM (R for rank = 4)
- The x8 designator is the data width of the rank

It is important to ensure that DIMMs with appropriate number of ranks are populated in each channel for optimal performance. Whenever possible, **it is recommended to use dual-rank DIMMs** in the system. Dual-rank DIMMs offer better interleaving and hence better performance than single-rank DIMMs. For instance, a system populated with six 2GB *dual-rank* DIMMs outperforms a system populated with six 2GB *single-rank* DIMMs by **7%** for SPECjbb2005. Dual-rank DIMMs are also better than quad-rank DIMMs because **quad-rank DIMMs will cause the memory speed to be down-clocked**.

Another important guideline is to populate equivalent ranks per channel. For instance, **mixing one single-rank DIMM and one dual-rank DIMM in a channel should be avoided**.

Note: It is important to ensure that all three memory channels in each processor are populated. The relative memory bandwidth decreases as the number of channels populated decreases. This is because the bandwidth of all the memory channels is utilized to support the capability of the processor. So, as the channels are decreased, the burden to support the requisite bandwidth is increased on the remaining channels, causing them to become a bottleneck.

For increased availability, the x3550 M2 offers an additional (but mutually exclusive) level of IBM Active Memory protection: online **memory mirroring**.

Memory mirroring works much like disk mirroring. The total memory is divided into two channels. Data is *written concurrently to both channels*. If a DIMM fails in one of the DIMMs in the primary channel, it is instantly disabled and the mirrored (backup) memory in the other channel becomes active (primary) until the failing DIMM is replaced. One-half of total memory is available for use with mirroring enabled. (**Note:** Due to the double writes to memory, performance is affected.)

Mirroring is handled at the hardware level; no operating system support is required.

DDR-3 memory is available in **1GB, 2GB, 4GB** and **8GB** DIMMs. DIMMs are installed individually (not in pairs).

Drive Bays



The x3550 M2 contains **six** drive bays in all. Hot-swap drives may be inserted or removed through the front of the server without powering off the system. Simple-swap solid-state drives can be inserted or removed through the front of the server as well; however, the system power must first be turned off.

For additional storage, a direct-attach, NAS or SAN external expansion option can be added, using an optional controller.

A **24X/24X/24X/8X**⁵ speed (ultraslim, 0.5") CD-RW/DVD-ROM Combo drive with an IDE interface ships standard in all x3550 M2 servers. No diskette drive is supplied with any model; an external USB floppy drive may be used, if needed.

Disk Controllers

All SAS-equipped x3550 M2 models include an integrated hardware based **ServeRAID-BR10i SAS/SATA controller**. This controller supports up to **six** internal SAS, SATA or solid-state drives.

⁵ Variable read rate. Actual playback speed varies and is often less than the maximum possible.

The integrated **ServeRAID-BR10i** controller offers *hardware RAID-0/1/1E* support. The controller provides data transfer speeds of up to **3Gbps⁶** per SAS port on an 8-lane 2.5 Gbps PCIe card. It connects to both SAS and SATA SSDs and tape drives.

The x3550 M2 also supports full **RAID-0/1/10/1E/5/6** support using the optional ServeRAID-MR10i card. It also offers higher performance, due to the **256MB battery-backed onboard cache**.

The x3550 M2 also supports hardware based full disk encryption with **RAID-0/1/10/1E/5/6** support using the optional ServeRAID-MR10is card.

For external storage, the ServeRAID MR10M controller enables connection to up to four IBM System Storage EXP3000 SAS expansion units (48 HDDs total). It provides RAID-0/1/10/5/50 support and 256MB of onboard cache

Additional external storage is available.

HDD Storage Capacity

The x3550 M2 offers a flexibility with up to six (6) 2.5" HDD bays; optimal price/performance disk drives that provide ultimate drive density and allow you to scale up as your business grows.

- Support for six 300GB **hot swap SAS** HDD — 1.8TB total internal SAS storage
- Support for six 300GB **hot swap SATA** HDD — 1.8TB total internal SATA storage (500GB SATA HDD planned 3Q09)
- Support for solid-state drives (SSDs); 32GB or 50GB capacity deployable in all 6 HDD bays
 - 32GB SSD** – Slim FF (2.5") HS HDD (SATA interface) or Simple Swap HDD
 - 50GB SSD** – Slim FF (2.5") High IOPS Hot Swap HDD (SATA Interface) or Simple Swap HDD
- **High IO Performance**
 - Up to 8X IOPS more than HDD (67/33% Read/Write OLTP transaction base mix)
 - Optimized for heavy mix of Read and Write operations such as transaction processing
 - Media Streaming, Surveillance, File Copy, Logging, Backup/Recovery, Business Intelligence
- **Lower Cost IOPS Performance**
 - Yields better \$/IOPS: lower capacity (GB) required to achieve higher IOPS
 - Utilizes Less power and heat than conventional disk drive
- **Superior Uptime**
 - 3X the availability of mechanical drives with RAID-1
 - No moving parts to fail
 - Enterprise wear leveling to extend life even further
- **Flexible Deployment with full OS Support**
 - Traditional HDD form factor offerings
 - Supports Linux, Windows and VMware

2-5-inch drives not only require less space than 3.5-inch drives, they *weigh less, consume half the power, produce less noise, seek faster, and offer increased reliability*.

The hot-swap SAS drives use the Converged Tray for interchangeability with other IBM System x[®] systems. If you need more storage space, terabyte capacities are possible with external direct-attach, NAS and SAN solutions.

High-Performance Adapter Slots

The x3550 M2 provides **two x16** ("by 16") **8GBps PCIe (PCI Express) Gen 2** high performance I/O slots help double the performance vs. the previous-generation x3550 for added long-term investment protection. Each is capable of supporting **x1/x4/x8** adapters at full speed. One slot is full height, half length. The other is low profile. Each is convertible to one PCI-X/133 MHz using the riser option. High-performance x16 Gen 2 slots are ideal for digital media, 2D graphics environments

PCI Express is a high-performance, low-latency, next-generation serial I/O bus that is rapidly

⁶ Data transfer rates depend on many factors and are often less than the maximum possible.

replacing the older parallel PCI and PCI-X buses. A **x16** PCIe adapter offers approximately eight *times* the maximum throughput of a 133MHz PCI-X adapter⁷. (A **x1** adapter offers throughput similar to a **66MHz** PCI-X slot.)

There is a built-in riser card in x3550 M2 that provides a PCIe connector (x8 connector wired with x4 lanes) for an internal RAID card (MR10i plus one USB connector reserved for an internal USB Flash memory key to support Hypervisor.. There is no internal Tape drive support in x3550 M2.

Dual Gigabit Ethernet Controllers

The x3550 M2 includes **two** integrated **Broadcom 5709** Gigabit Ethernet controllers for up to 10X higher maximum throughput than a 10/100 Ethernet controller, as well as support for **Jumbo Frames** and **TOE** (TCP Offload Engine).

Jumbo Frames—those larger than the standard frame (packet) size of 1,500 bytes—can be more efficient, dramatically increasing network performance and reducing server CPU overhead. **TOE** helps improve overall system performance by offloading TCP/IP protocol processing from the system microprocessor to the onboard Ethernet TOE processor. There is no additional charge for this capability.

It also supports highly secure remote power management using **IPMI 2.0**, plus **Wake on LAN**[®] and **PXE** (Preboot Execution Environment) flash interface. Optional PCI adapters offering failover and load balancing between adapters are available for added throughput and increased system availability.

Integrated Quad GbE Ports via Broadcom 5709 GbE Controller.

- Up to four (4) GbE ports ideal for virtualization and I/O intensive workloads
- 2 ports standard plus two additional ports optional via adapter card
- Improves system performance by offloading protocol processing from CPU to a separate TOE engine
- Primary performance improvement for data copying (CPU) where CPU utilization is 90-100%
- The embedded NIC/TOE supports software iSCSI using a Microsoft iSCSI initiator
- Using a software initiator enables offloading the processing of TCP frames with the TOE engine in the adapter card but the processing of iSCSI packets themselves is not hardware offloaded at the Broadcom NIC
- Broadcom hardware offloaded iSCSI (using TOE engine) of the iSCSI frames
- iSCSI and RDMA are not supported

Two Broadcom 5709 Gigabit Ethernet Controllers (one on-board and one on optional daughter card) provide four Gigabit ports supporting IEEE 802.3 for 1000Base-T, 100Base-TX, and 10Base-T applications (802.3, 802.3u, 802.3ab) through a RJ-45 connector to an Ethernet network over a CAT 5 twisted-pair cable. This controller supports PXE 2.0 remote boot, TCP/IP Offload Engine (TOE), Internet SCSI (iSCSI), Remote Direct Memory Access (RDMA), and jumbo frames (9KB). License key will be required to enable iSCSI and RDMA feature. There are two green LEDs on the connector: Activity LED on the upper left side and Link Status LED on the upper right side (viewed facing the connector). TOE support on Windows is available today. But it requires Windows Scalable Network Pack (SNP) installation. Linux has no plan to support TOE at this time. Please refer to **TOE_RDMA_iSCSI.doc** for technology details. Internet Protocol version 6 (IPv6) is supported.

Ultra-Efficient Cooling

Strategically located fans, combined with efficient airflow paths, provide highly effective system cooling for the x3550 M2, known as **Calibrated Vektored Cooling**. The base server with one power supply includes six hot-swap fan packs for redundant cooling. Each pack includes two back-to-back fans with counter-rotating blades for a total of 12 fans. In addition, each power supply also contains a fan.

The system contains **three cooling zones**. **Zone 1** (incorporating two fan packs) cools all 16 DIMM sockets, **Zone 2** (two fan packs) cools the primary processor, and **Zone 3** (one or two fan packs) cools the second processor (if installed).

The fans automatically adjust speeds in response to changing thermal requirements depending on the zone and internal temperatures. When the temperature inside the server increases, the fans speed up to maintain the proper ambient temperature. When the temperature returns to a normal operating level, the fans return to their default speed. In addition, the **Bosch BMP085 altimeter** works in conjunction with IMM to govern fan rotation. At high altitudes the air is thinner



⁷ Actual throughput will depend on the adapter vendor's implementation.

and doesn't cool as well as at lower elevations. In most servers, the fans run fast all the time to allow for use at high elevations, wasting power. The altimeter allows the IBM fans to run at lower speeds at lower altitudes.

Why not simply run the fans at 100% capacity all the time? For several good reasons: to reduce the ambient noise, reduce the wear-and-tear on the fans and reduce the server power draw. The reduction in ambient noise and power draw may be relatively minor for a single server, but put dozens or hundreds in a data center and it can make a big difference!

In addition, the server uses **hexagonal ventilation holes** in the chassis. Hexagonal holes can be grouped more densely than round holes, providing greater airflow through the system cover.

This cooling scheme is important because newer, more powerful processors generate a significant amount of heat, and heat must be controlled for the system to function properly.

There are temperature sensors on the planar placed to sense DIMM exhaust temperature, SAS HDD exhaust temperature, and CPU2 exhaust temperature (through the altitude sensor).

Light Path Diagnostics

Light path diagnostics enables a technician to quickly identify and locate a failed or failing system component, such as a specific fan or memory DIMM. This enables quick replacement of the component, which helps increase server uptime and lower operating costs.



The front of the server has an LED indicator light to show possible component failures. If the front LED indicates an error condition, by pressing a button on the front of the server an LED panel will pop out and drop down for easy viewing without the need to open the server cover or remove the server from the rack. The light path diagnostics panel tells the servicer which component requires attention. In addition, many components have their own identifying LEDs. For example, each of the eight memory modules has an LED next to the socket, as do both processors, all adapter slots, all fans, all power supplies, the voltage regulator module and the service processor, allowing the servicer to easily identify exactly which component needs servicing. By following the "light path," the component can be replaced quickly, and without guesswork. (**Note:** In the event of a failed DIMM, the system will restart and mark the DIMM as bad while offline, thus allowing the system to continue running, with reduced memory capacity, until serviced.)

Hot-Swap/Redundant Components

System availability is maximized through the extensive use of hot-swap and redundant components, including:

- **Redundant memory protection** (with **memory mirroring** enabled)
 - **Hot-swap, redundant hard disk drives** (with **RAID-1/10** protection standard and three other RAID levels optional)
 - **Hot-swap, redundant power supplies**
 - **Hot-swap, redundant cooling fans**
-

Other Features

- **Four USB 2.0 ports** — Provides flexibility to add high-speed external devices. The USB 2.0 specification supports up to 480Mbps transfer rates. (**Note:** Not all USB 2.0 devices are capable of achieving this rate.) Two ports are provided on the front of the server and four on the back. USB ports can be used for pre-boot to an external drive, also for KB/mouse
 - **Embedded hypervisor** via a USB connector on the motherboard) activated with an optional 2GB USB key; for supporting VMware ESXi for virtualization (available 2Q/09)
 - **Virtual Media Key** — This optional full-function systems management adapter adds local and remote management functions without consuming a valuable adapter slot.
 - **Dual video ports** — A **Matrox G200eV** SVGA video controller provides up to **1024x768** resolution, with a color depth of **32 bits** at **85Hz** refresh rate. To simplify local systems management, **one** video port is provided on the front of the unit and **one** on the back.
 - **Toolless slides** — Allows quick rack installation and quicker upgrade and servicing of the server.
 - **Toolless chassis** — The cover can be opened without tools, and many components can be removed and replaced without tools, including the CD-RW/DVD combo drive, hot-swap HDDs, plus PCI, PCI-X and PCIe adapters, as well as the integrated ServeRAID BR10i and Virtual Media Key. This can save a servicer significant time.
-

Rack Cable Management and KVM Console Switching

IBM Advanced Cabling Technology (ACT) is an optional feature that offers many advantages over standard KVM cabling across the entire System x product line. So now you can interconnect all of your servers with one smart cabling architecture. ACT cabling eliminates the need for one-to-one direct connections between each server and a KVM switch by using a daisy-chain approach.

The snarl of cabling behind most racks is at best inconvenient to work around and at worst an expensive logistical nightmare, requiring the rewiring of servers, PDUs, KVM switches, and other equipment whenever a rack server is added or removed. Even worse, the veil of cables blocks rack airflow and can actually contribute to equipment failure due to overheating. ACT cabling is the solution for reducing behind-the-rack cabling by as much as **87%**.

The illustration below shows a sample ACT configuration:

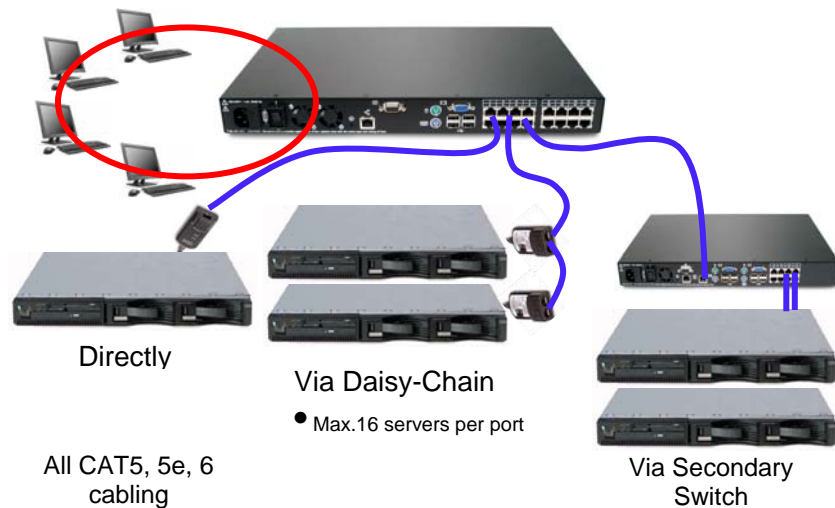

Conventional cabling has bulky KVM cables exiting each server, which then connect to a KVM switch. The cables exiting a series of KVM switches must then be aggregated via additional KVM switches and PDUs, which only increases the number—and cost—of cables, KVM switches and PDUs. Instead, the daisy-chain approach of ACT cabling uses readily available, inexpensive CAT5 and 6 cabling to considerably *reduce* the number of cables, KVM switches, and PDUs needed, rather than increasing them. If a server is removed or added, no complicated rewiring is needed. One cable connects the first server in the rack to the next, and so on. Up to **16** servers form a chain; up to **8** chains can connect to one Local Console Manager (LCM); **16** LCMs can connect to one Global Console Manager (GCM). In this manner, up to **2,048 servers** can be centrally managed. Equally importantly, with ACT—unlike some other offerings—everything is done externally via cabling; *no* special adapters are required.

Extensive System Support Features

The IBM services and technical support portfolio provides world-class, consistent, high-quality service and support. The x3550 M2 server offers a number of tools and services designed to make ownership a positive experience. From the start, IBM programs make it easier for you to plan for, configure and purchase System x servers, get them running and keep them running long-term. These features include IBM Express Portfolio, IBM ServerProven[®], IBM Standalone Solutions Configuration Tool, IBM System x and BladeCenter Power Configurator, IBM ServerGuide, IBM Electronic Service Agent[™], Product Customization Services and extensive technical support offerings.



The IBM **ServerProven** program provides the confidence that specific options and operating systems have been tested on the server and are officially supported to work together. It is updated frequently to ensure that the latest compatibility information is always at your fingertips.

The IBM **Standalone Solutions Configuration Tool** (SSCT) is a downloadable tool that simplifies the often complex chore of configuring a full rack of servers (including blade servers) and confirming that you have all the cables, power distribution units, KVM (keyboard, video and mouse) switch boxes and other components you need, as well as the proper airflow clearances, electrical circuits and other environmental conditions.

IBM **System x and BladeCenter Power Configurator** helps IT managers plan for data center

power needs, by providing the following information for specific configurations of System x and BladeCenter systems: *power input* (watts), *PDU sizing* (amps), *heat output* (BTUs), *airflow requirements through chassis* (CFM), *VA rating*, *leakage current* (mA), and *peak inrush current* (amps).

IBM **ServerGuide** (installed from CD) simplifies the process of installing and configuring System x servers. ServerGuide goes beyond mere hardware configuration by assisting with the automated installation of the Microsoft® Windows® Server 2000 and 2003 operating systems, device drivers and other system components, with minimal user intervention. (Drivers are also included for support of Novell NetWare, Red Hat Linux and SUSE LINUX.) This focus on deployment helps you reduce both your total cost of ownership and the complexity that administrators and technical personnel face.

IBM Systems Director Service and Support Manager (previously called IBM Electronic Service Agent™) is an innovative “call home” feature that allows System x and BladeCenter servers to automatically report hardware problems to IBM support, which can even dispatch onsite service⁸ if necessary to those customers entitled to onsite support under the terms of their warranty or an IBM Maintenance Agreement. Electronic Service Agent resides on a server and provides electronic support and problem management capabilities through a highly secure electronic dialogue between your systems and IBM. It monitors networked servers for hardware errors and it can perform hardware and software inventories and report inventory changes to IBM. All information sent to IBM is stored in a highly secure database and used for improved problem determination.

Additional services include hardware warranty upgrades and factory-installed **Product Customization Services** (PCS), such as asset tagging, hardware integration, software imaging and operating systems personalization.

IBM offers extensive **technical support** by phone and via the Web. Support options include links to forums/newsgroups, problem submission, online shopping support, service offerings, device drivers for all IBM product lines, software downloads and even upcoming technical seminar worldwide schedules and registration. Also available are remote installation, configuration and usage support for System x hardware and software, as well as onsite custom services to provide the level of expertise you require.

Advanced Systems Management Capabilities

The x3550 M2 has a high level of systems management capabilities that are well-suited to remote locations as well as to stand-alone environments. Features include **UEFI**, **IMM**, ToolsCenter, IBM Systems Director Active Energy Manager for x86, Automatic Server Restart, Wake on LAN® support, PXE support, text console redirect, Predictive Failure Analysis, IBM Systems Director and support for an optional Remote Supervisor Adapter II SlimLine.

The **IMM** provides industry-standard **Intelligent Platform Management Interface (IPMI) 2.0**-compliant systems management. It provides a number of important system functions, including:

- Monitoring of system and battery voltage, system temperature, fans, power supplies, processor and DIMM status
- Fan speed control
- Product ID and Family ID detection
- Highly secure remote power on/off
- System reset control
- NMI/SMI detection and generation
- System diagnostic LED control (power, HDD, activity, alerts, heartbeat)
- IPMI over LAN
- Serial Over LAN
- Proxy server support
- LAN messaging and alerting
- Text console redirection over LAN
- VLAN support
- Enhanced authentication and encryption algorithms (RMCP+, SHA-1, AES)
- Local update of BMC firmware
- Firmware firewall
- Support for IPMI v2.0 compliant management software (e.g., xCAT)
- Other mandatory and optional IPMI BMC functions

⁸ For onsite labor, IBM will attempt to diagnose and resolve the problem remotely before sending a technician.

Leadership enterprise server with significantly lower cost of ownership in a highly available and expandable, rack-dense, 1U dual-socket server

The IMM alerts IBM Systems Director to anomalous environmental factors, such as voltage and thermal conditions—even if the server has failed.

The x3550 M2 also supports an optional IBM Virtual Media Key for additional systems management capabilities, including:

- Predictive Failure Analysis for system fans
- Graphical console redirection over LAN
- Web-based out-of-band control
- Windows “blue screen” capture
- Remote virtual floppy and CD-ROM
- High-speed remote redirection of PCI video, keyboard and mouse
- SSL (Secure Socket Layer) and LDAP (Lightweight Directory Access Protocol) support

IBM developed IBM **Systems Director Active Energy Manager for x86** to put control of system power-saving features at the fingertips of administrators. Active Energy Manager is designed to take advantage of new features, such as monitoring power usage and balancing the performance of the system according to available power input. It provides the ability to plan and predict power consumption based on your hardware configuration. It also helps enable you to reduce the infrastructure required for redundancy, by using fewer servers on smaller power feeds and potentially lowering your overall data center support costs. It does this by inventorying all components, then adding up the total power draw and tracking the usage. It also includes power management and capping features to help administrators manage or reduce power usage.

Automatic Server Restart (ASR) helps reduce downtime by restarting the server automatically in the event of a system lockup. ASR technology is a combination of hardware circuitry tied into the server’s system reset function and a device driver. As long as the server continues running, the ASR watchdog timer will keep being reset, but if the operating system crashes or the hardware freezes somehow the ASR software will be unable to reset the hardware timer. If the timer is not reset within five minutes, it automatically triggers the ASR hardware, which immediately restarts the server (and logs an ASR event with IBM Systems Director). These features are designed so that *no more than five minutes can pass before the server is restarted*.

Wake on LAN permits the server to be remotely powered on if it has been shut off. Once powered up, the server can be controlled across the network, using the **Preboot Execution Environment (PXE)**.

Like Wake on LAN, PXE is system firmware. It enables software such as the optional **IBM Remote Deployment Manager** to take control of a system before the BIOS, operating system or applications are loaded (using Wake on LAN/PXE) and lets an administrator perform many low-level tasks remotely that would otherwise require a visit to each system. These tasks may include such things as formatting a hard disk drive, updating system firmware, or deploying a Windows or Linux operating system.

Text Console Redirection support allows the administrator to remotely view x3550 text messages over serial or LAN. An optional upgrade to the Virtual Media Key adds graphical console redirection.

Predictive Failure Analysis (PFA) is designed to allow the system to detect impending failure of supported components (memory, power supplies, hard disk drives, and fans) *before* actual failure, and alert the administrator through IBM Systems Director. This gives you the ability to *replace* the failing component *before* it fails, resulting in increased uptime.

IBM Systems Director software for advanced workgroup management is included with the x3550 M2. IBM Systems Director comes with a portfolio of tools, including *Management Processor Assistant, Rack Manager, RAID Manager, Update Assistant and Software Distribution. Systems Director Active Energy Manager for x86, System Availability* (a no-charge download) and *Capacity Manager* (sold separately) are available as add-ons for additional server management and increased availability. IBM Systems Director provides a single uniform graphical interface for all of these systems management functions.

IBM Systems Director enables you to customize thresholds and monitor system components (for things like temperature, voltage regulation, etc.) to help maximize uptime.

Key Options

IBM options for System x servers help you take your servers to a higher level

You know can rely on System x options to supply a complete solution for your business needs. Options help you create an optimized server system to meet your data protection, storage and availability needs. Every IBM option is designed and tested for peak performance and flexibility, helping to maximize your return on investment. The combination of System x servers and options

lets you keep your fingers on the pulse of your e-business.

Processors — The Intel Xeon processor provides high clock rates, dual- or quad-cores, 64-bit extensions, a large cache and advanced features for availability and manageability. Large cache size, combined with a fast **1333MHz** or **1066MHz** front-side bus, reduces memory latency and facilitates the movement of data through the processor and I/O devices. (**Note:** System performance depends not only on the number of processors in the server but also on the power and functionality of each processor.) Adding a second processor may be a cost-effective way to achieve significant performance improvements.

Memory — Memory is a significant factor in systems application performance. Adding more memory to a System x server is one of the most effective ways to increase application performance. For best performance in a server with a dual-core processor, there should be twice as much memory available as for a single-core processor.

Hard Disk Drives — IBM hard disk drives help you improve the transaction and cost performance of your System x servers. The choice of hard disk drives can be a critical aspect of maximizing the I/O throughput of the system. **SAS** hard disk drives are available for the x3550 M2 with capacities up to **300GB** (2.5-inch) apiece at **10,000** RPMs, up to **146.8GB** (2.5-inch) apiece up to **15,000** RPMs, or up to **73.4GB** (2.5-inch) at **15,000 RPM**.

Power Supply — The optional second power supply for the x3550 M2 enables redundancy for hot-swap power.

Virtual Media Key — The x3550 M2 includes a plethora of systems management features built-in; however, sometimes additional management capability is needed. In those situations, the Virtual Media Key not only offers powerful new features, it does so without taking up a valuable PCI-X or PCIe adapter slot, instead using a dedicated slot on the motherboard.

ServeRAID Controllers — System x servers using ServeRAID BR10i technology allow companies to build a reliable foundation for business-critical computing. IBM ServeRAID technology allows an array consisting of multiple physical hard disk drives to be treated as one logical drive. ServeRAID technology also allows data to be stored redundantly, across multiple hard disk drives—enhancing both the integrity and the availability of the data. SAS and SATA ServeRAID controllers offer enhanced performance due to onboard processors and cache. Because IBM ServeRAID controllers can help significantly improve data transfer rates, this technology is extremely effective when implementing demanding, transaction-oriented applications. By employing the advanced fault tolerance of IBM ServeRAID technology, companies can effectively implement networked business systems that require large amounts of storage space for data and applications that must be available for their businesses to continue operating.

The optional MegaRAID-MR10i SAS/SATA controller offers enhanced performance over the integrated ServeRAID BR10i controller (SAS models), **256MB** of battery-backed cache memory, and supports **six** RAID levels: **0** (striping), **1** (mirroring), **10** (mirroring and striping), **1E** (enhanced mirroring, supporting odd numbers of drives), **5** (striping with parity), and **6** (striping with double parity).

The optional MegaRAID MR10is supports hardware based full disk encryption plus **RAID-0/1/10/1E/5/6** support.

The optional MegaRAID MR10M SAS controller offers high performance and **256MB** of cache memory (with optional battery backup) for *external* SAS storage capacity. The adapter supports **five** RAID levels: **0** (striping), **1** (mirroring), **10** (mirroring and striping), **5** (striping with parity), and **50** (striping/mirroring with parity).

External Storage — The IBM System Storage **DS3000**, **DS4000**, **DS6000**, and **DS8000** series, as well as the **N3000**, **N5000**, and **N7000** series, comprise a powerful and broad shared storage family with integrated management software designed to meet midrange and enterprise needs. For lower-end needs, IBM offers the System Storage **DS400** storage enclosure.

External SAN, iSCSI, and direct-attach storage is available using one of several IBM System Storage and TotalStorage host bus adapters. Additionally, external LAN-attached tape storage is available.

The **iSCSI HBA Adapter for IXA Connectivity** is a PCI adapter for selected System x servers that provides a direct **1GBps** link to an IBM System i5 server. This connection enables you to centralize your Microsoft Windows and System i5 storage and consolidate the operations and backup of your System x, and System i5 systems into a single infrastructure. It enables the tightest possible integration between Windows and System i5/iSeries data and applications, and allows as many as **32** servers to attach to one System i5 system to share the iSeries server's systems management, DVD, tape and disk storage via the iSeries dynamic virtual storage architecture. This can take the place of a SAN if you have an established System i5 infrastructure.

Leadership enterprise server with significantly lower cost of ownership in a highly available and expandable, rack-dense, 1U dual-socket server

IBM System x3550 M2 Images

Front View

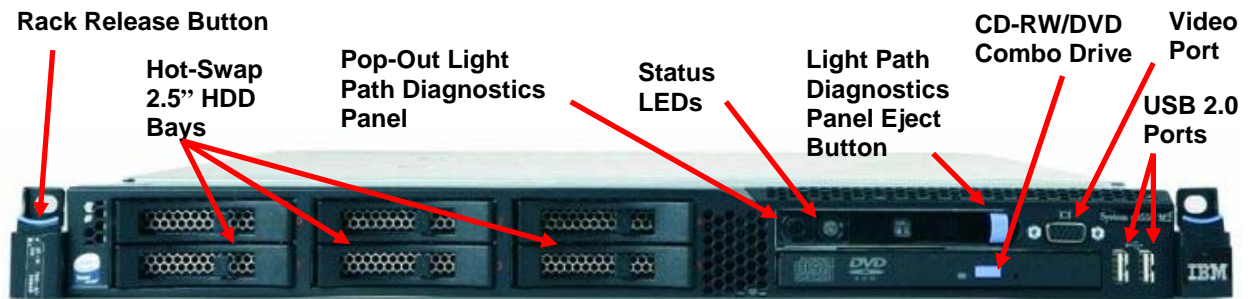

Inside View

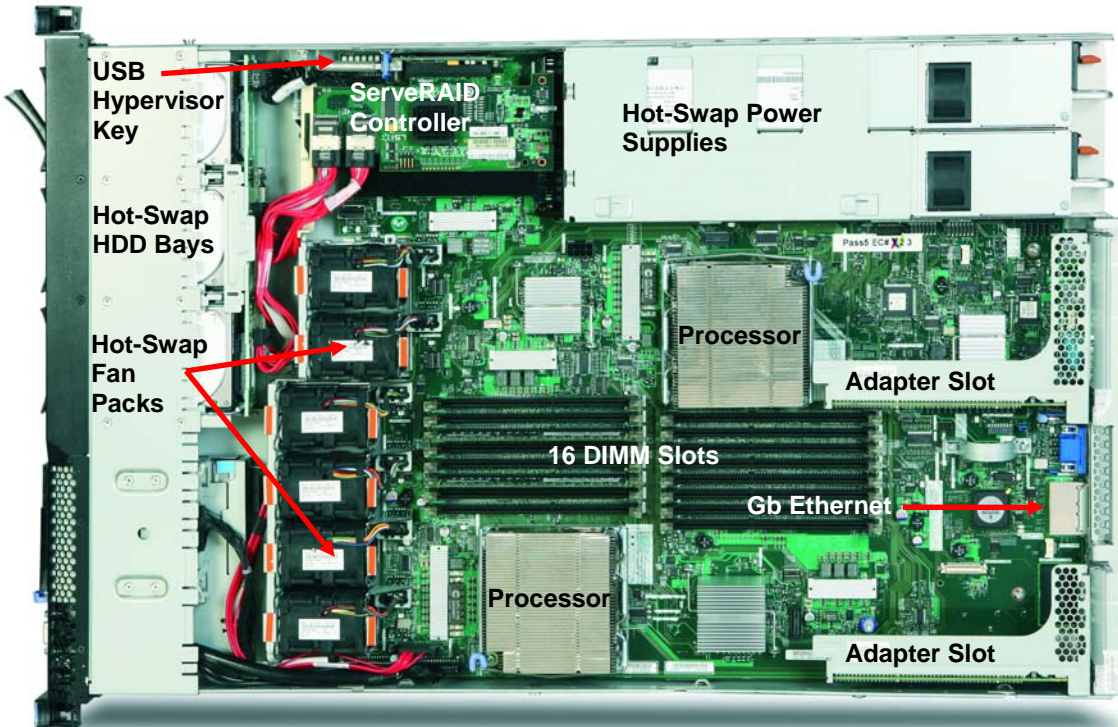

Rear View

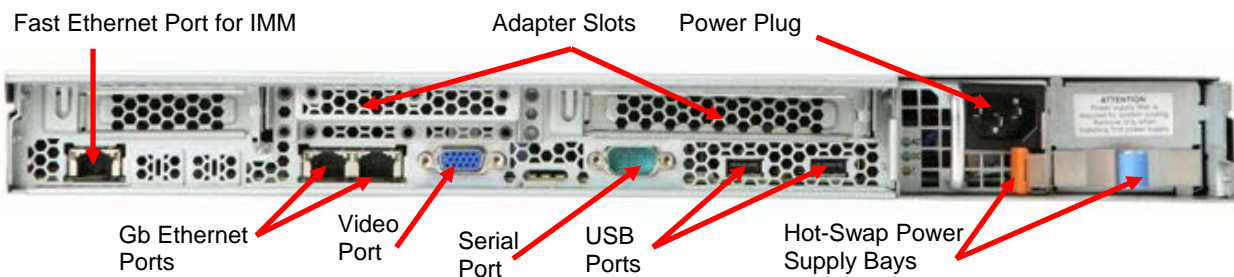

Please see the Legal Information section for important notices and information.

Leadership enterprise server with significantly lower cost of ownership in a highly available and expandable, rack-dense, 1U dual-socket server

IBM System x3550 M2 Specifications			
Machine type	7946 -12x, -22x, -3Ax, -32x, -42x, -52x, -62x, -92x		
Form factor	1U		
Processor type	Quad-core Xeon E5504 @2.0GHz (-22x), E5506 @2.13GHz (-3Ax), E5520 @2.26GHz (-32x), L5520 @ LV2.26GHz (-42x), E5530@2.4GHz (-52x), E5540 @2.53GHz (-62x), X5570 @2.93GHz (-92x), other processors supported via CTO		Dual-core Xeon E5502 @1.86GHz (-12x)
Maximum processor power draw	60W (-42x)	80W (-12x, -22x, -3Ax, -32x, -52x, -62x)	95W (-72x, -92x)
# of processors standard / maximum	1 / 2		
Internal L2 cache	4MB (1 x 4MB shared cache) -12x, -22x, -3Ax	8MB (2 x 4MB shared cache) -32x, -42x, -52x, -62x, -92x	
Chipset	Intel 5520		
Standard / maximum memory⁹	2GB or 4GB / Max. 128GB		
Standard memory type	Registered PC3-10600 DDR III ECC (Chipkill protection with x4 DIMMs)		
Memory interleaving	Yes (four-way using multiples of 4 DIMMs; two-way otherwise)		
DIMM capacities supported	1GB, 2GB, 4GB, 8GB		
# of DIMM sockets total / available	16 (8 per processor)		
Memory mirroring supported / # of DIMM sockets reserved for mirroring	Yes / 4		
# of drive bays total / available	6 / 6 (all models)		
# of HDD drive bays total / available	6 / 6 2.5-inch (all models)		
# of 5.25" bays total / available	1 / 0 (CD-RW/DVD installed)		
Maximum drive capacity	2.5-inch SAS/SATA 1.8TB (6 x 300GB) hot-swap		2.5-inch SSD 300GB (6 x 50GB) hot-swap
Drive capacities supported	2.5-inch SAS 73.4, 146.8, 300GB —10K 73.4, 146.8GB —15K	2.5-inch SATA 300GB —10K	2.5-inch SSD 31.4, 50GB
# of HDDs standard	None (all models open bay)		
# of optical drives standard	1 CD-RW/DVD Combo (24X/24X/24X/8X, in dedicated 5.25" UltraBay)		
# of diskette drives standard	None (optional)		
Internal tape drives supported	None (externally attached)		
Disk drive technology	Hot-swap SAS/SATA/SSD; also simple swap SSD		
External disk drives supported	Yes, via MegaRAID MR10M controller		
Integrated RAID controller	ServeRAID BR10i std (all models)		
Optional RAID controllers supported	Choice of 4 - ServeRAID-BR10i, MR10i, MR10is, MR10M		
# of adapter slots total / available	2 / 2		

⁹ Maximum memory and disk capacity may require the replacement of standard components with the largest supported component available.

Leadership enterprise server with significantly lower cost of ownership in a highly available and expandable, rack-dense, 1U dual-socket server

IBM System x3550 M2 Specifications		
# of PCIe x16 slots (5GBps)	2 (standard)	
# of PCI-X/133 slots (1GBps)	2 (optional in place of PCIe slot)	
# of 33MHz legacy PCI slots	None	
# of video ports	2 (one front, one rear)	
Video controller	Matrox G200eV (in IMM)	
Video memory	16MB SDRAM	
Maximum video resolution at 32-bit color	1280x1024 32-bit color at 60Hz	
Gigabit Ethernet controller	Broadcom BCM5709	
# of Gigabit Ethernet ports	2 standard plus 2 optional	
# of RS485 ports	None	
# of serial ports	1 (rear)	
# of parallel ports	None (USB-attached)	
# of mouse ports	None (USB-attached)	
# of keyboard ports	None (USB-attached)	
# of USB 2.0 ports	5 ports (2 front, 2 rear, 1 internal for optional USB Flash memory key to support Hypervisor on some models)	
Integrated systems management controller	Yes (IMM)	
Optional systems management adapter	Virtual Media Key (optional)	
Light path diagnostics support	Yes, with external pop-out/drop-down panel	
Predictive Failure Analysis support	Processors, memory, voltage regulator modules (VRMs), HDDs, power supplies (plus fans, when an optional Remote Supervisor Adapter SlimLine II is used)	
Power supply size	675W universal, autoswitching, hot-swap	
# of power supplies standard / maximum	1 / 2	
Hot-swap/redundant power supported	Yes (with two power supplies installed)	
# of fan modules/blowers standard / maximum	6 (with one processor installed)	6 (with two processors installed)
Hot-swap/redundant fans supported	Yes (standard)	
Rack mount method	Slides and Cable Management Arm (provided standard)	
Maximum altitude	7,000 ft; 2,133 m	
Operating temperature range	50 – 95° F; 10 – 35° C (up to 3,000 ft / 914.4 m)	50 – 90° F; 10 – 32° C (3,000 ft to 7,000 ft / 914.4m to 2,133m)
Dimensions (HWD) / weight	1.7" (43mm) H 17.3" (440mm) W 28.0" (711.4mm) D	28 (minimum) – 34.5 lb (maximum) 12.7 – 15.6 kg
Operating systems supported	Microsoft Windows Server 2003 R2 (Standard/Web/Enterprise Editions) 32/64-bit, Microsoft Windows 2000 Server (Standard/Enterprise Editions), Microsoft Small Business Server Standard Edition, RHEL 4/5 32/64-bit, SLES 10 32/64-bit, Novell Open Enterprise Server (NetWare 6.5), VMware ESX Server 2.5/3.0	

Leadership enterprise server with significantly lower cost of ownership in a highly available and expandable, rack-dense, 1U dual-socket server

IBM System x3550 M2 Specifications

Length of limited warranty

3 years (parts and labor)¹⁰

The Bottom Line

The IBM System x3550 M2 is an extremely energy efficient, powerful system, incorporating significantly redesigned management tools and abundant IBM-unique innovations:

Price/Performance

- **High-throughput processors** — **2.0 to 2.96GHz quad-core** or **1.8GHz dual-core** Xeon processors; up to 2 quad-core or dual core) **processor cores** total
- **Energy-efficient low-voltage processors** — **60W quad-core** Xeon processors
- **Large cache** — **8MB** or **4MB** of L3 processor cache
- **64-bit extensions** (EM64T)
- **Fast memory** — **1333MHz PC3-10600 DDR III** ECC memory standard with **two-way** or **four-way interleaving**, operating at **1333MHz** or **1066MHz** or **800MHz** (depending on processor model and memory configuration)
- **Fast disk technology** — Integrated **SAS** controller and slotless hardware-based **RAID-0** data striping, **RAID-10** striped/mirrored arrays uses a slot, or **SATA** controller (model-specific)
- **Fast communications** — Integrated **dual Gigabit Ethernet** controllers standard supporting **Jumbo Frames** and **TOE**, two additional Gigabit Ethernet optional
- **Fast I/O** — Two **PCIe x16** adapter slots

Flexibility

- **Large memory capacity** — Up to **128GB** of registered DDR3 DIMMs, using 16 DIMM slots
- Up to **six 2.5-inch hot-swap SAS/SATA/SSD** drives
- **Choice of disk storage** — Up to **1.8TB** of internal SAS/SATA storage, **300GB** of internal solid-state storage
- **High-performance external expansion** — **Four** 480Mbps **USB 2.0** ports (two front, two rear)
- Hardware-based **RAID-0/1/10** support or RAID support for **RAID-1E/5/6** or **full disk encryption with RAID-1E/5/6** or **external storage**
- **Two available** adapter slots —
 - **Two x16¹¹ PCIe** slots (Gen2)
 - An optional riser card containing **one 133MHz PCI-X** slot can replace the riser card containing each of the PCIe slots
- Integrated **DVD/CD-RW** combo drive
- **Two video ports** (one on the front and one on the back)
- Optional **iSCSI HBA Adapter for IXA Connectivity** (to System i[®] servers)

Manageability, Serviceability and Availability

- **IBM Systems Director** systems management software, including:
 - IBM Systems Director Active Energy Manager
 - IBM Management Processor Assistant
 - IBM Rack Manager
 - IBM RAID Manager
 - IBM Update Assistant
 - IBM Software Distribution
 - IBM System Availability
- **Integrated Management Module (IMM):**
 - **IPMI 2.0** compliance, including highly secure remote power control
 - **Text console redirection** systems management standard
- **Active Memory protection:**

¹⁰ For terms and conditions or copies of the IBM Statement of Limited Warranty, call 800-772-2227 in the U.S. In Canada call 800-426-2255. IBM makes no representation or warranty regarding third-party products or services including those designated as ServerProven or ClusterProven. Telephone support may be subject to additional charges. For warranties including onsite labor, a technician is sent after IBM attempts to resolve the problem remotely. International warranty service is available in any country in which this product is sold.

¹¹ The x8 slots can accept x1, x4, or x8 adapters running at x1, x4, or x8 throughput, respectively.

Leadership enterprise server with significantly lower cost of ownership in a highly available and expandable, rack-dense, 1U dual-socket server

- Advanced **Chipkill** ECC memory protection, and either
- Memory mirroring**
- Slotless hardware-based **ServeRAID BR10** disk mirroring; RAID -1, 5, 6, 10, 50 uses PCIe slot
- **Hot-swap SAS /SATA/SSD** hard disk drives or **simple-swap SSD** drives
- **Ultra-efficient cooling** incorporating **Calibrated Vectored Cooling** features and **hot-swap/redundant fans**
- Optional **hot-swap/redundant power supplies**
- **Light path diagnostics** (front LED panel, drop-down light path panel)
- Optional Virtual Media Key daughter card (no slot required)
 - Supports **LDAP** and **SSL** industry standards
- **Toolless chassis** and **toolless slide** design; integrated **Cable Management Arm**

Server Comparison Chart

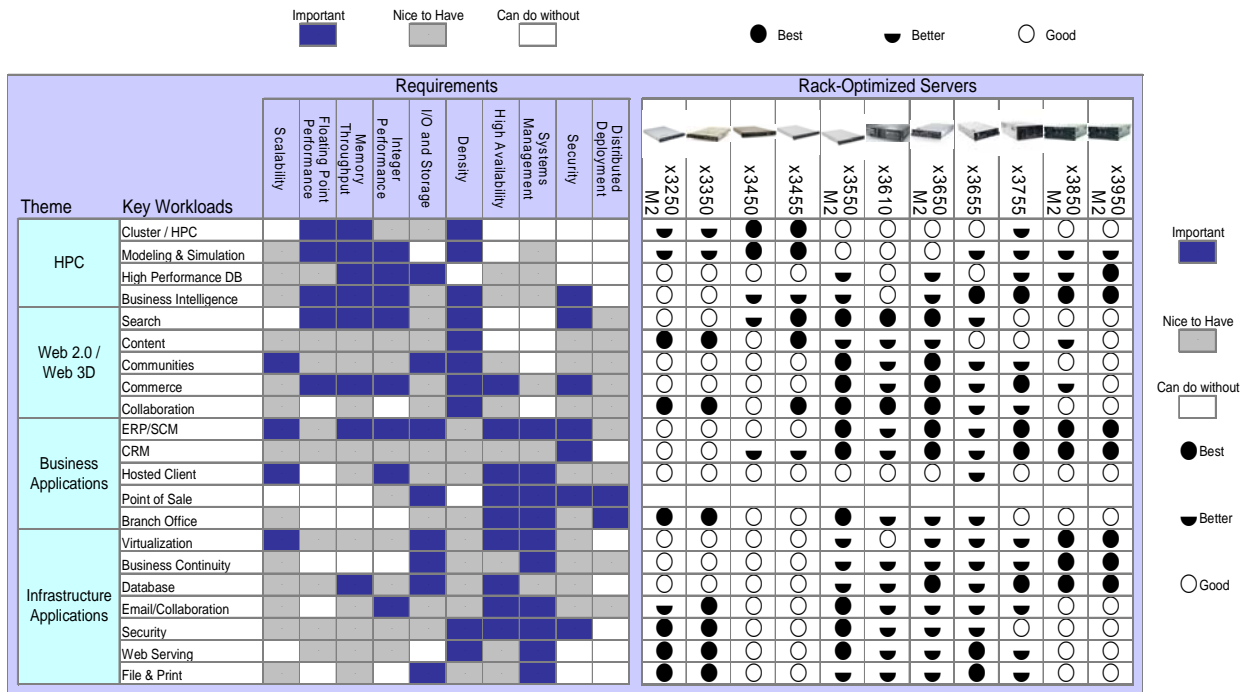

For More Information

IBM System x Servers	http://ibm.com/systems/x
Electronic Service Agent	http://ibm.com/support/electronic
IBM System x and BladeCenter Power Configurator	http://ibm.com/systems/bladecenter/powerconfig
Standalone Solutions Configuration Tool	http://ibm.com/servers/eserver/xseries/library/configtools.html
Configuration and Options Guide	http://ibm.com/servers/eserver/xseries/cog
ServerProven Program	http://ibm.com/servers/eserver/serverproven/compat/us
Technical Support	http://ibm.com/server/support
Other Technical Support Resources	http://ibm.com/servers/eserver/techsupport.html

Legal Information

© IBM Corporation 2009
IBM Systems and Technology Group
Dept. U2SA
3039 Cornwallis Road
Research Triangle Park, NC 27709

Produced in the USA
March 2009
All rights reserved

For a copy of applicable product warranties, write to: Warranty Information, P.O. Box 12195, RTP, NC 27709, Attn: Dept. JDJA/B203. IBM makes no representation or warranty regarding third-party products or services including those designated as ServerProven or ClusterProven. Telephone support may be subject to additional charges. For onsite labor, IBM will attempt to diagnose and resolve the problem remotely before sending a technician.

IBM, the IBM logo, the e-business logo, Active Memory, Predictive Failure Analysis, ServeRAID, System i, System Storage, System x, Xcelerated Memory Technology, and X-Architecture are trademarks of IBM Corporation in the United States and/or other countries, or both. If these and other IBM trademarked terms are marked on their first occurrence in this information with a trademark symbol (® or ™), these symbols indicate U.S. registered or common law trademarks owned by IBM at the time this information was published. Such trademarks may also be registered or common law trademarks in other countries. A current list of IBM trademarks is available on the Web at <http://ibm.com/legal/copytrade.shtml>.

Linux is a registered trademark of Linus Torvalds.

Microsoft, Windows and the Windows logo are trademarks or registered trademarks of Microsoft Corporation.

Other company, product and service names may be trademarks or service marks of others.

IBM reserves the right to change specifications or other product information without notice. References in this publication to IBM products or services do not imply that IBM intends to make them available in all countries in which IBM

operates. IBM PROVIDES THIS PUBLICATION "AS IS" WITHOUT WARRANTY OF ANY KIND, EITHER EXPRESS OR IMPLIED, INCLUDING THE IMPLIED WARRANTIES OF MERCHANTABILITY AND FITNESS FOR A PARTICULAR PURPOSE. Some jurisdictions do not allow disclaimer of express or implied warranties in certain transactions; therefore, this statement may not apply to you.

This publication may contain links to third party sites that are not under the control of or maintained by IBM. Access to any such third party site is at the user's own risk and IBM is not responsible for the accuracy or reliability of any information, data, opinions, advice or statements made on these sites. IBM provides these links merely as a convenience and the inclusion of such links does not imply an endorsement.

Information in this presentation concerning non-IBM products was obtained from the suppliers of these products, published announcement material or other publicly available sources. IBM has not tested these products and cannot confirm the accuracy of performance, compatibility or any other claims related to non-IBM products. Questions on the capabilities of non-IBM products should be addressed to the suppliers of those products.

MB, GB and TB = 1,000,000, 1,000,000,000 and 1,000,000,000,000 bytes, respectively, when referring to storage capacity. Accessible capacity is less; up to 3GB is used in service partition. Actual storage capacity will vary based upon many factors and may be less than stated.

Performance is in Internal Throughput Rate (ITR) ratio based on measurements and projections using standard IBM benchmarks in a controlled environment. The actual throughput that any user will experience will depend on considerations such as the amount of multiprogramming in the user's job stream, the I/O configuration, the storage configuration and the workload processed. Therefore, no assurance can be given that an individual user will achieve throughput improvements equivalent to the performance ratios stated here.

Maximum internal hard disk and memory capacities may require the replacement of any standard hard drives and/or memory and the population of all hard disk bays and memory slots with the largest currently supported drives available. When referring to variable speed CD-ROMs, CD-Rs, CD-RWs and DVDs, actual playback speed will vary and is often less than the maximum possible.

XSO03059-USEN-01

Free Manuals Download Website

<http://myh66.com>

<http://usermanuals.us>

<http://www.somanuals.com>

<http://www.4manuals.cc>

<http://www.manual-lib.com>

<http://www.404manual.com>

<http://www.luxmanual.com>

<http://aubethermostatmanual.com>

Golf course search by state

<http://golfingnear.com>

Email search by domain

<http://emailbydomain.com>

Auto manuals search

<http://auto.somanuals.com>

TV manuals search

<http://tv.somanuals.com>